

PILOT

Precision Products

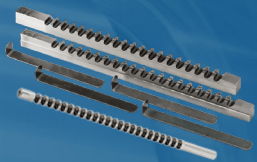

- Keyway Broaches
- Push Broaches
- Pull Broaches

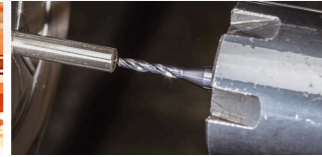
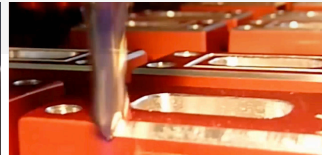
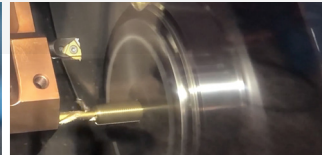
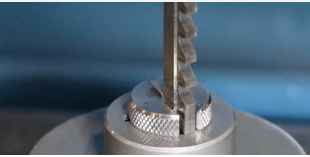

- Punch Broaches
- Hex/Square Broaches
- Tool Holders

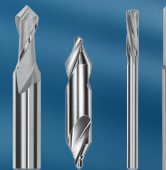

- Center/Spot Drills
- Countersinks/
Multi-Function Tools
- Carbide Reamers



- Cobalt Micro-Drills
- Quality Carbide Micro-Drills
- High-Performance Carbide Micro-Drills

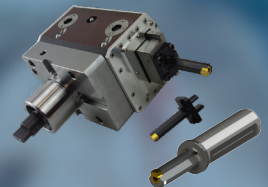

- Indexable Broaches
- Tooling Inserts
- Motorized Slotters



TOOLING CONCIERGE

For Your Machining Operations

PilotPrecision.com

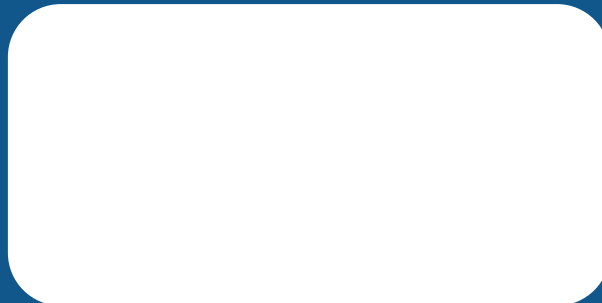

Best-in-class brands, outstanding customer service and fast, reliable delivery

Pilot Precision Products is the World's largest supplier of industrial broaches and small, round cutting tools from duMONT MinuteMan® Industrial Broaches, Hassay Savage, duMONT CNC Indexable Broaching System, Magafor® and GMauvaisUSA™.

Pilot Precision Products balances time-honored traditions with innovative manufacturing techniques in all its offerings. As a result, customers can trust that the exceptional customer service from each company will remain the same.



World's largest supplier of keyway broaches

The duMONT Company has been designing and manufacturing precision broaches since 1945. Minute Man® Broaches are recognized all over the world for quality, durability and engineering detail. All are manufactured of the finest quality high-speed steel.

duMONT CNC Indexable Broaching System

The duMONT CNC Indexable Broaching System offers a wide range of products that provide the opportunity to manufacture parts more efficiently and accurately through single machine processing. This includes CNC Lathes, Milling Machines, Motorized Slotter and many CNC Broaching Systems. To complement all tools we offer many accessories to make your project run effortless.



World's leader and largest supplier in center drills, spot drills, micro to standard size reamers, countersinks, multi-function tools and micro end mills

Magafor can resolve any centering, chamfering, micro-milling or reaming issues you may be experiencing with top-quality products available in HSS-Cobalt or Carbide. Their Multi-V can reduce machining times and tool set-ups; one tool, one holder, ten applications. Pilot is the exclusive American distributor of Magafor products.

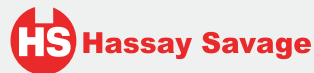

World's leader in rotary and index broaching

Hassay Savage products have five decades of engineering expertise behind them. If you're looking for critically accurate cuts, look no further. Choose from push, pull and rotary broaches with TiN and TiAlN coating. Big jobs come in small parts. Let us be your partner in unique cutting applications.



Highly specialized precision micro drills

GMauvaisUSA™ is known worldwide for superior precision, quality, consistency and performance. Notably, micro drills from the brand afford extraordinary concentricity, circularity and straightness within .00008". As the exclusive American distributor of GMauvais products, Pilot can bring GMauvaisUSA™ precision to you and your projects.

In addition to our robust off-the-shelf product offerings, customers often call on us for custom tooling. When such a request comes in, we never shy away from that challenge. In fact, we enjoy working to create a unique and highly productive solution.



duMONT

Minute Man[®]

Industrial Broaches



Hassay Savage

Rotary Broaches & Tool Holders

PILLOT

Table of Contents

Introduction	5
Keyway Broach Sets	6-8
Metric Keyway Broach Sets	9
Imperial Keyway Sizes	10-12
Metric Keyway Sizes	13-15
Additional Sizes - Imperial & Metric - Keyway	16
One-Pass Keyway Broaches	17
Production Push-type Keyway Broaches	18
Square Push Broaches	19
Full Square Push Broaches	20
Round Push Broaches	20
Hexagon Push Broaches	21
Pull-Type Keyway Broaches	22-23
Keyseating Broaches	24
Arbor Presses and PressLube Broaching Oil	25
Custom Broaches (Spline, Keyway, Firearms)	26
Custom Broaches and Re-Sharpening (Surface, Internal Hole)	27
Engineering	28-30
To the Distributor	31

PILLOT

A Reputation for Excellence

The duMONT and Hassay Savage Companies have been designing and manufacturing Precision Broaches for decades, and these Broaches are recognized all over the world for their quality, durability and engineering detail.

duMONT Minute Man® and Hassay Savage are proud to be the largest suppliers of Push-type Broaches in America, offering parts to a wide variety of businesses through a vast national and international distribution network. Our record of design ingenuity, fast delivery and courteous follow-up is unsurpassed.



Materials

All duMONT Minute Man® and Hassay Savage Broaches are manufactured of the finest quality high speed steel. We are equipped to fabricate from a variety of grades to meet your specifications. Contact your industrial distributor or the duMONT Engineering Department for details.

Call Your Industrial Distributor

Your industrial distributor is your best source for duMONT Minute Man® and Hassay Savage Broaches. If your regular distributor does not carry our products, call us and we will be happy to give you the name of the nearest distributor. For special technical assistance, call our Engineering Department at 413-350-5200.

Fast Delivery

An order for stock items placed by your industrial distributor with us by 3:00 PM EST will almost always be shipped on the same working day.

Material Safety Data Sheet

Available upon request or at PilotPrecision.com.

General Ordering Information

When ordering stock Pilot Precision Products Tools from your distributor, please specify EDP No., size and description to ensure proper fulfillment.

Transportation

All shipments are made via UPS where weight limitations allow. Express shipments, both surface and air, are available at your request. Shipments are F.O.B. South Deerfield, MA, unless otherwise stated.

Prices

Please contact us for current pricing or refer to the current price list for prices on all stock items. Prices are subject to change without notice.

TiN or TiAlN Coating

All standard items are available with coatings from stock or short delivery. Please contact Pilot Precision Products for details.

Warning: *Cutting tools may shatter. Eye protection should be worn wherever and whenever cutting tools are being used.*

MADE in the USA



Keyway Broach Sets

1/16 thru 3/8 inch sizes



Applications: **Short Run Production | General Maintenance**

All of our Broach Sets are furnished in traditional boxes, either varnished wood or plastic, depending upon the set selected, and come complete with Precision Broaches, slotted Bushings and necessary Shims.

No. 00 Precision Set / No. 1				
3 Broaches and 5 Bushings = 15 Keyway combinations. Collared bushings only. Wt. 1 lbs				
Keyway Sizes (inch)	Broach Style	Bushings Diameters (bore sizes, inch)	EDP No.	
			duMONT	Hassay Savage
1/16, 3/32, 1/8	A / I	1/4, 5/16, 3/8, 7/16, 1/2	11101 Std 11301 TiN	*15315

Standard Set No. 30			
3 Broaches and 9 Bushings = 15 Keyway combinations. Collared bushings only. Wt. 8 lbs			
Keyway Sizes (inch)	Broach Style	Bushings Diameters (bore sizes, inch)	EDP No.
			duMONT
1/8	B / II	1/2, 5/8, 3/4	11112 Std
3/16, 1/4	C / III	7/8, 1, 1-1/8, 1-1/4, 1-3/8, 1-1/2	

Standard Set No. 10			
4 Broaches and 9 Bushings = 18 Keyway combinations. Collared bushings only. Wt. 10 lbs			
Keyway Sizes (inch)	Broach Style	Bushings Diameters (bore sizes, inch)	EDP No.
			duMONT
1/8, 3/16	B / II	1/2, 5/8, 3/4, 7/8	11104 Std
1/4, 3/8	C / III	1, 1-1/8, 1-1/4, 1-3/8, 1-1/2	11304 TiN

Standard Set No. C-10			
4 Broaches and 18 Bushings = 36 Keyway combinations. Collared bushings only. Wt. 13 lbs			
Keyway Sizes (inch)	Broach Style	Bushings Diameters (bore sizes, inch)	EDP No.
			Hassay Savage
1/8, 3/16	B / II	1/2, 9/16, 5/8, 11/16, 3/4, 13/16, 7/8	*15336
1/4, 3/8	C / III	15/16, 1, 1-1/16, 1-1/8, 1-3/16, 1-1/4, 1-5/16, 1-3/8, 1-7/16, 1-1/2, 1-9/16	

Standard Set No. 10A			
4 Broaches and 9 Bushings = 18 Keyway combinations. Collared bushings only. Wt. 10 lbs			
Keyway Sizes (inch)	Broach Style	Bushings Diameters (bore sizes, inch)	EDP No.
			duMONT
1/8, 3/16	B / II	9/16, 11/16, 13/16	11108 Std
1/4, 3/8	C / III	15/16, 1-1/16, 1-3/16 1-5/16, 1-7/16, 1-9/16	

Standard Set No. C-10A			
3 Broaches and 18 Bushings = 36 Keyway combinations. Collared bushings only. Wt. 13 lbs			
Keyway Sizes (inch)	Broach Style	Bushings Diameters (bore sizes, inch)	EDP No.
			Hassay Savage
1/8	B / II	1/2, 9/16, 5/8, 11/16, 3/4, 13/16, 7/8	*15330
3/16, 1/4	C / III	15/16, 1, 1-1/16, 1-1/8, 1-3/16, 1-1/4, 1-5/16, 1-3/8, 1-7/16, 1-1/2, 1-9/16	



*Kit comes in a Dura Case

All standard items are available with TiAlN coating from stock or short delivery. Please contact Pilot Precision Products for details.



Keyway Broach Sets

1/8 thru 3/8 inch sizes

Applications: **Short Run Production | General Maintenance**

All of our Broach Sets are furnished in traditional boxes, either varnished wood or plastic, depending upon the set selected, and come complete with Precision Broaches, slotted Bushings and necessary Shims.

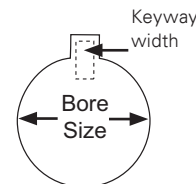

No. 10-10A Combination Set

4 Broaches and 18 Bushings = 36 Keyway combinations.
Collared bushings only. **Wt. 16 lbs**

Keyway Sizes (inch)	Broach Style	Bushing Diameters (bore sizes, inch)	EDP No. duMONT
1/8, 3/16	B / II	1/2, 9/16, 5/8, 11/16, 3/4, 13/16, 7/8	11120 Std
1/4, 3/8	C / III	15/16, 1, 1-1/16, 1-1/8, 1-3/16, 1-1/4, 1-5/16, 1-3/8, 1-7/16, 1-1/2, 1-9/16	

No. 20 Combination Set

5 Broaches and 18 Bushings = 47 Keyway combinations.
Collared bushings only. **Wt. 16 lbs**

Keyway Sizes (inch)	Broach Style	Bushing Diameters (bore sizes, inch)	EDP No. duMONT
1/8, 3/16	B / II	1/2, 9/16, 5/8, 11/16, 3/4, 13/16, 7/8	11121 Std 11321 TiN
1/4, 5/16, 3/8	C / III	15/16, 1, 1-1/16, 1-1/8, 1-3/16, 1-1/4, 1-5/16, 1-3/8, 1-7/16, 1-1/2, 1-9/16	

Standard Set C-1

4 Broaches and 9 Bushings = 18 Keyway combinations.
Collared bushings only. **Wt. 8 lbs**

Keyway Sizes (inch)	Broach Style	Bushing Diameters (bore sizes, inch)	EDP No. Hassay Savage
1/8, 3/16	B / II	1/2, 5/8, 3/4, 7/8	*15318
1/4, 3/8	C / III	1, 1-1/8, 1-1/4, 1-3/8, 1-1/2	



Keyway Broach Sets

1/8 thru 3/4 inch sizes



Applications: **Short Run Production | General Maintenance**

All of our Broach Sets are furnished in traditional boxes, either varnished wood or plastic, depending upon the set selected, and come complete with Precision Broaches, slotted Bushings and necessary Shims.

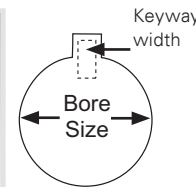

Standard Set No. 40A / 3-D

4 Broaches and 8 Bushings = 32 Keyway combinations.
Plain bushings only. **Wt. 50 lbs**

Keyway Sizes (inch)	Broach Style	Bushing Diameters (bore sizes, inch)	EDP No.	
			duMONT	Hassay Savage
5/16, 3/8, 7/16, 1/2	D / IV	1-1/2, 1-5/8, 1-3/4, 1-7/8, 2, 2-1/8, 2-1/4, 2-1/2	11127 Std	15024

Standard Set No. 40 / 3-DA

4 Broaches and 8 Bushings = 32 Keyway combinations.
Plain bushings only. **Wt. 50 lbs**

Keyway Size (inch)	Broach Style	Bushing Diameters (bore sizes, inch)	EDP No.	
			duMONT	Hassay Savage
5/16, 3/8, 7/16, 1/2	D / IV	1-7/16, 1-9/16, 1-11/16, 1-13/16, 1-15/16, 2-3/16, 2-7/16, 2-15/16	11129 Std	15124

Heavy Duty Set No. 40 1/2 A / 4-E

2 Broaches and 6 Bushings = 12 Keyway combinations.
Plain bushings only. **Wt. 74 lbs**

Keyway Sizes (inch)	Broach Style	Bushing Diameters (bore sizes, inch)	EDP No.	
			duMONT	Hassay Savage
5/8, 3/4	E / V	2-3/8, 2-1/2, 2-5/8, 2-3/4, 2-7/8, 3	11131 Std	

Heavy Duty Set No. 50 / No. 5

3 Broaches and 17 Bushings = 29 Keyway combinations.
Plain bushings only. **Wt. 175 lbs 3-4 Boxes**

Keyway Sizes (inch)	Broach Style	Bushing Diameters (bore sizes, inch)	EDP No.	
			duMONT	Hassay Savage
1/2	D / IV	2, 2-1/16, 2-1/8, 2-3/16, 2-1/4, 2-5/16, 2-3/8, 2-7/16	11135 Std	
5/8, 3/4	E / V	2-5/16, 2-3/8, 2-7/16, 2-1/2, 2-9/16, 2-5/8, 2-11/16, 2-3/4, 2-13/16, 2-7/8, 2-15/16, 3		

No. 100 Heavy Duty Combination Set

9 Broaches and 44 Bushings = 102 Keyway combinations.
Collared B / II and C / III bushings, plain D / IV and E / V bushing.
Wt. 250 lbs 5 Boxes

Keyway Sizes (inch)	Broach Style	Bushing Diameters (bore sizes, inch)	EDP No.	
			duMONT	Hassay Savage
1/8, 3/16	B / II	1/2, 9/16, 5/8, 11/16, 3/4, 13/16, 7/8	11136 Std	
1/4, 5/16	C / III	15/16, 1, 1-1/16, 1-1/8, 1-3/16, 1-1/4, 1-5/16, 1-3/8, 1-7/16, 1-1/2, 1-9/16		
3/8, 7/16, 1/2	D / IV	1-7/16, 1-1/2, 1-9/16, 1-5/8, 1-11/16, 1-3/4, 1-13/16, 1-7/8, 1-15/16, 2, 2-1/16, 2-1/8, 2-3/16, 2-1/4		
5/8, 3/4	E / V	2-5/16, 2-3/8, 2-7/16, 2-1/2, 2-9/16, 2-5/8, 2-11/16, 2-3/4, 2-13/16, 2-7/8, 2-15/16, 3		

*NOTE: Shipped via freight truck only.



Metric Keyway Broach Sets

2mm thru 18mm



Applications: **Short Run Production** | **General Maintenance**

All of our Broach Sets are furnished in traditional boxes, either varnished wood or plastic, depending upon the set selected, and come complete with Precision Broaches, slotted Bushings and necessary Shims.

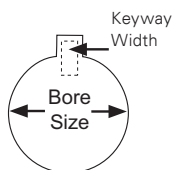

No. 40 Metric Set			
6 Broaches and 18 Bushings = 36 Keyway Combinations Collared Bushings Only. Wt. 10 lbs			
Keyway Sizes (mm)	Broach Style	Bushing Diameters (bore sizes, mm)	EDP No. Hassay Savage
2 3	A / I	8, 10	*15440
4 5	B / II	12, 14, 16, 18	
6 8	C / III	18, 19, 20, 22, 24, 25, 26, 28, 30, 32, 34	

No. 90 Metric Set			
2 Broaches and 8 Bushings = 16 Keyway combinations. Plain bushings only. Wt. 61 lbs			
Keyway Sizes (mm)	Broach Style	Bushing Diameters (bore sizes, mm)	EDP No. duMONT
16 18	E / V	52, 54, 55, 56 58, 60, 62, 65	44500 Std

No. 60 Metric Set			
2 Broaches and 3 Bushings = 6 Keyway combinations. Collared bushings only. Wt. 1 lbs			
Keyway Sizes (mm)	Broach Style	Bushing Diameters (bore sizes, mm)	EDP No. duMONT
2 3	A / I	6, 8, 10	44497 Std

Precision Set 10			
2 Broaches and 5 Bushings = 10 Keyway combinations. Collared bushings only. Wt. 1 lbs			
Keyway Sizes (mm)	Broach Style	Bushing Diameters (bore sizes, mm)	EDP No. Hassay Savage
2 3	A / I	6, 7, 8, 9, 10	*15410

No. 70 Metric Set			
4 Broaches and 13 Bushings = 26 Keyway combinations. Collared bushings only. Wt. 15 lbs			
Keyway Sizes (mm)	Broach Style	Bushing Diameters (bore sizes, mm)	EDP No. duMONT
4 5	B / II	12, 14 15, 16	44498 Std
6 8	C / III	18, 19, 20, 22 24, 25, 26, 28, 30	

Metric Set 12			
2 Broaches and 6 Bushings = 12 Keyway combinations. Plain bushings only. Wt. 70 lbs			
Keyway Sizes (mm)	Broach Style	Bushing Diameters (bore sizes, mm)	EDP No. Hassay Savage
16 18	E / V	54, 56, 58, 60, 62, 64	15212

No. 80 Metric Set			
3 Broaches and 12 Bushings = 36 Keyway combinations. Plain bushings only. Wt. 40 lbs			
Keyway Sizes (mm)	Broach Style	Bushing Diameters (bore sizes, mm)	EDP No. duMONT
10 12 14	D / IV	32, 34, 35, 36 38, 40, 42, 44 45, 46, 48, 50	44499 Std

Metric Set 18			
4 Broaches and 9 Bushings = 18 Keyway combinations. Collared bushings only. Wt. 7 lbs			
Keyway Sizes (mm)	Broach Style	Bushing Diameters (bore sizes, mm)	EDP No. Hassay Savage
4 5 6 8	B / II C / III	12, 14, 16, 18 20, 22, 24, 26, 28	*15418

Metric Set 24			
3 Broaches and 8 Bushings = 24 Keyway combinations. Plain bushings only. Wt. 36 lbs			
Keyway Sizes (mm)	Broach Style	Bushing Diameters (bore sizes, mm)	EDP No. Hassay Savage
10 12 14	D / IV	34, 36, 38, 40, 42, 44, 46, 48	15224

*Kit comes in a Dura Case

All standard items are available with TiAIN coating from stock or short delivery. Please contact Pilot Precision Products for details.



A/I - Imperial - Keyway

1/16 thru 1/8 inch sizes



Applications: **Short Run Production | General Maintenance**

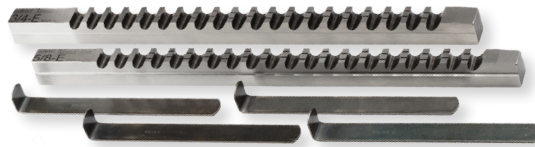

Stock Keyway Broaches

Broaches are supplied with necessary Shims unless otherwise noted. For extra or replacement Shims see the table below.

Broach Size (inch)	Tolerances	Broach Dimensions	Shims Required	Length of Cut		Pressure Required. for Max. L/C (lbs.)	EDP No.			
				Min.	Max.		duMONT Std	duMONT TiN	duMONT TiAIN	Hassay Savage
1/16-A	.0625 - .0635	1/8 x 5	0	13/64	1-1/8	390	22201	22301	22801	10104
3/32-A	.0938 - .0948	1/8 x 5	0	13/64	1-1/8	780	22202	22302	22802	10106
1/8-A	.1252 - .1262	1/8 x 5	1	13/64	1-1/8	650	22203	22303	22803	10108

A / I Bushings for A / I Broaches (collared only)

Diameter (inch)	Length	EDP No.	
		duMONT	Hassay Savage
1/4	1-1/8	33301	20116
5/16		33302	20120
3/8		33303	20124
7/16		33304	20128
1/2		33305	20132

Extra Shims

Please specify EDP No. when ordering extra or replacement Shims. Shims correspond to Broach size, not to Bushing type.

Broach Size (inch)	# / Set	Shim Thickness	EDP No.
1/8-A	1	.031	22250

B/II - Imperial - Keyway

3/32 thru 3/16 inch sizes



Stock Keyway Broaches

Broaches are supplied with necessary Shims unless otherwise noted. For extra or replacement Shims see the table below.

Broach Size (inch)	Tolerances	Broach Dimensions	Shims Required	Length of Cut		Pressure Required. for Max. L/C (lbs.)	EDP No.			
				Min.	Max.		duMONT Std	duMONT TiN	duMONT TiAIN	Hassay Savage
3/32-B	.0938 - .0948	3/16 x 6-3/4	0	19/64	1-11/16	930	22204	22304	22804	10206
1/8-B	.1252 - .1262	3/16 x 6-3/4	1	19/64	1-11/16	720	22205	22305	22805	10208
5/32-B	.1564 - .1574	3/16 x 6-3/4	1	19/64	1-11/16	1,320	22206	22306	22806	10210
3/16-B	.1877 - .1887	3/16 x 6-3/4	1	19/64	1-11/16	1,860	22207	22307	22807	10212

B / II Bushings for B / II Broaches (collared only)

Diameter (inch)	Length	EDP No.	
		duMONT	Hassay Savage
1/2	1-11/16	33313	20232
9/16		33314	20236
5/8		33315	20240
11/16		33316	20244
3/4		33317	20248
13/16		33318	20252
7/8		33319	20256

Extra Shims

Please specify EDP No. when ordering extra or replacement Shims. Shims correspond to Broach size, not to Bushing type.

Broach Size (inch)	# / Set	Shim Thickness	EDP No.
1/8-B	1	.031	22252
5/32-B	1	.042	22253
3/16-B	1	.050	22254

SPECIAL ORDERS: We are fully equipped to manufacture Special Bushings not listed. Please contact Pilot Precision Products for details.



C/III - Imperial - Keyway

3/16 thru 3/8 inch sizes



Stock Keyway Broaches

Broaches are supplied with necessary Shims unless otherwise noted. For extra or replacement Shims see the table below.

Broach Size (inch)	Tolerances	Broach Dimensions	Shims Required	Length of Cut		Pressure Required. for Max. L/C (lbs.)	EDP No.			
				Min.	Max.		duMONT Std	duMONT TiN	duMONT TiAIN	Hassay Savage
3/16-C	.1877 - .1887	3/8 x 11-3/4	1	25/64	2-1/2	1,540	22208	22308	22808	10312
1/4-C	.2502 - .2512	3/8 x 11-3/4	1	25/64	2-1/2	2,520	22209	22309	22809	10316
5/16-C	.3127 - .3137	3/8 x 11-3/4	2	25/64	2-1/2	3,960	22210	22310	22810	10320
3/8-C	.3755 - .3765	3/8 x 11-3/4	2	25/64	2-1/2	4,340	22211	22311	22811	10324

C / III Bushings for C / III Broaches (collared only)

Diameter (inch)	Length	EDP No.	
		duMONT	Hassay Savage
3/4	2-1/2	33334	20348
13/16		33335	20352
7/8		33336	20356
15/16		33337	20360
1		33338	20364
1-1/16		33339	20368
1-1/8		33340	20372
1-3/16		33341	20376
1-1/4		33342	20380
1-5/16		33343	20384
1-3/8		33344	20388
1-7/16		33345	20392
1-1/2		33346	20396
1-9/16		33347	20400

Extra Shims

Please specify EDP No. when ordering extra or replacement Shims. Shims correspond to Broach size, not to Bushing type.

Broach Size (inch)	# / Set	Shim Thickness	EDP No.
3/16-C	1	.050	22255
1/4-C	1	.0625	22256
5/16-C	2	.055	22257
3/8-C	2	.0625	22258

D/IV - Imperial - Keyway

5/16 thru 9/16 inch sizes



Stock Keyway Broaches

Broaches are supplied with necessary Shims unless otherwise noted. For extra or replacement Shims see the table below.

Broach Size (inch)	Tolerances	Broach Dimensions	Shims Required	Length of Cut		Pressure Required. for Max. L/C (lbs.)	EDP No.			
				Min.	Max.		duMONT Std	duMONT TiN	duMONT TiAIN	Hassay Savage
5/16-D	.3127 - .3137	9/16 x 13-7/8	2	1	6	8,000	22212	22312	22812	10420
3/8-D	.3755 - .3765	9/16 x 13-7/8	2	1	6	7,000	22213	22313	22813	10424
7/16-D	.4380 - .4390	9/16 x 13-7/8	3	1	6	9,400	22214	22314	22814	10428
1/2-D	.5006 - .5016	9/16 x 13-7/8	3	1	6	9,800	22215	22315	22815	10432
9/16-D	.5631 - .5641	9/16 x 13-7/8	4	1	6	8,900	10142	10342	10842	10436

D / IV Bushings for D / IV Broaches (plain only)

Diameter (inch)	Length	EDP No.	
		duMONT	Hassay Savage
1-7/16	4	33348	21492
1-1/2		33349	21496
1-9/16		33350	21500
1-5/8		33351	21504
1-11/16		33352	21508
1-3/4		33353	21512

D / IV Bushings for D / IV Broaches (plain only)

Diameter (inch)	Length	EDP No.	
		duMONT	Hassay Savage
1-13/16	5	33354	21516
1-7/8		33355	21520
1-15/16		33356	21524
2		33357	21528
2-1/16		33358	21532
2-1/8		33359	21536
2-3/16		33360	21540
2-1/4		33361	21544
2-5/16	33362	21548	

D / IV Bushings for D / IV Broaches (plain only)

Diameter (inch)	Length	EDP No.	
		duMONT	Hassay Savage
2-3/8	6	33363	21552
2-7/16		33364	21556
2-1/2		33365	21560
2-9/16		33366	21564
2-5/8		33367	21568
2-11/16		33368	21572
2-3/4		33369	21576
2-13/16		33370	21580
2-7/8		33371	21584
2-15/16		33372	21588
3		33373	21592

Extra Shims

Please specify EDP No. when ordering extra or replacement Shims. Shims correspond to Broach size, not to Bushing type.

Broach Size (inch)	# / Set	Shim Thickness	EDP No.
5/16-D	2	.056	22259
3/8-D	2	.0625	22260
7/16-D	3	.056	22261
1/2-D	3	.0625	22262
9/16-D	4	.056	22269

E/V - Imperial - Keyway

5/8 thru 3/4 inch sizes

Stock Keyway Broaches

Broaches are supplied with necessary Shims unless otherwise noted. For extra or replacement Shims see the table below.

Broach Size (inch)	Tolerances	Broach Dimensions	Shims Required	Length of Cut		Pressure Required for Max. L/C (lbs.)	EDP No.			
				Min.	Max.		duMONT Std	duMONT TiN	duMONT TiAlN	Hassay Savage
5/8-E	.6260 - .6270	3/4 x 15-1/2	4	1	6	9,600	22216	22316	22816	10540
3/4-E	.7515 - .7525	3/4 x 15-1/2	5	1	6	11,900	22217	22317	22817	10548

E / V Bushings for E / V Broaches (plain only)

Diameter (inch)	Length	EDP No.	
		duMONT	Hassay Savage
2-5/16	6	33374	21688
2-3/8		33375	21692
2-7/16		33376	21696
2-1/2		33377	21700
2-9/16		33378	21704
2-5/8		33379	21708
2-11/16		33380	21712
2-3/4		33381	21716
2-13/16		33382	21720
2-7/8		33383	21724
2-15/16		33384	21728

E / V Bushings for E / V Broaches (plain only)

Diameter (inch)	Length	EDP No.	
		duMONT	Hassay Savage
3	6	33385	21732
3-1/16		33386	-
3-1/8		33387	-
3-3/16		33388	-
3-1/4		33389	-
3-5/16		33390	-
3-3/8		33391	-
3-7/16		33392	-
3-1/2		33393	-
3-9/16		33394	-
3-5/8		33395	-
3-11/16		33396	-
3-3/4		33397	-
3-13/16		33398	-
3-7/8		33399	-
3-15/16		33400	-
4		33401	-

Extra Shims

Please specify EDP No. when ordering extra or replacement Shims. Shims correspond to Broach size, not to Bushing type.

Broach Size (inch)	# / Set	Shim Thickness	EDP No.
5/8-E	4	.0625	22263
3/4-E	5	.0625	22264

F/VI - Imperial - Keyway

5/16 thru 9/16 inch sizes

Stock Keyway Broaches

Broaches are supplied with necessary Shims unless otherwise noted. For extra or replacement Shims see the table below.

Broach Size (inch)	Tolerances	Broach Dimensions	Shims Required	Length of Cut		Pressure Required for Max. L/C (lbs.)	EDP No.			
				Min.	Max.		duMONT Std	duMONT TiN	duMONT TiAlN	Hassay Savage
7/8-F	.8765 - .8775	1 x 19-3/4	6	1	6	9,800	22218	22318	22818	10656
1-F	1.0015 - 1.0025	1 x 19-3/4	7	1	6	11,100	22219	22319	22819	10664

F / VI Bushings for F / VI Broaches (plain only)

Diameter (inch)	Length	EDP No.
		duMONT
3-1/16	6	33500
3-1/8		33501
3-3/16		33502
3-1/4		33503
3-5/16		33504
3-3/8		33505
3-7/16		33506
3-1/2		33507
3-9/16		33508
3-5/8		33509

F / VI Bushings for F / VI Broaches (plain only)

Diameter (inch)	Length	EDP No.
		duMONT
3-11/16	6	33510
3-3/4		33511
3-13/16		33512
3-7/8		33513
3-15/16		33514
4		33515
4-1/16		33516
4-1/8		33517
4-3/16		33518
4-1/4		33519

F / VI Bushings for F / VI Broaches (plain only)

Diameter (inch)	Length	EDP No.
		duMONT
4-5/16	6	33520
4-3/8		33521
4-7/16		33522
4-1/2		33523
4-9/16		33524
4-5/8		33525
4-11/16		33526
4-3/4		33527
4-13/16		33528
4-7/8		33529
4-15/16		33530
5		33531

Extra Shims

Please specify EDP No. when ordering extra or replacement Shims. Shims correspond to Broach size, not to Bushing type.

Broach Size (inch)	# / Set	Shim Thickness	EDP No.
7/8-F	6	.0625	22265
1-F	7	.0625	22266

A/I - Metric - Keyway

2 thru 3 mm sizes



Applications: **Short Run Production | General Maintenance**

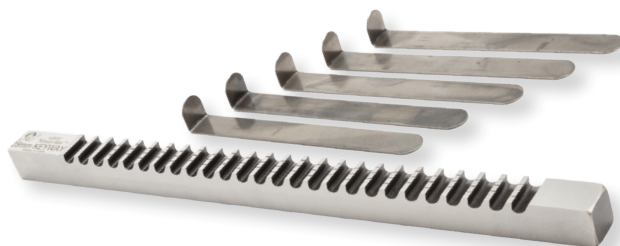

Stock Keyway Broaches / Optional Metric Keyway Broaches

Broaches are supplied with necessary Shims unless otherwise noted. For extra or replacement Shims see the table below.

Broach Size (mm)	Tolerances (Decimal Equiv.)	Broach Dimensions (inches)	Standard Millimeter Keys	Shims Req'd	Length of Cut (inches)		Pressure Required. for Max. L/C (lbs.)*	EDP No.			
					Min.	Max.		duMONT Std.	duMONT TiN	duMONT TiAIN	Hassay Savage
2-A / I	0.0782 – 0.0791	1/8 x 5	2 x 2	0	13/64	1-1/8	720	44401	44301	44801	11102
3-A / I	0.1176 – 0.1185		3 x 3	1			650	44402	44302	44802	11103

A / I Bushings for A / I Broaches *(collared only)*

Diameter (mm)	(Decimal Equiv.)	EDP No.	
		duMONT	Hassay Savage
6	.2362	44501	22106
7	.2756	-	22107
8	.3150	44431	22108
9	.3543	-	22109
10	.3937	44432	22110
12	.4724	44502	
15	.5905	44503	

Extra Shims

Please specify EDP No. when ordering extra or replacement Shims. Shims correspond to Broach size, not to Bushing type.

Broach Size (mm)	# / Set	Shim Thickness	EDP No. duMONT
3-A / I	1	0.0310	44480

B1/II - Metric - Keyway

4 thru 5 mm sizes



Stock Keyway Broaches / Optional Metric Keyway Broaches

Broaches are supplied with necessary Shims unless otherwise noted. For extra or replacement Shims see the table below.

Broach Size (mm)	Tolerances (Decimal Equiv.)	Broach Dimensions (inches)	Standard Millimeter Keys	Shims Req'd	Length of Cut (inches)		Pressure Required. for Max. L/C (lbs.)*	EDP No.			
					Min.	Max.		duMONT Std.	duMONT TiN	duMONT TiAIN	Hassay Savage
4-B1 / II	0.1569 – 0.1579	1/4 x 6-3/4	4 x 4	1	19/64	1-11/16	1,140	44403	44303	44803	11204
5-B1 / II	0.1963 – 0.1972		5 x 5				1,860	44404	44304	44804	11205

B1 / II Bushings for B1 / II Broaches *(collared only)*

Diameter (mm)	(Decimal Equiv.)	EDP No.	
		duMONT	Hassay Savage
11	.4331	44510	22211HS
12	.4724	44433	22212HS
13	.5118	44511	22213HS
14	.5512	44434	22214HS
15	.5905	44504	22215HS
16	.6299	44435	22216HS
17	.6693	44505	22217HS
18	.7087	44436	22218HS
19	.7480	44506	22219HS

Extra Shims

Please specify EDP No. when ordering extra or replacement Shims. Shims correspond to Broach size, not to Bushing type.

Broach Size (mm)	# / Set	Shim Thickness	EDP No. duMONT
4-B1 / II	1	0.0380	44481
5-B1 / II		0.0500	44482



C/III - Metric - Keyway

5 thru 8 mm sizes



Stock Keyway Broaches / Optional Metric Keyway Broaches

Broaches are supplied with necessary Shims unless otherwise noted. For extra or replacement Shims see the table below.

Broach Size (mm)	Tolerances (Decimal Equiv.)	Broach Dimensions (inches)	Standard Millimeter Keys	Shims Req'd	Length of Cut (inches)		Pressure Required for Max. L/C (lbs.)*	EDP No.			
					Min.	Max.		duMONT Std.	duMONT TiN	duMONT TiAIN	Hassay Savage
5-C / III	0.1963 – 0.1972	3/8 x 11-3/4	5 x 5	1	25/64	2-1/2	1,470	44405	44305	44805	11305
6-C / III	0.2356 – 0.2366		6 x 6	1			2,100	44406	44306	44806	11306
7-C / III	0.2749 – 0.2763		7 x 6	1			2,900	10232	10332	10832	11307
8-C / III	0.3143 – 0.3155		8 x 7	2			3,680	44407	44307	44807	11308HS

C / III Bushings for C / III Broaches (collared only)

Diameter (mm)	(Decimal Equiv.)	EDP No.	
		duMONT	Hassay Savage
17	.6693	44512	22317HS
18	.7087	44437	22318HS
19	.7480	44438	22319HS
20	.7874	44439	22320HS
22	.8661	44440	22322HS
24	.9449	44441	22324HS
25	.9842	44442	22325HS
26	1.0236	44443	22326HS
27	1.0630	-	22327HS
28	1.1024	44444	22328HS
30	1.1811	44445	22330HS
32	1.2598	44446	22332HS
34	1.3386	44447	22334HS
35	1.3779	44507	22335HS
36	1.4173	44448	22336HS

Extra Shims

Please specify EDP No. when ordering extra or replacement Shims. Shims correspond to Broach size, not to Bushing type.

Broach Size (mm)	# / Set	Shim Thickness	EDP No. duMONT
5-C / III	1	0.0470	44483
6-C / III	1	0.0625	44484
7-C / III	1	0.0625	44577
8-C / III	2	0.0500	44485

D/IV - Metric - Keyway

10 thru 14 mm sizes



Stock Keyway Broaches / Optional Metric Keyway Broaches

Broaches are supplied with necessary Shims unless otherwise noted. For extra or replacement Shims see the table below.

Broach Size (mm)	Tolerances (Decimal Equiv.)	Broach Dimensions (inches)	Standard Millimeter Keys	Shims Req'd	Length of Cut (inches)		Pressure Required for Max. L/C (lbs.)*	EDP No.			
					Min.	Max.		duMONT Std.	duMONT TiN	duMONT TiAIN	Hassay Savage
10-D / IV	0.3930 – 0.3942	9/16 x 13-7/8	10 x 8	2	1	6	6,500	44408	44308	44808	11410
12-D / IV	0.4716 – 0.4730		12 x 8				8,400	44409	44309	44809	11412
14-D / IV	0.5503 – 0.5517		14 x 9				11,100	44410	44310	44810	11414

D / IV Bushings for D / IV Broaches (plain only)

Diameter (mm)	(Decimal Equiv.)	EDP	
		duMONT	Hassay Savage
32	1.2598	44449	22432
34	1.3386	44450	22434
35	1.3779	44451	22435
36	1.4173	44452	22436
38	1.4961	44453	22438
40	1.5748	44454	22440
42	1.6535	44455	22442
44	1.7323	44456	22444

D / IV Bushings for D / IV Broaches (plain only)

Diameter (mm)	(Decimal Equiv.)	EDP	
		duMONT	Hassay Savage
45	1.7716	44457	22445
46	1.8110	44458	22446
48	1.8898	44459	22448
50	1.9685	44460	22450
52	2.0472	44461	22452
54	2.1260	44462	22454
55	2.1653	-	22455
56	2.2047	44463	22456

Extra Shims

Please specify EDP No. when ordering extra or replacement Shims. Shims correspond to Broach size, not to Bushing type.

Broach Size (mm)	# / Set	Shim Thickness	EDP No. duMONT
10-D / IV	2	0.0560	44486
12-D / IV		0.0560	44487
14-D / IV		0.0625	44488

E/V - Metric - Keyway

16 thru 18 mm sizes



Stock Keyway Broaches / Optional Metric Keyway Broaches

Broaches are supplied with necessary Shims unless otherwise noted. For extra or replacement Shims see the table below.

Broach Size (mm)	Tolerances (Decimal Equiv.)	Broach Dimensions (inches)	Standard Millimeter Keys	Shims Req'd	Length of Cut (inches)		Pressure Required. for Max. L/C (lbs.)*	EDP No.			
					Min.	Max.		duMONT Std.	duMONT TiN	duMONT TiAIN	Hassay Savage
16-E / V	0.6290 – 0.6304	3/4 x 15-1/2	16 x 10	3	1	6	9,400	44411	44311	44811	11516
18-E / V	0.7078 – 0.7092		18 x 11					10,600	44412	44312	44812

E / V Bushings for E / V Broaches (plain only)

Diameter (mm)	(Decimal Equiv.)	EDP No.	
		duMONT	Hassay Savage
52	2.0472	44464	22552
54	2.1260	44465	22554
55	2.1653	44466	22555
56	2.2047	44467	22556
58	2.2835	44468	22558
60	2.3622	44469	22560
62	2.4409	44470	22562
63	2.4803	44471	-
64	2.5197	44472	22564
65	2.5590	44473	22565
66	2.5984	44474	22566
68	2.6772	44475	22568
70	2.7559	44476	22570
72	2.8346	44477	22572

Extra Shims

Please specify EDP No. when ordering extra or replacement Shims. Shims correspond to Broach size, not to Bushing type.

Broach Size (mm)	# / Set	Shim Thickness	EDP No. duMONT
16-E / V	3	0.0560	44489
18-E / V		0.0560	44490

F/VI - Metric - Keyway

16 thru 18 mm sizes



Stock Keyway Broaches / Optional Metric Keyway Broaches

Broaches are supplied with necessary Shims unless otherwise noted. For extra or replacement Shims see the table below.

Broach Size (mm)	Tolerances (Decimal Equiv.)	Broach Dimensions (inches)	Standard Millimeter Keys	Shims Req'd	Length of Cut (inches)		Pressure Required. for Max. L/C (lbs.)*	EDP No.				
					Min.	Max.		duMONT Std.	duMONT TiN	duMONT TiAIN	Hassay Savage	
20-F / VI	0.7864 – 0.7880	1 x 19-3/4	20 x 12	3	1	6	8,800	44413	44313	44813	11620	
22-F / VI	0.8651 – 0.8667		22 x 14	4				9,400	44414	44314	44814	11622
24-F / VI	0.9439 – 0.9455		24 x 14	4				10,600	44415	44315	44815	11624
25-F / VI	0.9832 – 0.9848		25 x 14	4				12,300	44494	44394	44894	11625

F / VI Bushings for F / VI Broaches (plain only)

Diameter (mm)	(Decimal Equiv.)	EDP No. duMONT
70	2.7559	44539
75	2.9527	44540
80	3.1496	44541
85	3.3464	44542
90	3.5433	44543
95	3.7401	44544
100	3.9370	44545
105	4.1338	44546
110	4.3307	44547
115	4.5275	44548
120	4.7244	44549

Extra Shims

Please specify EDP No. when ordering extra or replacement Shims. Shims correspond to Broach size, not to Bushing type.

Broach Size (mm)	# / Set	Shim Thickness	EDP No. duMONT
20-F	3	0.0625	44491
22-F	4	0.0560	44492
24-F	5	0.0625	44493
25-F	4	0.0560	44496



Additional Sizes - Imperial - Keyway

1-1/8 thru 2 inch sizes

Stock Keyway Broaches

Broaches are supplied with necessary Shims unless otherwise noted. For extra or replacement Shims see the table below.

Broach Size (inch)	Tolerances	Broach Dimensions	Shims Required	Length of Cut		Pressure Required. for Max. L/C (lbs.)	EDP No.			
				Min.	Max.		duMONT Std	duMONT TiN	duMONT TiAIN	Hassay Savage
1-1/8	1.1265 – 1.1275	1-1/8 x 20-1/4	8	1	6	14,750	10171	-	-	10666HS
1-1/4	1.2520 – 1.2530	1-1/4 x 20-1/4	9	1-1/2	8	22,100	10172	-	-	10668HS
1-3/8	1.3770 – 1.3780	1-3/8 x 20-1/4	**	1-1/2	8	23,500	10173	-	-	10670HS
1-1/2	1.5020 – 1.5030	1-1/2 x 20-1/4	**	1-1/2	8	26,500	10174	-	-	10672HS
1-3/4	1.7520 – 1.7530	1-3/4 x 20-1/4	**	1-1/2	8	31,400	10175	-	-	-
2	2.003 – 2.004	1-3/4 x 20-1/16	**	1-1/2	8	35,900	10176	-	-	-

*Based on mild steel **Shims are not supplied with these broaches, sold as Progressive Shims only, see below

■ 1-1/8" to 2" broaches need special order bushings. Please provide bore diameter to quote.

Extra Shims

Extra Shims are provided in necessary Shim Sets only. For Broaches larger than 1-1/4" progressive Shims are available as special items. Please specify EDP No. when ordering extra or replacement Shims. Shims correspond to Broach size, not to Bushing type.

Broach Size (inch)	# / Set	Shim Thickness	EDP No.
1-1/8	8	.0625	22267
1-1/4	9	.0625	22268

Progressive Shims

Broach Size (inch)	# / Set	Shim Thickness				EDP No.
1-3/8	4	.062, .125, .250, .375				22270
1-1/2	4	.062, .125, .250, .375				22271
1-3/4	4	.062, .125, .250, .375				22272
2	5	.062, .125, .250, .375, .500				22273

All standard items are available with TiAIN coating from stock or short delivery. Please contact Pilot Precision Products for details.

Additional Sizes - Metric - Keyway

28 thru 45mm sizes

Stock Keyway Broaches / Optional Metric Keyway Broaches

Broaches are supplied with necessary Shims unless otherwise noted. For extra or replacement Shims see the table below.

Broach Size (mm)	Tolerances (Decimal Equiv.)	Broach Dimensions (inches)	Standard Millimeter Keys	Shims Req'd	Length of Cut (inches)		Pressure Required. for Max. L/C (lbs.)*	EDP No			
					Min.	Max.		duMONT Std.	duMONT TiN	duMONT TiAIN	Hassay Savage
28	1.1025 – 1.1035	1-1/8 x 20-1/4	28 x 16	5	1	6	12,000	10233	-	-	11628
32	1.2600 – 1.2610	1-1/4 x 20-1/4	32 x 18	5	1-1/2	8	20,600	10234	-	-	11632
36	1.4175 – 1.4185	1-7/16 x 20-1/4	36 x 20	**	1-1/2	8	24,200	10235	-	-	11636
40	1.5753 – 1.5760	1-9/16 x 20-1/4	40 x 22	**	1-1/2	8	22,500	10236	-	-	-
45	1.7718 – 1.7728	1-3/4 x 20-1/4	45 x 25	**	1-1/2	8	27,200	10237	-	-	-

*Based on mild steel **Shims are not supplied with these broaches, sold as Progressive Shims only, see below

Extra Shims

Extra Shims are provided in necessary Shim Sets only. Shims are available as special items for Broaches larger than 32mm progressive. Please specify EDP No. when ordering extra or replacement Shims. Shims correspond to Broach size, not to Bushing type.

Broach Size (mm)	# / Set	Shim Thickness	EDP No. duMONT
28	5	0.0560	44478
32		0.0625	44479

■ 1-1/8" to 2" & 28 mm to 45 mm broaches need special order bushings. Please provide bore diameter to quote.



Progressive Shims

Broach Size (mm)	# / Set	Shim Thickness	EDP No. duMONT
36	3	.062, .125, .250	44578
40	3	.062, .125, .250	44579
45	4	.062 (2pcs), .125, .250	44580

SPECIAL ORDERS: We are fully equipped to manufacture Special Bushings not listed above. Please contact Pilot Precision Products for details.

One-Pass Keyway Broaches

1/8 thru 3/8 inch sizes

3mm thru 14mm

Applications: High Speed Operation | Accurate Small Run Production

One-Pass Keyway Broaches are designed for smaller production runs of identical keyways in varying bores. Used with the appropriate Bushing size (American Standard or Metric) and Style (see pages 10 and 12) to cut to full width and depth in one-pass, no shimming required. Reminder – Broach and Bushing Style must match – “A / I” Broaches with “A / I” Bushings, “B / II” Broaches with “B / II” Bushings, etc. A special chamfering feature that will deburr the keyway while it is being broached is also available.

TiN or TiAlN coatings available.



Stock One-Pass Broaches – Inch							
Broach Size (inch)	Broach Dimensions	Tolerances (Decimal Equiv.)	Tooth Pitch	Length of Cut* (inches)		Pressure Required. for Max. L/C (lbs.)*	EDP No. duMONT
				Min.	Max.		
1/8-B / II	3/16 x 10-3/4	.1252 – .1262	1/4	19/64	1-11/16	800	55507
5/32-B / II	3/16 x 10-3/4	.1564 – .1574				1,450	55508
3/16-B / II	3/16 x 10-3/4	.1877 – .1887				2,050	55509
1/8-C / III	3/8 x 14-1/8	.1252 – .1262	9/32	19/64	2	900	55501
5/32-C / III	3/8 x 14-1/8	.1564 – .1574				1,360	55502
3/16-C / III	3/8 x 17	.1877 – .1887				1,570	55503
1/4-C / III	3/8 x 17	.2502 – .2512				2,560	55504
5/16-C / III	3/8 x 18-1/2	.3127 – .3137				3,900	55505
3/8-C / III	3/8 x 18-1/2	.3755 – .3765				5,300	55506

Stock One-Pass Metric Keyway Broaches								
Broach Size (mm)	Broach Dimensions	Tolerances (Decimal Equiv.)	Tooth Pitch	Length of Cut* (inches)		Pressure Required. for Max. L/C (lbs.)*	EDP No.	
				Min.	Max.		duMONT	Hassay Savage
3-A / I	1/8 x 7-3/4	0.1176 – 0.1185	3/16	13/64	1	675	55510	11103-OP**
4-B1 / II	1/4 x 10-3/4	0.1569 – 0.1579	1/4	3/8	1-5/8	1,550	55511	11204-COP***
5-B1 / II		0.1963 – 0.1972				2,430	55512	11205-COP***
6-C / III	3/8 x 17	0.2356 – 0.2366	9/32	3/8	1-3/4	2,240	55513	11306-COP***
8-C / III	3/8 x 18-1/2	0.3143 – 0.3155	5/16			2	3,485	55514
10-D / IV	9/16 x 24	0.3930 – 0.3942	3/8	25/64	2	3,410	55515	-
12-D / IV		0.4716 – 0.4730				4,220	55516	-
14-D / IV		0.5503 – 0.5517				5,670	55517	-

*Based on mild steel

OP** designates one-pass, no chamfer

COP*** designates chamfer one pass

Note: 4mm—12mm keyway broaches have deburring feature

All standard items are available with TiN or TiAlN coating from stock or short delivery. Please contact Pilot Precision Products for details.

SPECIAL ORDERS: We are fully equipped to manufacture Special One-Pass Broaches to your specifications. A special chamfering feature that will deburr the keyway while it is being broached is also available. TiN or TiAlN coatings are available. Please contact Pilot Precision Products for details.



Production Push-type Keyway Broaches

Applications: **High Speed Operation | Accurate Long Run Production**



Production Keyway Broaches

Production Keyway Broaches offer maximum speed and accuracy in production runs of identical bores, using either hydraulic or hand-operated presses. These Broaches are self-supporting—no Shims or Bushings are required.

Production Broach Construction

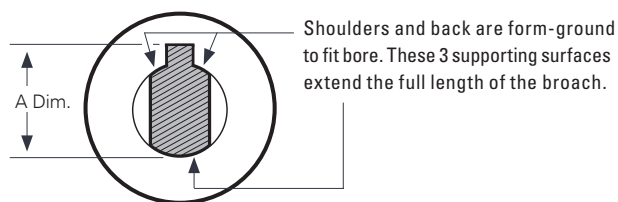

Stock Production Keyway Broaches

Production Keyway Broaches are designed for large production runs of identical keyways with identical bores. No Shims or Bushings required. A special chamfering feature that will deburr the keyway while it is being broached is also available. **TiN or TiAlN coatings available.**

Keyway Width	Body Diameter	A Dimension	Broach Length	Tooth Pitch	Length of Cut*		Pressure Required. for Max. L/C (lbs.)	EDP No. duMONT
					Min.	Max.		
1/16"	3/16"	.224"	5-5/8	3/16	13/64	1	390	55520
	1/4"	.287"	6-3/16	3/16	13/64	1	390	55521
1/8"	3/8"	.437"	8-1/2	1/4	17/64	1-1/4	850	55522
	1/2"	.565"	11-3/4	3/8	25/64	2-1/2	1,440	55523
	9/16"	.630"	11-3/4	3/8	25/64	2-1/2	1,440	55524
3/16"	5/8"	.693"	11-3/4	3/8	25/64	2-1/2	1,440	55525
	3/4"	.716"	14-3/4	3/8	25/64	2-1/2	2,170	55526
	7/8"	.844"		3/8	25/64	2-1/2	2,170	55528
1/4"	1"	.970"		3/8	25/64	2-1/2	2,870	55532
4mm	10mm	1.121"	18	9/32	19/64	1-7/8	1,550	55533**
		.468"						

*Based on mild steel

** Includes Chamfer

All standard items are available with TiN or TiAlN coating from stock or short delivery. Please contact Pilot Precision Products for details.

SPECIAL ORDERS: We are fully equipped to manufacture Special Production Style Broaches to your specifications. A special chamfering feature that will deburr the keyway while it is being broached is also available. Please contact Pilot Precision Products for details.

Square Push Broaches

1/8 thru 1 inch sizes

4mm thru 25mm sizes



Applications: **Drives, jigs, fixtures and other square broaching operations**



Square Push Broaches

Our Standard Square Broaches are designed to generate in one-pass a Standard Square hole in a previously cast or drilled round hole. Standard Square Broaches begin in an oversized pilot hole and generate the square hole while leaving small radii on the flats. Available from stock in the most

common American Standard / Metric sizes (1/8–1" & 4mm–25mm).

TiN or TiAlN coatings available.

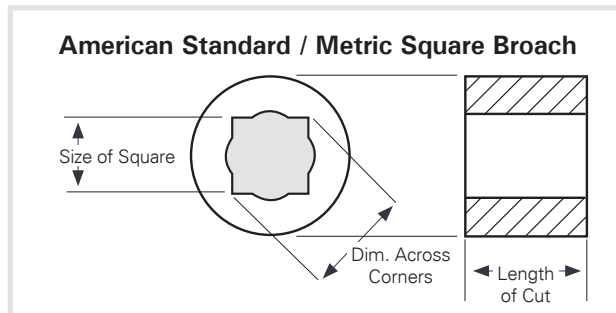

Stock Standard Square Broaches

Square Size (inch)	Tolerances	Broach Length	Pilot Diameter	Drill Size	Dimension Across Corners	Tooth Pitch	Length of Cut		Pressure Required. for Max. L/C (lbs.)	EDP No.	
							Min.	Max.		duMONT	Hassay Savage
1/8	.1255 – .1265	4-1/8	.1285	No. 30	.1750 – .1770	1/8	3/16	1/2	700	66601	13008
5/32	.1565 – .1575	5-1/8	.1590	No. 21	.2180 – .2200	5/32	1/4	1/2	600	66602	13010
3/16	.1880 – .1890	5-9/16	.1935	No. 10	.2620 – .2640		1/4	5/8	1,080	66603	13012
7/32	.2190 – .2200	6-3/8	.2280	No. 1	.3060 – .3080	3/16	1/4	3/4	1,410	66604	13014
1/4	.2505 – .2515	6-1/2	.2656	17/64	.3510 – .3530		1/4	3/4	1,740	66605	13016
9/32	.2815 – .2825	7-3/4	.2969	19/64	.3930 – .3950	7/32	5/16	1	2,130	66606	13018
5/16	.3130 – .3140	7-7/8	.3281	21/64	.4370 – .4390		3/8	1	2,100	66607	13020
11/32	.3440 – .3450	9-3/8	.3594	23/64	.4830 – .4850	1/4	3/8	1-1/4	3,480	66608	13022
3/8	.3755 – .3765	9-3/8	.3906	25/64	.5240 – .5260		3/8	1-1/4	3,720	66609	13024
13/32	.4065 – .4075	10-5/8	.4219	27/64	.5690 – .5710	9/32	1/2	1-3/8	4,080	66610	13026
7/16	.4380 – .4390	10-7/8	.4531	29/64	.6110 – .6130		1/2	1-3/8	4,500	66611	13028
15/32	.4690 – .4700	12	.5000	1/2	.6570 – .6590	5/16	1/2	1-3/8	4,000	66612	13030
1/2	.5005 – .5015	12	.5312	17/32	.6990 – .7010		1/2	1-3/8	4,500	66613	13032
9/16	.5630 – .5640	14-3/4	.5938	19/32	.7870 – .7890	3/8	1/2	1-1/2	5,700	66614	13036
5/8	.6260 – .6270	16-5/16	.6562	21/32	.8730 – .8750		1/2	1-1/2	5,920	66615	13040
11/16	.6885 – .6895	17-3/4	.7500	3/4	.9630 – .9650	7/16	5/8	1-5/8	4,800	66616	13044
3/4	.7510 – .7520	17-3/4	.8125	13/16	1.0450 – 1.0470		5/8	1-5/8	5,940	66617	13048
7/8	.8765 – .8775	22-3/4	.9375	15/16	1.2270 – 1.2290	7/16	5/8	2	9,200	66618	13056
1	1.002 – 1.0030	24-1/8	1.0938	1-3/32	1.4030 – 1.4050		5/8	2	9,200	66619	13064

Stock Metric Standard Square Broaches

Square Size (mm)	Tolerances (Dec. Equiv.)	Broach Length	Pilot Diameter	Drill Size	Dimension Across Corners	Tooth Pitch	Length of Cut		Pressure Required. for Max. L/C (lbs.)	EDP No.	
							Min.	Max.		duMONT	Hassay Savage
4	.1575 – .1580	5-1/8	.1614	4.1	.2205 – .2220	5/32	1/4	1/2	480	66630	17001
5	.1968 – .1973	6-1/2	.2047	5.2	.2765 – .2780		1/4	1/2	800	66631	17002
6	.2362 – .2370	6-11/16	.2519	6.4	.3300 – .3320	3/16	1/4	3/4	1,300	66632	17003
7	.2756 – .2764	7-3/4	.2913	7.4	.3850 – .3870		1/4	3/4	1,800	66633	-
8	.3150 – .3158	7-7/8	.3307	8.4	.4400 – .4420	7/32	3/8	1	2,300	66634	17004
9	.3543 – .3551	9-3/8	.3701	9.4	.4970 – .4990		3/8	1	3,500	66639	-
10	.3937 – .3945	10-1/4	.4094	10.4	.5530 – .5550	1/4	3/8	1-1/4	3,600	66635	17005
12	.4724 – .4732	12	.5039	12.8	.6620 – .6640		3/8	1-1/4	4,200	66636	17006
14	.5512 – .5520	14-3/4	.5826	14.8	.7730 – .7750	5/16	1/2	1-3/8	5,600	66637	17007
16	.6302 – .6310	16-5/16	.6614	16.8	.8790 – .8810		1/2	1-3/8	6,000	66638	17008
18	.7090 – .7097	17-7/8	.7716	19.6	.9930 – .9950	3/8	1/2	1-1/2	5,600	66637	17007
20	.7874 – .7882	20-7/8	.8504	21.6	1.1030 – 1.1050		1/2	1-1/2	6,000	66638	17008
22	.8663 – .8671	22-3/4	.9291	23.6	1.2130 – 1.2150	7/16	5/8	1-5/8	6,600	66641	17010
24	.9453 – .9460	24	1.0079	25.6	1.3230 – 1.3250		5/8	1-5/8	8,900	66642	17011
25	.9845 – .9852	24-1/8	1.0630	27.0	1.3790 – 1.3810	5/8	2	9,200	66643	17012	
									9,200	66644	17013

All standard items are available with TiN or TiAlN coating from stock or short delivery. Please contact Pilot Precision Products for details.

SPECIAL ORDERS: We are fully equipped to manufacture Special Full Square Broaches and Special Metric Square Broaches not listed above to your specifications. Please contact Pilot Precision Products for details.



Full Square Push Broaches

3/16 thru 1/2 inch

Applications: Drives, jigs, fixtures, sizing and finishing

Full Square Broaches

Our Full Square Broaches are designed to generate in one-pass a Full Square hole in a previously cast or drilled round hole. The Broach leaves no radii on the flats of the broached piece and the pilot diameter equals the finished full square size.

TiN or TiAlN coatings available.



Dimensions of Standard Full Square Broach Holes

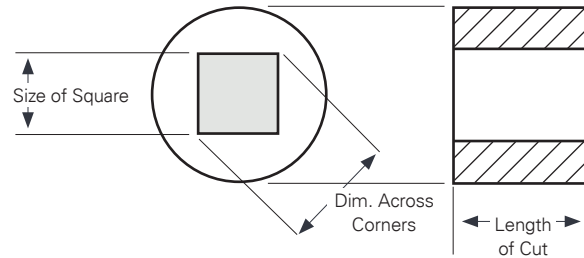

Stock Full Square Broaches

Full Square Size (inch)	Tolerances (Dec. Equiv.)	Broach Length	Pilot Diameter	Drill Size	Dimension Across Corners	Tooth Pitch	Length of Cut		Pressure Required for Max. L/C (lbs.)	EDP No.	
							Min.	Max.		duMONT	Hassay Savage
3/16	.1880 – .1890	6	3/16	3/16	.2630 – .2650	1/8	3/16	1/2	870	66403	14012
1/4	.2505 – .2515	8-1/2	1/4	1/4	.3510 – .3530	5/32	1/4	5/8	1,310	66405	14016
5/16	.3130 – .3140	10-1/2	5/16	5/16	.4390 – .4410	3/16	5/16	7/8	1,895	66407	14020
3/8	.3755 – .3765	13-1/8	3/8	3/8	.5260 – .5280	7/32	5/16	1	2,410	66409	14024
7/16	.4385 – .4395	14-1/4	7/16	7/16	.6140 – .6160	1/4	3/8	1	3,090	66411	14028
1/2	.5005 – .5015	14-3/4	1/2	1/2	.7010 – .7030	1/4	3/8	1	3,860	66413	14032

All standard items are available with TiN or TiAlN coating from stock or short delivery. Please contact Pilot Precision Products for details.

Round Push Broaches

1/4 thru 1 inch

Applications: Drives, jigs, fixtures, sizing and finishing

Round Broaches

duMONT Minute Man® and Hassay Savage Round Broaches are designed to generate in one-pass a precision round hole in a previously cast, drilled or reamed round hole. These Internal Hole Broaches are ideal for precise tolerances, sizing and finish for those applications demanding precision and finish. Broaches are finished with variable pitch teeth and available in American Standard sizes. A burnishing section can be furnished. Metric sizes available upon request.

TiN or TiAlN coatings available.



Stock Round Broaches

Nominal Diameter (inch)	Tolerances	Broach Length	Pilot Diameter	Drill Size	Length of Cut		Pressure Required for Max. L/C (lbs.)	EDP No. duMONT
					Min.	Max.		
1/4	.2505 – .2510	5-7/8	.2344	15/64	5/16	3/4	840	77730
5/16	.3130 – .3135		.2469	19/64			1,050	77731
3/8	.3755 – .3760	6-7/8	.3594	23/64	3/8	1	1,440	77732
7/16	.4380 – .4385		.4219	27/64			1,680	77733
1/2	.5005 – .5010	8	.4844	31/64	1/2	1-1/4	2,240	77734
5/8	.6255 – .6260	8-1/2	.6094	39/64			2,500	77736
3/4	.7505 – .7510	9-1/8	.7344	47/64	5/8	1-1/2	3,720	77738
7/8	.8755 – .8765	9-1/4	.8594	55/64			4,340	77740
1	1.0005 – 1.0015	10-1/4	.9844	63/64	5/8	1-3/4	4,970	77742

Hexagon Push Broaches

1/8 thru 1 inch sizes

4mm thru 25mm sizes



Applications: Drives, jigs, fixtures and other hexagonal broaching operations

Hexagon Broaches

Our Hexagon Broaches are designed to generate in one-pass a Hexagon hole in a previously cast or drilled round hole. Available from stock in the most common American Standard / Metric sizes (1/8–1" & 4mm–25mm).

TiN or TiAlN coatings available.

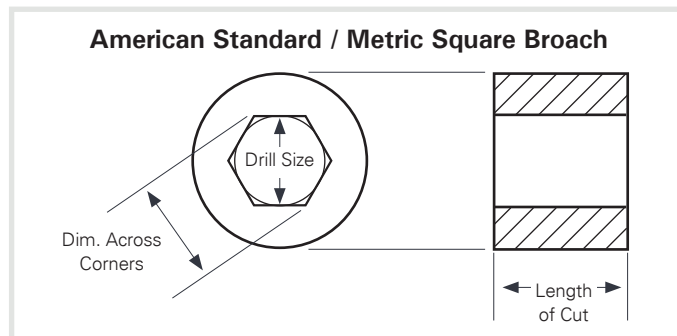

Stock Hexagon Broaches

Hex Size (inch)	Tolerances	Broach Length	Pilot Diameter	Drill Size	Dimension Across Corners	Tooth Pitch	Length of Cut		Pressure Required for Max. L/C (lbs.)	EDP No.	
							Min.	Max.		duMONT	Hassay Savage
1/8	.1255 – .1265	4-1/8	1/8	1/8	.1445 – .1455	1/8	3/16	3/8	200	77701	12008
5/32	.1565 – .1575	4-15/16	5/32	5/32	.1800 – .1815	1/8	1/4	1/2	300	77702	12010
3/16	.1880 – .1890	5-1/16	3/16	3/16	.2160 – .2180	5/32	1/4	5/8	560	77703	12012
7/32	.2190 – .2200	5-3/8	7/32	7/32	.2500 – .2520	5/32	1/4	3/4	775	77704	12014
1/4	.2505 – .2515	6	1/4	1/4	.2870 – .2890	3/16	1/4	3/4	1,025	77705	12016
9/32	.2815 – .2825	7-1/4	9/32	9/32	.3230 – .3250	3/16	5/16	1	1,290	77706	12018
5/16	.3130 – .3140	7-3/4	5/16	5/16	.3590 – .3610	7/32	3/8	1	1,510	77707	12020
11/32	.3440 – .3450	7-3/4	11/32	11/32	.3950 – .3970	7/32	3/8	1-1/4	2,280	77708	12022
3/8	.3755 – .3765	8-1/2	3/8	3/8	.4310 – .4330	7/32	3/8	1-1/4	2,400	77709	12024
13/32	.4065 – .4075	9-5/8	13/32	13/32	.4670 – .4690	7/32	1/2	1-3/8	2,790	77710	12026
7/16	.4380 – .4390	10-1/2	7/16	7/16	.5040 – .5060	1/4	1/2	1-3/8	2,700	77711	12028
15/32	.4690 – .4700	11-7/8	15/32	15/32	.5390 – .5410	9/32	1/2	1-3/8	2,700	77712	12030
1/2	.5005 – .5015	11-7/8	1/2	1/2	.5750 – .5770	9/32	1/2	1-3/8	3,025	77713	12032
9/16	.5630 – .5640	13-3/4	9/16	9/16	.6480 – .6500	5/16	1/2	1-5/8	4,800	77714	12036
5/8	.6260 – .6270	16-1/4	5/8	5/8	.7200 – .7220	5/16	1/2	1-5/8	5,400	77715	12040
11/16	.6885 – .6895	16-3/4	11/16	11/16	.7920 – .7940	5/16	1/2	1-5/8	6,000	77716	12044
3/4	.7510 – .7520	17-1/4	3/4	3/4	.8650 – .8670	3/8	5/8	2	6,960	77717	12048
7/8	.8765 – .8775	18-1/2	7/8	7/8	1.0080 – 1.0100	3/8	5/8	2	8,400	77718	12056
1	1.0020 – 1.0030	19-3/4	1	1	1.1520 – 1.1540	3/8	5/8	2	11,100	77719	12064

Stock Metric Hexagon Broaches

Hexagon (mm)	Tolerances (Dec. Equiv.)	Broach Length	Pilot Diameter	Drill Size	Dimension Across Corners	Tooth Pitch	Length of Cut		Pressure Required for Max. L/C (lbs.)	EDP No.	
							Min.	Max.		duMONT	Hassay Savage
4	.1575 – .1580	4-15/16	.1575	4.0	.1810 – .1825	1/8	1/4	1/2	300	77750	12104
5	.1968 – .1973	5-3/8	.1968	5.0	.2260 – .2275	5/32	1/4	3/4	775	77751	12105
6	.2362 – .2370	6	.2362	6.0	.2710 – .2730	3/16	1/4	3/4	1,025	77752	12106
7	.2756 – .2764	7-1/4	.2756	7.0	.3170 – .3190	7/32	1/4	1	1,290	77753	12107
8	.3150 – .3158	7-3/4	.3150	8.0	.3620 – .3640	7/32	3/8	1	1,510	77754	12108
9	.3545 – .3555	8-1/2	.3543	9.0	.4090 – .4110	1/4	3/8	1-1/4	2,300	77759	-
10	.3937 – .3945	9-5/8	.3937	10.0	.4530 – .4550	9/32	1/2	1-3/8	2,790	77755	12110
12	.4724 – .4732	11-7/8	.4724	12.0	.5430 – .5450	5/16	1/2	1-3/8	2,700	77756	12112
14	.5512 – .5520	13-3/4	.5512	14.0	.6350 – .6370	3/8	1/2	1-5/8	4,800	77757	12114
16	.6302 – .6310	16-1/4	.6299	16.0	.7250 – .7270	3/8	5/8	2	5,400	77758	12116
18	.7092 – .7097	16-3/4	.7087	18.0	.8170 – .8190	3/8	5/8	2	6,400	77760	12118
20	.7876 – .7886	17-5/8	.7874	20.0	.9050 – .9070	3/8	5/8	2	7,200	77761	12120
22	.8664 – .8674	18-1/2	.8661	22.0	.9990 – 1.0010	3/8	5/8	2	8,200	77762	12122
24	.9450 – .9460	19-1/2	.9449	24.0	1.0890 – 1.0910	3/8	5/8	2	9,700	77763	12124
25	.9845 – .9855	19-3/4	.9842	25.0	1.1350 – 1.1370	3/8	5/8	2	11,000	77764	12125



Pull-Type Keyway Broaches

1/16 thru 1 inch sizes



Applications: For high volume production pull-type machines

*Non-Stock Standards - Made to Order

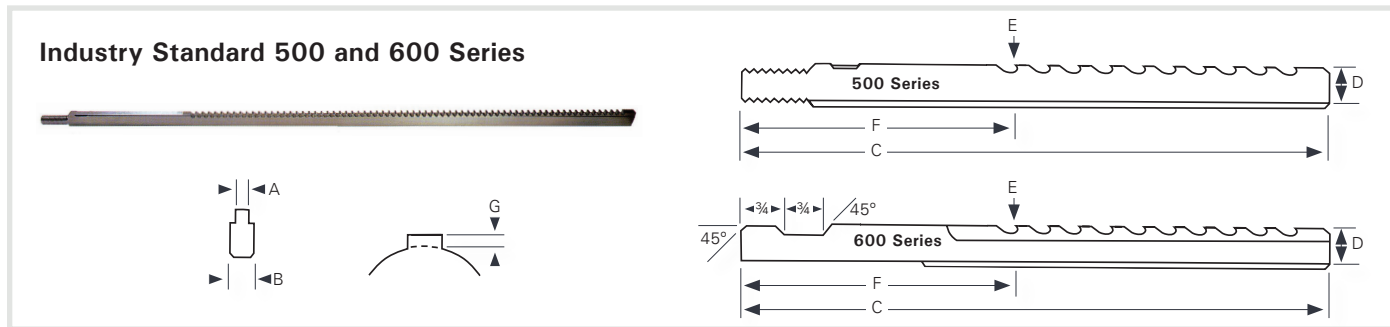

Industry Standard 500 and 600 Series

duMONT Minute Man® and Hassay Savage brands offer the most common American Standard (1/16–1”) Pull-Type Keyway Broaches for use in high volume production. Available either as Industry Standard 500 Series with threaded pull end or 600 Series with notched pull end.

Nom. Dim.	A Decimal Dim.†	Min. Hole Size	Min Length Cut#	Max Length Cut*	B	C	D	E	F	G	No. of Passes	Thread Size	EDP No.			
													duMONT 500 Series	duMONT 600 Series	Hassay 500 Series	Hassay 600 Series
1/16	.0635	3/8	3/8	1-1/4	.1552	20	.313	.271	7-13/16	.042	1	1/4 - 20	10501S	10601S	-	33601
3/32	.0948	7/16	1/2	1-1/2	.1865	24	.367	.309	8-1/4	.058	1	5/16 - 18	10502S	10602S	-	33602
3/32	.0948	9/16	5/8	2-1/2	.2490	33	.491	.433	10	.058	1	3/8 - 16	10503S	10603S	-	33603
1/8	.1260	1/2	1/2	1-1/2	.2490	30	.438	.364	9	.074	1	3/8 - 16	10504S	10604S	-	33604
1/8	.1260	11/16	5/8	2-1/2	.3115	33	.594	.520	10	.074	1	1/2 - 13	10505S	10605S	-	33605
5/32	.1572	19/32	1/2	1-1/2	.2490	30	.525	.436	9	.089	1	3/8 - 16	10506S	10606S	-	33606
5/32	.1572	23/32	5/8	2-1/2	.3115	33	.625	.536	10	.089	1	1/2 - 13	10507S	10607S	-	33607
3/16	.1885	11/16	5/8	2-1/2	.3740	36	.581	.476	10	.105	1	1/2 - 13	10508S	10608S	-	33608
3/16	.1885	7/8	11/16	3-1/2	.3740	36	.796	.691	10-11/16	.105	1	1/2 - 13	10509S	10609S	-	33609
7/32	.2198	11/16	5/8	2-1/2	.3740	33	.557	.437	10	.120	1	1/2 - 13	10510S	10610S	-	33610
7/32	.2198	15/16	11/16	3-1/2	.3740	42	.813	.693	11-1/16	.120	1	1/2 - 13	10511S	10611S	-	33611
1/4	.2510	3/4	5/8	2-1/2	.3740	36	.612	.476	10	.136	1	1/2 - 13	10512S	10612S	-	33612
1/4	.2510	1	11/16	4	.4990	45	.877	.741	12	.136	1	5/8 - 11	10513S	10613S	-	33613
1/4	.2510	1-3/8	7/8	6	.6240	51	1.250	1.114	13-3/4	.136	1	3/4 - 10	10514S	10614S	-	33614
9/32	.2828	7/8	11/16	4	.4990	42	.716	.564	11-5/8	.152	1	5/8 - 11	10515S	10615S	-	33615
9/32	.2828	1-1/4	7/8	6	.4990	51	1.093	.941	13-1/2	.152	1	5/8 - 11	10516S	10616S	-	33616
5/16	.3140	1-1/16	11/16	4	.4990	45	.908	.741	12	.167	1	5/8 - 11	10517S	10617S	-	33617
5/16	.3140	1-5/16	7/8	6	.4990	51	1.158	.991	13-3/4	.167	1	5/8 - 11	10518S	10618S	-	33618
3/8	.3765	1-9/16	11/16	4	.4990	45	.938	.739	12	.199	1	5/8 - 11	10519S	10619S	-	33619
3/8	.3765	1-5/16	7/8	6	.4990	54	1.189	.990	13-1/2	.199	1	5/8 - 11	10520S	10620S	-	33620
7/16	.4390	1-9/16	11/16	4	.6240	48	1.390	1.160	12	.230	1	3/4 - 10	10521S	10621S	-	33621
7/16	.4390	1-3/4	1	8	.6240	48	1.611	1.496	15-5/8	.230	2	3/4 - 10	10522S	10622S	-	33622
1/2	.5015	1-1/2	11/16	4	.6240	48	1.312	1.051	12	.261	1	3/4 - 10	10523S	10623S	-	33623
1/2	.5015	1-9/16	1	8	.6240	48	1.377	1.246	16-1/2	.261	2	3/4 - 10	10524S	10624S	-	33624
9/16	.5645	1-11/16	11/16	4	.6865	54	1.438	1.146	11-13/16	.292	1	1 - 8	10525S	10625S	-	33625
9/16	.5645	1-5/8	1	8	.6865	51	1.391	1.245	16	.292	2	1 - 8	10526S	10626S	-	33626
9/16	.5645	1-15/16	1-1/8	12	.8740	60	1.641	1.495	20	.292	2	1 - 8	10527S	10627S	-	33627
5/8	.6270	1-7/8	1-1/16	4	.7490	60	1.625	1.301	12	.324	1	1 - 8	10528S	10628S	-	33628
5/8	.6270	1-15/16	1	8	.8740	54	1.657	1.495	16-3/8	.324	2	1 - 8	10529S	10629S	-	33629
5/8	.6270	1-15/16	1-1/8	12	.8740	60	1.657	1.495	20	.324	2	1 - 8	10530S	10630S	-	33630
3/4	.7520	1-15/16	11/16	4	.8740	60	1.625	1.239	12	.386	1	1 - 8	10531S	10631S	-	33631
3/4	.7520	2-1/16	1	8	.9990	60	1.688	1.495	16-1/4	.386	2	1-1/4 - 7	10532S	10632S	33532	33632
3/4	.7520	2-1/16	1-1/8	12	.9990	60	1.688	1.560	20	.386	3	1-1/4 - 7	10533S	10633S	33533	33633
7/8	.8770	2-1/4	11/16	4	1.1240	63	1.875	1.426	12-3/8	.449	1	1-1/4 - 7	10534S	10634S	33534	33634
7/8	.8770	2-1/8	1	8	1.1240	63	1.719	1.494	15-3/4	.449	2	1-1/4 - 7	10535S	10635S	33535	33635
7/8	.8770	2-1/8	1-1/8	12	1.1240	63	1.719	1.569	20	.449	3	1-1/4 - 7	10536S	10636S	33536	33636
1	1.0020	2-1/4	5/8	2-1/2	1.2490	63	1.750	1.239	10-1/2	.511	1	1-1/2 - 6	10537S	10637S	33537	33637
1	1.0020	2-1/4	7/8	6	1.2490	63	1.750	1.494	14-1/4	.511	2	1-1/2 - 6	10538S	10638S	33538	33638
1	1.0020	2-1/4	1-1/8	12	1.2490	63	1.750	1.580	20	.511	3	1-1/2 - 6	10539S	10639S	33539	33639

† Tolerance - Based on +/- .0005 # Minimum length of part recommended to prevent part from dropping in between broach teeth *Based on mild steel

All standard items are available with TiN or TiAlN coating from stock or short delivery. Please contact Pilot Precision Products for details.

Note: All items can be made with deburring feature as specials.

Pull-Type Keyway Broaches

2mm thru 25mm



Applications: For high volume production pull-type machines

Metric 2–25mm Pull-type Keyway Broaches

duMONT Minute Man® and Hassay Savage brands offer the most common Metric (2–25mm) Pull-Type Keyway Broaches for use in high volume production. Available either as Industry Standard 500 Series with threaded pull end or 600 Series with notched pull end. See image on page 16.

Nom. Dim.	A Decimal Dim.†	Min. Hole Size (mm)	Min Length Cut#	Max Length Cut*	B	C	D	E	F	G	No. of Passes	Thread Size	EDP No.	
													duMONT 500M Series	duMONT 600M Series
2	.0792	9	9.5	31.8	3.942	508	7.95	6.60	197	1.35	1	1/4 – 20	10561S	10661S
3	.1186	11	12.7	38	4.737	610	9.32	7.49	197	1.83	1	5/16 – 18	10562S	10662S
4	.1581	13	12.7	38	6.325	838	11.13	8.81	229	2.31	1	3/8 – 16	10563S	10663S
	.1581	13	15.9	63.5	6.325	915	11.07	8.76	254	2.31			10564S	10664S
5	.1974	14	14.3	44.5	7.91	915	11.07	8.18	248	2.89	1	1/2 – 13	10565S	10665S
	.1974	23	15.9	76.2	9.5	1067	2.65	17.75	279	2.89			10566S	10666S
6	.2368	18	15.9	63.5	9.5	915	15.54	11.96	254	3.58	1	1/2 – 13	10567S	10667S
	.2368	26	17.5	102	12.67	1143	22.28	18.69	305	3.58			10568S	10668S
8	.3157	27	17.5	102	12.67	1143	23.06	18.77	305	4.29	1	5/8 – 11	10569S	10669S
	.3157	33	22.2	152	12.67	1295	29.41	25.12	353	4.29			10570S	10670S
10	.3944	27	17.5	102	12.67	1143	23.27	18.77	305	4.49	1	5/8 – 11	10571S	10671S
	.3944	36	22.2	152	15.85	1295	31.75	27.25	353	4.49			10572S	10672S
12	.4733	39	17.5	102	15.85	1219	34.06	29.46	302	4.60	1	3/4 – 10	10573S	10673S
	.4733	39	25.4	203	15.85	1524	34.06	29.46	406	4.60			10574S	10674S
14	.552	40	17.5	102	17.44	1372	34.39	29.11	295	5.28	1	1 – 8	10575S	10675S
	.552	44	25.4	203	19.02	1524	38.33	33.04	400	5.28			10576S	10676S
16	.6308	47	17.5	102	19.02	1524	41.28	35.46	305	5.82	1	1 – 8	10577S	10677S
	.6308	48	28.6	305	22.2	1524	41.28	38.35	508	5.82			10578S	10678S
18	.7095	48	17.5	102	22.2	1524	41.28	35.26	305	6.02	1	1 – 8	10579S	10679S
	.7095	51	28.6	305	25.37	1524	42.88	39.85	513	6.02			10580S	10680S
20	.7884	56	17.5	102	28.55	1600	47.63	4.94	302	6.68	1	1-1/4 – 7	10581S	10681S
	.7884	53	28.6	305	28.55	1600	43.66	4.31	503	6.68			10582S	10682S
22	.8672	57	17.5	102	28.55	1600	47.63	4.39	302	7.24	1	1-1/4 – 7	10583S	10683S
	.8672	53	28.6	305	28.55	1600	43.66	4.03	503	7.24			10584S	10684S
25	.9853	56	17.5	102	31.72	1600	44.45	36.98	270	7.47	1	1-1/2 – 6	10585S	10685S
	.9853	56	28.6	305	31.72	1600	44.45	4.72	508	7.47			10586S	10686S

† Tolerance - Based on +/- .0005 # Minimum length of part recommended to prevent part from dropping in between broach teeth *Based on mild steel

All standard items are available with TiN or TiAlN coating from stock or short delivery. Please contact Pilot Precision Products for details.

Note: All items can be made with deburring feature as specials.



Keyseating Broaches

1/16 thru 1-1/2 inch sizes

2mm thru 25mm



Applications: **Hansford Davis Keyseating Machine Models 4, 5, and 15**

Type AF – Inch

Keyseating Broaches feature superior tooth design and are ground to precision keyway tolerances. Sizes for cutting the most common keyway widths are available.

TiN or TiAlN coatings available.

Broach Size (inch)	Overall Length	Tooth Height	Tooth Pitch	EDP No.		
				duMONT	Hassay Savage	
1/16*	16	3/8	3/8	55550	10701	
3/32*				55551	10702	
1/8*		7/16		55552	10703	
5/32*		1/2		55553	10704	
3/16		9/16		55554	10705	
1/4		3/4		55555	10707	
5/16			7/8	17/32	55557	10709
3/8					55559	10711
7/16			1		-	10713
3/16		20	3/8	3/8	-	10706
1/4	3/4		55556		10708	
5/16			7/8	17/32	55558	10710
3/8					55560	10712
7/16				11/32	55561	10714
1/2				17/32	55562	10715
9/16			1		55563	10716
5/8					55564	10717
3/4					55565	10718
7/8					55566	10719
1					55567	10720

*Reinforced body width 3/16" thick

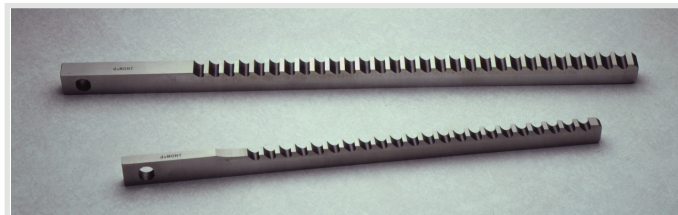

Type AF Metric Standard

Broach Size (mm)	Overall Length	Tooth Height	Tooth Pitch	EDP No.			
				duMONT	Hassay Savage		
2*	16	3/8	3/8	55570	11701		
3*		7/16		55571	11702		
4*		1/2		55572	11703		
5		9/16		55573	11704		
6		3/4		55574	11706		
7				7/8	17/32	55576	-
8					55578	11708	
9					55580	-	
10			7/8		-	11710	
5		20	1/2	3/8	-	11705	
6	3/4		55575		11707		
7			7/8	17/32	55577	-	
8					55579	11709	
9					55581	-	
10					55582	11711	
11						55583	-
12						55584	11712
13				55585	-		
14				55586	11713		
15				55587	-		
16				55588	11714		
17			1		55589	-	
18				55590	11715		
19				55591	-		
20		55592		11716			
22		55593		11717			
24		55594		11718			
25		55595	11719				

*Reinforced body width 3/16" thick

Type AFS – Inch

Staggered Tooth AFS Type Keyseating Broaches provide a stagger tooth design, promoting an efficient cut.

TiN or TiAlN coatings available.

Broach Size (inch)	Overall Length	Tooth Height	EDP No. duMONT	
3/8	20	1	55601	
7/16			55603	
1/2			55604	
9/16			55605	
5/8			55606	
3/4			55607	
7/8			55608	
1			55609	
1-1/8			1-1/8	55610
1-1/4			1-1/4	55611
1-1/2	1-1/2	55612		

All standard items are available with TiN or TiAlN coating from stock or short delivery. Please contact Pilot Precision Products for details.

SPECIAL ORDERS: We are fully equipped to manufacture Special Keyseating Broaches not listed above. Please contact Pilot Precision Products for details.

Arbor Presses and PressLube Broaching Oil

Hand Operated

Arbor Presses

duMONT Minute Man® Arbor Presses are easy to operate Manual Broaching Machines designed for Push Broaching with Keyways and Internal Hole Broaches. These Hand Operated Presses are available in 3- and 5-ton models and provide the pressure required to Push Broaches through the work piece. Both Arbor Presses provide these essential features:

- Ratchet operation with compound leverage for minimum operator effort.
- Pawl between lever and pinion permits positioning lever for most convenient reach and pull.
- Ram positioned by handwheel reduces travel, tests Broach alignment, supports the Broach and workpiece assembly.
- Round ram with rack teeth cut to center concentrates force along the center line to avoid cramping.



	Dake 1 1/2 Arbor Press	Dake 1 1/2 B Arbor Press	Dake 2 1/2 Arbor Press
EDP No.	55004	55006	55008
Stroke	11-1/2	18-1/4	21-1/2
Tonnage	3	3	6
Horsepower	Manual	Manual	Manual
Shipping Weight	220 lbs.	325 lbs.	450 lbs.

Broaching Oil That Keeps Your Tooling Sharp & Disposal Costs Down



Our PressLube™ Broaching Oil* is a proprietary formulation created to improve the performance of your broaching tools without the use of chlorine (Cl) and phosphorous (P). Our environmentally safe lubricant contains a special electrostatic precipitator (EP) additive that combines with active and inactive sulfurized lubricity agents to produce a high-performance broach cutting oil product.

- Improves Part Quality, Surface Finish & Operational Efficiency
- Provides Excellent Rust Protection
- Extends Tool Life
- Minimizes Built-Up Edge
- Increases Rates of Turning
- Easy to Filter
- Environmentally Friendly
- Recyclable
- Reduces Disposal Costs

EDP #	Description
99960	duMONT Broaching Oil 12 x 1 quart/case
99961	duMONT Broaching Oil 4 x 1 gallon/case
99962	duMONT Broaching Oil 5 gallon pail
99963	duMONT Broaching Oil 55 gallon drum
99964	duMONT Broaching Oil 275 gallon tote

*California Proposition 65 - This product does not contain any substances known to the State of California to cause cancer and/or reproductive harm.



Custom Broaches

Push and Pull Types

Applications: **For high volume production pull-type machines**

Spline Broaches

Spline Broaches specifically designed and manufactured for your application, duMONT Minute Man® and Hassay Savage offer straight sided, Involute Spline, and Serration Broaches in both Push or Pull-type designs. Due to the complex nature of these tools a customer part print is required. Pull-type Broaches are available with a variety of pull ends—Threaded, Notched, Pin and Automatic, to name a few.



Keyway Broaches

duMONT Minute Man® and Hassay Savage manufacture Special Keyway Broaches in either Push or Pull-type in both American Standard and Metric Sizes. Special Application Multi-pass Push Keyway Broaches and One-Pass Keyway Broaches which require the appropriate guide Bushing can often be manufactured from an existing blank for quick delivery. One-Pass Push Keyway Broaches are also available in a self-guiding Production Style that require no guide Bushing. Both One-Pass Push-type styles as well as their Pull-type counterparts are available with a special chamfer feature that will deburr the keyway bore interface. Double-Keyway and Keyseating Broaches are also available. Pull-type Broaches are available with a variety of pull ends—Threaded, Notched, Pin, and Automatic, to name a few.



Firearms Custom Broaches

Our Breechface Broaches are easily assembled into a standard CNC holder. They are for use with the pistol brands: Glock, Smith & Wesson, H&K, Walther, CZ and Canik. Calibers include: 9mm, .40, .45, .380 and 10mm. Our Breechface broaches are internal to machine cycle and do not require subcontracting / offline operation. We also offer custom linear Push or Pull broaches made for all firearms broaching applications.



Custom Breechface Broaches for the Following Brands:

- Glock
- Smith & Wesson
- H&K
- Walther
- CZ
- Canik

Firearm Broaches we can support:

- Magwells
- Rifling
- Receiver
- Frame Broaches
- Slotters - Revolver
- Revolver Finishing

Custom Broaches and Re-Sharpener

Push and Pull Types

Applications: **Virtually any broaching operation** | **Short- and long-run production**

Surface Broaches

Surface Broaches are available as either individual Broaches or as inserts for broaching flat surfaces, irregular shapes, external forms, concave or convex surfaces, serrations, cam shapes, corner squaring and dovetails.

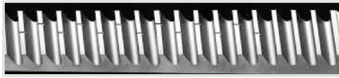

Internal Hole Broaches

Internal Hole Broaches in Push and Pull-type including Square, Hexagon, Round, Rectangular, Keyway, and irregularly shaped Broaches are all readily available. Broaches for Burnishing, Sizing and Combination or Cut and Finish applications are also manufactured as either Push or Pull-type. Pull-type Broaches are available with a variety of pull ends—Threaded, Notched, Pin and Automatic, to name a few.



Let Us Meet Your Custom Broach Requirements

Along with the extensive assortment of Stock Broaches listed in this catalog, we offer short delivery of Special Broaches custom-designed for your application or manufactured from your prints.

Our engineering staff has years of experience designing Special Broaches to replace time-consuming and costly machining operations. Whenever possible, we will meet your Special Broach requirements by using our extensive supply of hardened blank stock, thereby reducing both the cost and delivery time ordinarily associated with ordering Specials. With our extensive stock and expertise in designing and manufacturing specials, we are able to serve our customers as a single complete source for all of their broaching needs.

We are fully equipped to manufacture both Standard and Custom Broaches in either Push or Pull Styles, including all types of Keyway, Internal Hole, and Surface Broaches.

TiN or TiAlN coatings available.

Broach Re-Sharpener

Broaches, regardless of type, should never be used when dull. The use of a dull Broach may result in poor finish or cause drifting, damage to the teeth or breakage. Correct and timely re-sharpening will increase Broach life and quality of parts. The necessity to sharpen a Broach is dependent on numerous factors; material, tolerance, and required finish, etc. A number of conditions indicate the need for sharpening:

- Poor finish, tears, galling, etc. on the workpiece.
- Cutting edges showing signs of rollover and teeth dull to the touch.
- When using a Hydraulic Press, the pressure gauge showing an increase in pressure required to complete the cut.
- Nicks, gouges, etc. in the teeth from improper handling.
- Broach sticking in the workpiece, pick-up on tops of teeth.
- Holes gauging undersize.

duMONT Minute Man® and Hassay Savage offer expert Broach re-sharpening services, with the goal to restore the cutting edges of the Broach to its original condition. Broaches returned for this service are each individually examined and specific regrind instructions are generated for the reconditioning of the tool.

Standard Broaching Procedures

duMONT Minute Man® and Hassay Savage Broaches are designed for fast, accurate, and convenient broaching with arbor or hydraulic presses. A study of the Broaching Procedures presented in this section will familiarize the operator with proper broaching procedures and troubleshooting practices. Following proper broaching fundamentals, paying attention to technique and Broach maintenance will help prevent drifting, deflection and even breakage while providing greater efficiencies in the cutting of your parts. If you have a specific question or problem, contact our Engineering Department at 413-350-5200 or by email at info@pilotprecision.com.

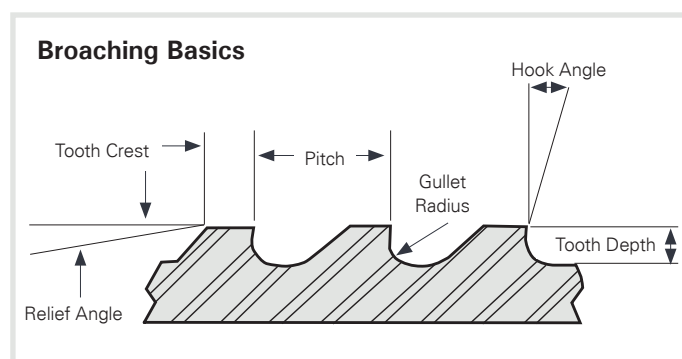

Warning Information

Cutting tools may shatter or break, therefore **eye protection should be worn wherever and whenever cutting tools are being used**. Government Regulations require use of safety glasses and other appropriate safety equipment at all times in the vicinity of cutting tool use.

Workpiece Material

duMONT Minute Man® and Hassay Savage stock Broaches can be used on a variety of workpiece materials. It is not practical to Broach material having a Rockwell hardness higher than Rc35. When broaching **Iron or Steel**, use the standard Broach as supplied. **Brass** and **Free Machining Bronze** may require stoning of a slight land on the top of the teeth to prevent drifting (pulling into the work). Custom Broaches are designed and engineered to provide the correct tooth form, pitch and rake angles for the material specified.

Length of Cut

Our Broaches are designed to be used in operations where a minimum of two teeth are engaged at all times. Tooth engagement is required to maintain a smooth cutting action promoting a clean finish. The chip generated during the cutting process must be contained within the gullet of the tooth to avoid binding of the tool. This could cause potential damage to the Broach, the workpiece and injury to the operator. Appropriate

chip load allows for smooth cutting, and improved tool life. All individual stock Broaches have recommended Minimum and Maximum Length of Cut guidelines which should be followed. The required force necessary to achieve the Maximum Length of Cut is also provided with the individual Broach specifications. Workpieces may be stacked to establish the Minimum Length of Cut, or to improve the efficiencies of the operation as long as Maximum Length of Cut is not exceeded. Proper nesting and clamping of stacked parts is vital when this approach is taken. The Maximum Length of Cut with Push-type Keyway Broaches should not exceed the length of the Bushing being used.

Reminder: "A/I" Style Broaches are used with "A/I" Style Bushings, "B/II" Style Broaches with "B/II" Style Bushings, etc. Pilot Precision Products Push-type and Pull-type Broaches often can be designed to accommodate your specific length of cut requirements.

Set-Up and Alignment

Successful broaching begins with proper set-up, and alignment of the Broach, workpiece and ram. Attention to these details will provide a stable workpiece, and prevent drifting, deflection or even breakage caused by misalignment. The workpiece must be solidly fixed or nested perfectly square with the baseplate and ram face. Make sure all square and parallel surfaces on the face of the ram and baseplate remain true. It is essential to maintain a rigid set-up at all times and caution should be taken when stacking parts to maintain the integrity of the set-up. Never attempt to exceed the Broach's specified Maximum Length of Cut. At the beginning of a cut, be sure the Broach is centered under the ram. Proper alignment is important. After the Broach starts to cut, back off pressure on the ram to allow the Broach to center itself, if not in perfect alignment. If Broach moves out of alignment after starting cut, back off the pressure on the ram and align the broach itself. Repeat this procedure during successive cuts. This will assure a perfectly straight broached hole.

Suggestions for a drifting or "hogging" Push-type Keyway Broach:

1. Reverse workpiece or turn Broach so teeth face toward the back of the press.
2. Let the Bushing protrude above the workpiece to give more support to the back of the Broach, thereby helping to keep it aligned. If a collared Bushing is used, place it upside down under the workpiece.

Ram Adapter Use

Ram Adapters are used for broaching applications that require Round, Custom Shapes such as Rectangular as well as Square, and Hexagon Broaches 1/4" and 6mm or smaller. A Ram Adapter would also be recommended in situations where an extraordinary high degree of accuracy is required.

Applications: **Standard Push Broaching Procedures** | **Broach Re-Sharpening**

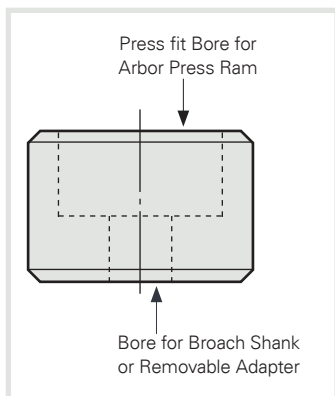

These Adapters are also referred to as rear guides and provide support and guidance for the Broach at the shank end, minimizing the possibility of deflection or breakage. When an Adapter is used as a rear guide for the Broach, the hole in the Ram Adapter must be in alignment with the pilot hole in the workpiece. It is important a Ram Adapter provides a tight, true fit to both the press ram and to the Broach shank. An adapter may also be used to allow the shanks of smaller Internal Hole Broaches to be gripped to avoid deflection and breakage.

Cutting Fluids and Lubrication

Broach lubrication is crucial to tool life and the quality of the finish produced. Lubrication enables chips to slide freely and curl in the tooth gullets minimizing frictional heat. This cuts down on Broach wear and prevents build up on the cutting edge of the teeth. Push-type Keyway Broaches, regardless of the material to be broached, require lubrication on the back side of the Broach in order to reduce friction. Proper lubrication will increase Broach life and produce a cleaner finish. Various materials require different lubricants.

Mild Steel – A good quality cutting oil is preferred but water-soluble coolant is ok. Apply on the teeth and back side of the broach.

Tough Steels such as Nickel Alloys – A good grade of a sulfur-based cutting oil.

Brass – Can be broached dry, but Oil is preferred.

Bronze – Works best with oil.

Cast Iron – Is almost always broached dry.

Aluminum – A good quality cutting oil is preferred but water-soluble coolant is OK. Apply on the teeth and back side of the broach.

Coatings Available

duMONT Minute Man® and Hassay Savage Broaches are available with TiN, and TiAlN coatings. The coatings provide enhanced performance for specific applications, delivering greater value and tool life on your more challenging materials.

TiN – provides increased lubricity and wear resistance when broaching abrasive materials such as fiberglass and some aluminum alloys.

TiAlN – offers significant increase in surface hardness (Rc low 90s). Applications would include broaching in most stainless steels, alloy steels and harder materials.

Broaching with Keyway Sets or Individual Broaches



Use of Individual Push-type Keyway Broaches or Keyway Broaches from a Broach Set requires the use of a Bushing and Shim(s). The Bushing size and style are determined by the bore diameter of the workpiece as well as the Style of Broach to be used. "A / I" Style Broaches are used with "A / I" Style Bushings, "B / II" style Broaches with "B / II" Style Bushings, etc. The smallest Broaches cut in one pass and require no Shim. Multiple pass Keyway Broaches

are furnished with all necessary Shim(s) unless otherwise noted. A Shim is required to compensate for the thickness removed following a Keyway Broach's cutting pass. The addition of a Shim to the bottom of the bushing's slot serves to move the Broach forward toward its standard finished cutting depth. Subsequent passes require the stacking of Shims.

1. Select the right Broach for the bore (sizes are plainly marked).
2. Insert Broach (which is also plainly marked for size) and check alignment.
3. Place this assembly in the press.
4. Lubricate.
5. Apply pressure to the Broach—back off pressure on Ram to allow the Broach to center itself if not in perfect alignment—reapply pressure to push Broach through the work.
6. Clean Broach using a stiff brush to remove chips from cutting section.
7. Insert shim and repeat steps 3 through 6 as required to obtain exact keyway depth.

*Find our Oil on Page 25



Applications: **Broaching with Keyway Sets and Production Keyway Broaches**

Broaching with One-Pass Keyway Broaches



Broaching with One-Pass Keyway Broaches requires the use of a Bushing. The Bushing size and Style are determined by the bore diameter of the workpiece as well as the Style of Broach to be used. "A/I" Style Broaches are used with "A/I" Style Bushings, "B/II" Style Broaches with "B/II" Style Bushings, etc. No Shims are required. The Broach cuts to full width and depth in one pass.

1. Select the right Bushing for the bore (sizes are plainly marked) and insert in the bore of work.
2. Insert Broach (which is also plainly marked for size) for the desired width of keyway into the Bushing slot and check alignment.
3. Place this assembly in the press.
4. Lubricate.
5. Apply pressure to the Broach—back off pressure on Ram to allow the Broach to center itself, if not in perfect alignment—reapply pressure to push Broach through the work.
6. Clean Broach using a stiff brush to remove chips from cutting section.
7. Repeat steps 2 thru 6 for subsequent parts.

Broaching with Production Keyway Broaches

Broaching with Production Style Keyway Broaches requires no Shims or Bushings. The back and shoulders of the Broach are ground to fit the diameter of the bore, supporting and guiding itself while cutting the keyway in one pass.

1. Select desired Broach and insert pilot into bore of part.
2. Lubricate.
3. Apply pressure to the Broach—back off pressure on Ram to allow the Broach to center itself, if not in perfect alignment.
4. Clean Broach using a stiff brush to remove chips from cutting section.
5. Repeat steps 2 through 4 for subsequent passes.

Broaching with Internal Hole Broaches



Broaching with Internal Hole Broaches requires no Shims or Bushings. Round, Square, Hexagon and many Custom Shapes are designed to finish in one pass, in cast or drilled bores requiring a thru hole finish. The starting hole must be drilled square with the face of the work. Square and Hexagon Broaches, 1/4" and 6mm or smaller, should be gripped by the shank in an adapter to prevent deflection and breakage.

1. Pilot Holes: Properly drilled pilot holes are essential for a true and clean cut. Never use a dull or poorly sharpened drill to make pilot holes.
2. Select desired Broach. Confirm the bore of workpiece is equal to pilot diameter of broach. (The use of a ram adapter is advised with all Round Broaches and for Square and Hexagon Broaches 1/4" and 6mm or smaller).
3. Insert pilot into bore of part.
4. Ram Speed: Always use proper ram speed to prevent chatter marks and edge wear. (See Metals Handbook – Vol. 3 "Machining".)
5. Lubricate.
6. Apply pressure to the Broach—back off pressure on Ram to allow the Broach to center itself, if not in perfect alignment—reapply pressure to push Broach through the work.
7. Clean Broach using a stiff brush to remove chips from cutting section.
8. Repeat steps 3 through 7 for subsequent parts.

Troubleshooting

We aim to make your broaching experience efficient, effective and trouble-free. Most broaching failures (poor finish, drifting, deflection, breakage, chatter marks or edge wear) can be attributed to deficiencies in alignment, lubrication, Broach sharpness, tooth configuration or design, material hardness and incorrect broaching speed or pressure as detailed in this section. If you have specific questions or problems not covered on these pages, contact our Engineering Department.

To the Distributor

duMONT Minute Man® and Hassay Savage broaches offer your customers the benefits of advanced design and the latest market technology in manufacturing. Our strict quality controls and skilled group of toolmakers ensure that Pilot Precision Products broaches cut more precisely, last longer and wear better to make money for you and your customers.

duMONT Minute Man® and Hassay Savage offer:

- Unsurpassed high-quality products made by experienced toolmakers
- Consistent product mix
- Excellent profit structure
- Timely service
- Pride in what we do
- Experienced craftsmanship



(Industrial Supply Association) we are organized by the ISA standard numbering system. Pilot Precision Products Code - 615948 (Uniform Code Council).

Warranty

Pilot Precision Products, warrants to original equipment manufacturers, distributors and industrial and commercial users of its products that each new product manufactured or supplied by Pilot Precision Products, shall be free from defects in material and workmanship. Pilot Precision Products, obligation under this warranty is limited to furnishing without additional charge a replacement or, at its option, repairing or issuing credit for any product which shall within one year from the date of sale be returned freight prepaid to the plant designated by Pilot Precision Products, representative and which upon inspection is determined by Pilot Precision Products, to be defective in materials or workmanship. Complete information as to operating conditions, machine setup, and application of cutting fluid should accompany any product returned for inspection. The provisions of this warranty shall not apply to any Pilot Precision Products Tools, product which has been subjected to misuse, improper operating conditions, machine setup or application of cutting fluid or

which has been repaired or altered if such repair or alteration in the judgment of Pilot Precision Products, would adversely affect performance of the product. THIS WARRANTY IS IN LIEU OF ALL OTHER WARRANTIES, EXPRESSED OR IMPLIED, INCLUDING ANY IMPLIED WARRANTY OF MERCHANTABILITY OR FITNESS FOR A PARTICULAR PURPOSE. Pilot Precision Products, shall have no liability or responsibility on any claim of any kind, whether in contract, tort or otherwise, for any loss or damage arising out of, connected with, or resulting from the manufacture, sale, delivery or use of any product sold hereunder, in excess of the cost of replacement or repair as provided herein. IN NO EVENT SHALL Pilot Precision Products, BE LIABLE FOR ANY SPECIAL, INCIDENTAL OR CONSEQUENTIAL DAMAGES. Pilot Precision Products, makes no other warranty, expressed or implied, except as set forth above; and Pilot Precision Products, neither assumes nor authorizes any other person or entity to assume for it any other obligation or liability in connection with any of its products.

Warning: *Cutting tools may shatter or break, therefore eye protection should be worn wherever and whenever cutting tools are being used. Government regulations require use of safety glasses and other appropriate safety equipment at all times in the vicinity of cutting tool use.*

duMONT CNC
Indexable Broaching System

PILDT

Table of Contents

Introduction.....	35
duMONT CNC Broaching Kits	36-37
Stock Tool Holders for Keyway and Slotting Inserts (Inch).....	38
Stock Tool Holders for Keyway and Slotting Inserts (Metric).....	39
Broaching and Slotting Inserts - Imperial.....	40
Broaching and Slotting Inserts - Metric.....	41
MAX HP Inserts	42
Tools for Splined Profiles	43
Tools and Inserts for Square	44
Tools and Inserts for Hexagon.....	45
Charging Handle for CNC Broaching Kit.....	46
AR Firearm CNC Broaching Kits.....	47
1911 CNC Broaching Kit.....	48
Stock Eccentric Bushings	49
Stock Square Adaptors.....	49
Stock Centering Plates.....	50
Stock Sharpening Stems.....	50
Insert Mounting Screws and Torx Drivers.....	51
Stock Swivel Ball-Bearing Point Set Screws	51
Motorized Slotter.....	52
duMONT CNC Slotter DIY Kit	53
MH Slotting Series Insert Holder	54
MH Square Series Insert Holder.....	55
MH Hexagon Series Insert Holder	56
MH-Spline Series Insert Holder.....	57
MH-M Series Tool Holder Adaptor for the MINITOOL.....	58
MINITOOL	58
Index Broaching.....	59
Engineering.....	60-61

Accurate and Efficient

The duMONT CNC Indexable Broaching System offers a patented solution for effective and efficient broaching and shaping operations on CNC Lathes and Machining Centers as well as Slotting and shaping machines. The CNC Indexable Broaching system is designed to be flexible while delivering the rigidity and performance required. The CNC Indexable Broaching system allows the cutting of thru and blind hole keyways, keyways in a tapered bore and shaped or splined holes. Programming assistance is available, please refer to PilotPrecision.com or call 413-350-5200 for details.

System Components

Inserts – Stock Keyway and Slotting Inserts in Inch and Metric Sizes

The Insert designed to work exclusively with a duMONT Tool Holder is manufactured from a sintered steel alloy with a 13% cobalt content, heat treated to a 72 HRC hardness to provide toughness and impact resistance, and TiN coated to further enhance performance. Stock Inserts may be re-sharpened two to three times depending on the keyway width tolerance and requires recoating after re-sharpening. The Engineering Section discusses additional types of Special Inserts that may be designed and manufactured for specific applications.

Tool Holders – 25 & 32mm and 1 & 1-1/4 in Shank Tool Holders

The duMONT Tool Holder is designed to work exclusively with the Insert. The Holders are manufactured of heat treated tool steel hardened to 58/60 HRC at the Insert seat, providing resistance to deformation and longer tool life. The Tool Holders come in Standard and Long Lengths and can, in many cases, accommodate more than one insert size. The Stock Tool Holders are often used in conjunction with Special Form Inserts designed for specific applications.

Square Adaptors – Square Adaptors for use on Traditional Slotting, and Shaping Machines

The Square Adaptors provide a means of interfacing the Broaching System to a wide variety of conventional Slotting and Shaping Machines. The Square Adaptors are available in 1.378 (35mm) and 1.575 (40mm) size and accept the 25mm Tool Holder and 32mm Tool Holder respectively.

Centering Plates – Centering Plates for use in Tool Holders

The appropriate size Centering Plate is mounted in the Tool Holder to facilitate correct mounting and orientation of the Tool Holder with the machine. Through the use of a sensor or dial indicator, the centering of the Plate will be readily transferred to the Insert when mounted in the Tool Holder.

Sharpening Stems – Sharpening Stems for Stock Inserts

Hexagon shanked Sharpening Stems are available for mounting and supporting an Insert during re-sharpening. Inserts that show a decline in surface finish (a sign of wear), can have their life extended through a re-sharpening process. The Inserts are designed to allow two to three re-sharpenings, more if tolerances allow. Recoating of the Insert is required after sharpening.

Eccentric Bushings – Eccentric Bushings for 25mm and 32mm Tool Holders

The Eccentric Bushings are designed to facilitate the use of the Tooling System in Lathes that do not have a Y-axis adjustment. The Eccentric Bushing has a range of +/- .020 (0.5mm) and provides gradient lines each representing a displacement of .001 (0.03mm). This movement should be sufficient to adjust for any error that may occur on a CNC Lathe and insure proper alignment. The Bushings are also available in the shorter VDI style.

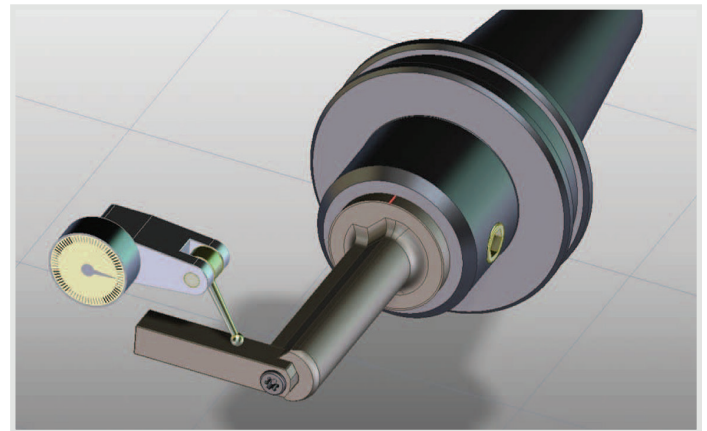

Mounting Screws – Insert Mounting Screws, Drivers and Set

Screw Inserts are mounted in the Tool Holder using a Torx Screw or a 5mm Hex Screw. The Screw size varies with the size of the Insert and Tool Holder. Replacement and extra Screws are available to avoid downtime, as are Torx Drivers as needed. Swivel Ball-Bearing Point Set Screws are used only in Lathes without Y-axis during Eccentric Bushing rotation to correct symmetry errors. Do not over-tighten the Ball-Bearing Point Set Screw – it must allow the Tool Holder to move up and down as the Bushing is rotated.



duMONT CNC Broaching Kits

Indexable Broaching Systems Combine Flexibility & Rigidity to Deliver Superior Performance

With generations of experience delivering American-crafted precision broaching tools, our passion for developing new technologies that solve problems gives our Indexable Broaching Systems the ability to improve productivity, quality and consistency in ways that stand the test of time.

Our CNC Broaching Kits are designed to conveniently give you a wide range of capabilities for your applications at a better value than buying individually.



632 Kit - 6 Piece Kit, 32mm Shank	
EDP #	Description
KIT-BC-632	CNC Broach Concierge Kit with 6 Standard 32mm shank dia. Tools #5, 6, 8, 10, 12, 14/16 tool holders with 1 insert / each, in a metal rack & T8,T15,T20 Torx Drivers
Includes	
99036	UT-5-32 32mm DIAMETER TOOL HOLDER
99038	UT-6-32 32mm DIAMETER TOOL HOLDER
99040	UT-8-32 32mm DIAMETER TOOL HOLDER
99042	UT-10-32 32mm DIAMETER TOOL HOLDER
99044	UT-12-32 32mm DIAMETER TOOL HOLDER
99046	UT-14/16-32 32mm DIAMETER TOOL HOLDER
99207	IN-3/16-H7 KEYWAY INSERT
99209	IN-1/4-H7 KEYWAY INSERT
99212	IN-5/16-H7 KEYWAY INSERT
99213	IN-3/8-H7 KEYWAY INSERT
99215	IN-1/2-H7 KEYWAY INSERT
99216	IN-5/8-H7 KEYWAY INSERT
99561	T8 TORX DRIVER
99562	T15 TORX DRIVER
99563	T20 TORX DRIVER

632L Kit - 6 Piece Kit, 32mm Shank - Long	
EDP #	Description
KIT-BC-632L	CNC Broach Concierge Kit with 6 Long 32mm shank dia. Tools #5, 6, 8, 10, 12, 14/16 tool holders with 1 insert / each, in a metal rack & T8,T15,T20 Torx Drivers
Includes	
99037	UT-5-32-L 32mm DIAMETER TOOL HOLDER
99039	UT-6-32-L 32mm DIAMETER TOOL HOLDER
99041	UT-8-32-L 32mm DIAMETER TOOL HOLDER
99043	UT-10-32-L 32mm DIAMETER TOOL HOLDER
99045	UT-12-32-L 32mm DIAMETER TOOL HOLDER
99047	UT-14/16-32-L 32mm DIAMETER TOOL HOLDER
99207	IN-3/16-H7 KEYWAY INSERT
99209	IN-1/4-H7 KEYWAY INSERT
99212	IN-5/16-H7 KEYWAY INSERT
99213	IN-3/8-H7 KEYWAY INSERT
99215	IN-1/2-H7 KEYWAY INSERT
99216	IN-5/8-H7 KEYWAY INSERT
99561	T8 TORX DRIVER
99562	T15 TORX DRIVER
99563	T20 TORX DRIVER



duMONT CNC Broaching Kits

725 Kit - 7 Piece Kit, 25mm Shank	
EDP #	Description
KIT-BC-725	CNC Broach Concierge Kit with 7 Standard 25mm Shank Tool #2, 3, 4, 5, 6, 8, 10 tool holder with 1 insert / each, in a metal rack & T8,T15,T20 Torx Drivers
Includes	
99000	UT-2-25 25mm DIAMETER TOOL HOLDER
99002	UT-3-25 25mm DIAMETER TOOL HOLDER
99004	UT-4-25 25mm DIAMETER TOOL HOLDER
99006	UT-5-25 25mm DIAMETER TOOL HOLDER
99008	UT-6-25 25mm DIAMETER TOOL HOLDER
99010	UT-8-25 25mm DIAMETER TOOL HOLDER
99012	UT-10-25 25mm DIAMETER TOOL HOLDER
99202	IN-3/32-H7 KEYWAY INSERT
99203	IN-1/8-H7 KEYWAY INSERT
99206	IN-5/32-H7 KEYWAY INSERT
99207	IN-3/16-H7 KEYWAY INSERT
99209	IN-1/4-H7 KEYWAY INSERT
99212	IN-5/16-H7 KEYWAY INSERT
99213	IN-3/8-H7 KEYWAY INSERT
99561	T8 TORX DRIVER
99562	T15 TORX DRIVER
99563	T20 TORX DRIVER

725L Kit - 7 Piece Kit, 25mm Shank - Long	
EDP #	Description
KIT-BC-725L	CNC Broach Concierge Kit with 7 Long 25mm Shank Tool #2, 3, 4, 5, 6, 8, 10 tool holder with 1 insert / each, in a metal rack & T8,T15,T20 Torx Drivers
Includes	
99001	UT-2-25-L 25mm DIAMETER TOOL HOLDER
99003	UT-3-25-L 25mm DIAMETER TOOL HOLDER
99005	UT-4-25-L 25mm DIAMETER TOOL HOLDER
99007	UT-5-25-L 25mm DIAMETER TOOL HOLDER
99009	UT-6-25-L 25mm DIAMETER TOOL HOLDER
99011	UT-8-25-L 25mm DIAMETER TOOL HOLDER
99013	UT-10-25-L 25mm DIAMETER TOOL HOLDER
99202	IN-3/32-H7 KEYWAY INSERT
99203	IN-1/8-H7 KEYWAY INSERT
99206	IN-5/32-H7 KEYWAY INSERT
99207	IN-3/16-H7 KEYWAY INSERT
99209	IN-1/4-H7 KEYWAY INSERT
99212	IN-5/16-H7 KEYWAY INSERT
99213	IN-3/8-H7 KEYWAY INSERT
99561	T8 TORX DRIVER
99562	T15 TORX DRIVER
99563	T20 TORX DRIVER

6SQ25-32 Kits - 6 Piece Kit, 25mm or 32mm Shank - Square		
EDP #	Description	
KIT-BC-6SQ25 or 32	CNC Square Broach Concierge Kit with 6 tool holders in 25mm or 32mm Shank with 1 insert / each, in a metal rack & T8,T15,T20 Torx Drivers	
Includes (25mm or 32mm):		
25mm	32mm	
99621	99622	UT-SQ-8/10 SQUARE TOOL HOLDER SHANK
99623	99624	UT-SQ-10/13 SQUARE INSERT TOOL HOLDER SHANK
99625	99626	UT-SQ-13/16 SQUARE INSERT TOOL HOLDER SHANK
99627	99628	UT-SQ-16/19 SQUARE INSERT TOOL HOLDER SHANK
99629	99630	UT-SQ-19/27 SQUARE INSERT TOOL HOLDER SHANK
99631	99632	UT-SQ-27/37 SQUARE INSERT TOOL HOLDER SHANK
Inserts		
99601	SQ-8/10 SQUARE INSERT	
99602	IN-SQ-10/13 SQUARE INSERT	
99603	IN-SQ-13/16 SQUARE INSERT	
99604	IN-SQ-16/19 SQUARE INSERT	
99605	IN-SQ-19/27 SQUARE INSERT	
99606	IN-SQ-27/37 SQUARE INSERT	
99561	T8 TORX DRIVER	
99562	T15 TORX DRIVER	
99563	T20 TORX DRIVER	

6HX32 Kit - 6 Piece Kit, 32mm Shank - Hex	
EDP #	Description
KIT-BC-6HX32	CNC Hex Broach Concierge Kit with 6 tool holders in 32mm Shank with 1 insert / each, in a metal rack & T8,T15,T20 Torx Drivers
Includes	
99722	UT-HEX-9/11-32 HEX TOOL HOLDER 32MM SHANK
99724	UT-HEX-11/17-32 HEX TOOL HOLDER 32MM SHANK
99726	UT-HEX-17/28-32 HEX TOOL HOLDER 32MM SHANK
99728	UT-HEX-28/37-32 HEX TOOL HOLDER 32MM SHANK
99730	UT-HEX-37/45-32 HEX TOOL HOLDER 32MM SHANK
99731	UT-HEX-45/70-32 HEX TOOL HOLDER 32MM SHANK
Inserts	
99701	IN-HEX-9/11 HEX INSERT
99702	IN-HEX-11/17 HEX INSERT
99703	IN-HEX-17/28 HEX INSERT
99704	IN-HEX-28/36 HEX INSERT
99705	IN-HEX-37/45 HEX INSERT
99706	IN-HEX-45/70 HEX INSERT
99561	T8 TORX DRIVER
99562	T15 TORX DRIVER
99563	T20 TORX DRIVER
99563	T20 TORX DRIVER

Stock Tool Holders for Keyway and Slotting Inserts (Inch)

The Tool Holders designed to work exclusively with duMONT Stock Keyway and Slotting Inserts are heat treated tool steel, hardened to 58/60 HRC at the Insert seat providing resistance to deformation and longer tool life. Most Tool Holders provide two 3.5mm holes for Thru Tool Coolant delivery promoting lubrication, cooling and chip flushing improving finish and tool performance. Available in 1 inch and 1.25 inch diameters in both Standard and Long Lengths designated by -S and -L respectively. Always confirm that the first digit in the Description of the Tool Holder Size matches the Tool Holder Size for the Insert to be used - i.e. Tool Holder Description 6-S for 1 inch shank diameter (EDP No. 99108) could be used with Inserts 1/4 inch (EDP No. 99209) or 6mm (EDP No. 99406). See the Engineering Section for additional process and Special Insert information and available applications — Keyways in Tapered Bore, Square, Hexagon and Involute Internal Gears.

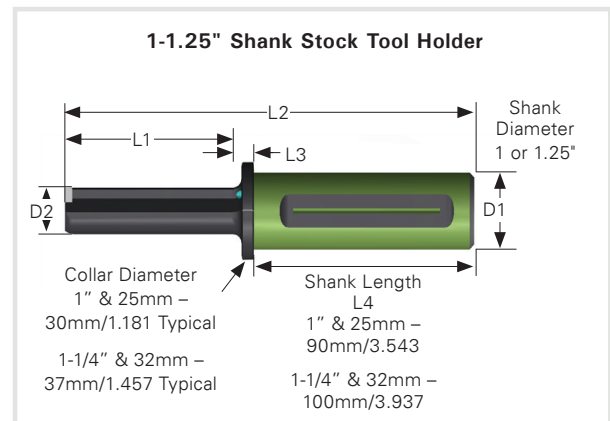

1 & 1.25 Inch Shank Stock Tool Holders for Keyway and Slotting Inserts

Description provides: Tool Holder Size — Length Designation Standard or Long.

See Pages 50-51 for Accessories.

NEW for 2022

Tool Holder Accessories										
EDP - 1 in Shank D1	"EDP - 1.25 in Shank D1"	Description Tool Holder Size	Minimum Bore Dia. (inch)	Stem Dia. (D2) (inch)	Stem Length (L1) (inch)	Overall Length (L2) (inch)	Centering Plate	Mounting Screw	Driver	Thru Tool Coolant
99100	99130	2-S	.314	.256	.984	4.882	CP-0	MS-1	T08	Yes
99101	99131	2-L	.314	.256	1.378	5.276	CP-0	MS-1	T08	Yes
99102	99132	3-S	.354	.315	1.181	5.079	CP-1	MS-1	T08	Yes
99103	99133	3-L	.354	.315	1.575	5.472	CP-1	MS-1	T08	Yes
99104	99134	4-S	.452	.394	1.575	5.472	CP-1	MS-1	T08	Yes
99105	99135	4-L	.452	.394	2.205	6.102	CP-1	MS-1	T08	Yes
99106	99136	5-S	.531	.472	1.811	5.709	CP-1	MS-1	T08	Yes
99107	99137	5-L	.531	.472	2.598	6.496	CP-1	MS-1	T08	Yes
99108	99138	6-S	.708	.630	2.205	6.102	CP-2	MS-2	T15	Yes
99109	99139	6-L	.708	.630	3.189	7.087	CP-2	MS-2	T15	Yes
99110	99140	8-S	.885	.787	2.677	6.378	CP-2	MS-2	T15	Yes
99111	99141	8-L	.885	.787	3.937	7.825	CP-2	MS-2	T15	Yes
99112	99142	10-S*	1.102	.984	3.386	7.284	CP-3	MS-3	T20	No
99113	99143	10-L	1.102	.984	4.961	8.858	CP-3	MS-3	T20	No
99114	99144	12-S*	1.299	1.181	4.016	7.992	CP-3	MS-3	T20	No
99115	99145	12-L	1.299	1.181	6.339	10.236	CP-3	MS-3	T20	No
-	99146	14/16-S	1.574	1.378	4.961	9.094	CP-4	MS-3	T20	No
-	99147	14/16-L	1.574	1.378	7.087	11.220	CP-4	MS-3	T20	No
-	99148	18/25-S*	1.850	1.575	5.512	9.803	CP-5	MS-4	5mm-Hex	No
-	99149	18/25-L*	1.850	1.575	7.874	12.165	CP-5	MS-4	5mm-Hex	No

*Collar Length .433 inch

Stock Tool Holders for Keyway and Slotting Inserts (mm)

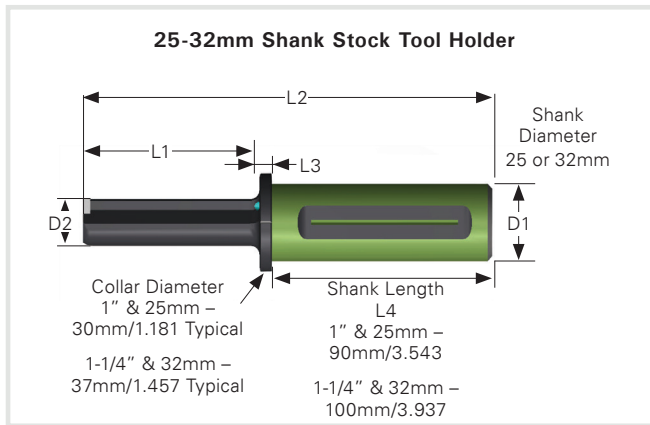

25 & 32mm Shank Stock Tool Holders for Keyway and Slotting Inserts

Description provides: Tool Holder Size — Length Designation Standard or Long.
 See Pages 50-51 for Accessories.

Tool Holder Accessories											
EDP - 25mm Shank D1"	EDP - 32mm Shank D1"	Description Tool Holder Size	Minimum Bore Dia. (mm)	Stem Dia. (D2) (mm)	Stem Length (L1) (mm)	Overall Length (L2) (mm)	Centering Plate	Mounting Screw	Driver	Thru Tool Coolant	
99000	99030	2-S	8	6.5	25	124	CP-0	MS-1	T08	Yes	
99001	99031	2-L	8	6.5	35	134	CP-0	MS-1	T08	Yes	
99002	99032	3-S	9	8	30	129	CP-1	MS-1	T08	Yes	
99003	99033	3-L	9	8	40	139	CP-1	MS-1	T08	Yes	
99004	99034	4-S	11.5	10	40	139	CP-1	MS-1	T08	Yes	
99005	99035	4-L	11.5	10	56	155	CP-1	MS-1	T08	Yes	
99006	99036	5-S	13.5	12	46	145	CP-1	MS-1	T08	Yes	
99007	99037	5-L	13.5	12	66	165	CP-1	MS-1	T08	Yes	
99008	99038	6-S	18	16	56	155	CP-2	MS-2	T15	Yes	
99009	99039	6-L	18	16	81	182	CP-2	MS-2	T15	Yes	
99010	99040	8-S	22.5	20	68	162	CP-2	MS-2	T15	Yes	
99011	99041	8-L	22.5	20	100	199	CP-2	MS-2	T15	Yes	
99012	99042	10-S*	28	25	86	185	CP-3	MS-3	T20	No	
99013	99043	10-L	28	25	126	225	CP-3	MS-3	T20	No	
99014	99044	12-S*	33	30	102	203	CP-3	MS-3	T20	No	
99015	99045	12-L	33	30	161	260	CP-3	MS-3	T20	No	
-	99046	14/16-S	40	35	126	231	CP-4	MS-3	T20	No	
-	99047	14/16-L	40	35	180	285	CP-4	MS-3	T20	No	
-	99048	18/25-S*	47	40	140	249	CP-5	MS-4	5mm-Hex	No	
-	99049	18/25-L*	47	40	200	309	CP-5	MS-4	5mm-Hex	No	

*Collar Length 11mm

Tools for External Machining

The series of tools for external machining was developed for external surfaces (to execute splines and keyway seatings, among others). These tools are made with tool steel. In addition to the two types of tools for external machining available in the catalog, Pilot Precision Products is able to build special tools for external machining based on specific customer demands.

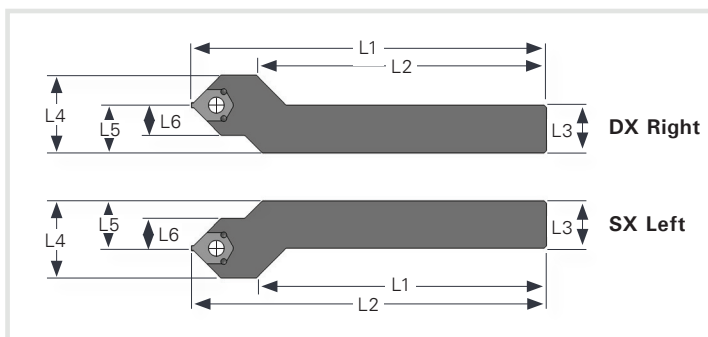

Tools for External Machining (mm)							
EDP No.	Description	L1 (mm)	L2 (mm)	L3 (mm)	L4 (mm)	L5 (mm)	L6 (mm)
99901	20-DX	150.0	110.0	20x20	32.5	20	12.5
99902	20-SX			20x20	32.5	20	
99903	25-DX	25x25	37.5	25			
99904	25-SX	25x25	37.5	25			

Use Insert L2 Pocket size 13mm or 0.5157" / Ref: Toolholder Size 10 & 12

Broaching and Slotting Inserts - Imperial

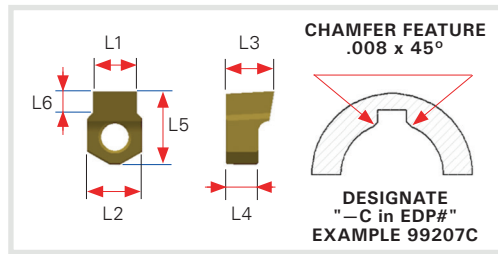

Inserts (inch) - Tolerances															To order a different tolerance - EDP# + (TOLERANCE) = 99202P9	
EDP No.	L1 (Inch)	H-7 (Standard)		P-9		D-10		C-11		L2 (Inch)	L3 (Inch)	L4 (Inch)	L5 (Inch)	L6 (Inch)	Tool Holder Size	Sharpen Stem
		L1 (High)	L1 (Low)	L1 (High)	L1 (Low)	L1 (High)	L1 (Low)	L1 (High)	L1 (Low)							
99202		0.09410	0.09370											0.0551		
99202()	3/32			0.09360	0.09260	0.09610	0.09570	0.09850	0.09810	0.1968	0.2362	0.1968	0.2559	0.0551	2	SS-0
99202C*		0.09410	0.09370											0.0520		
99203		0.12550	0.12551											0.0905		
99203()	1/8			0.12460	0.12340	0.12810	0.12770	0.13070	0.13030	0.2362	0.2755	0.1968	0.3149	0.0905	3	SS-1
99203C*		0.12550	0.12551											0.0740		
99206		0.15670	0.15652											0.1141		
99206()	5/32			0.15590	0.15470	0.15930	0.15892	0.16200	0.16160	0.2362	0.2755	0.1968	0.3149	0.1141	4	SS-1
99206C*		0.15670	0.15652											0.0790		
99207		0.18800	0.18778											0.1299		
99207()	3/16			0.18710	0.18590	0.19060	0.19020	0.19320	0.19280	0.2362	0.2755	0.1968	0.3149	0.1299	5	SS-1
99207C*		0.18800	0.18778											0.1050		
99209		0.25080	0.25040											0.1587		
99209()	1/4			0.24940	0.24800	0.25390	0.25350	0.25670	0.25630	0.3968	0.3543	0.2362	0.5314	0.1587	6	SS-2
99209C*		0.25080	0.25040											0.1360		
99210		0.28180	0.28160											0.1692		
99210()	9/32			0.28060	0.27920	0.28510	0.28470	0.28790	0.28750	0.3968	0.3543	0.2362	0.5314	0.1692	8	SS-2
99210C*		0.28180	0.28160											0.1520		
99212		0.31310	0.31270											0.1875		
99212()	5/16			0.31190	0.31050	0.31640	0.31600	0.31920	0.31880	0.3968	0.3543	0.2362	0.5314	0.1875	8	SS-2
99212C*		0.31310	0.31270											0.1670		
99213		0.37560	0.37520											0.2500		
99213()	3/8			0.37440	0.37300	0.37890	0.37850	0.38170	0.38130	0.5157	0.5511	0.3937	0.7283	0.2500	10	SS-3
99213C*		0.37560	0.37520											0.1990		
99214		0.43820	0.43780											0.2500		
99214()	7/16			0.43680	0.43510	0.44220	0.44180	0.44560	0.44520	0.5157	0.5511	0.3937	0.7283	0.2500	12	SS-4
99214C*		0.43820	0.43780											0.2300		
99215		0.50070	0.50030											0.3000		
99215()	1/2			0.49930	0.49760	0.50470	0.50430	0.50810	0.50760	0.5157	0.5511	0.3937	0.7283	0.3000	12	SS-4
99215C*		0.50070	0.50030											0.2610		
99242		0.56320	0.56280											0.2750		
99242()	9/16			0.56180	0.56010	0.56720	0.56680	0.57060	0.57020	0.7086	0.5511	0.3937	0.8661	0.2750	14/16	SS-4
99242C*		0.56320	0.56280											0.2670		
99216		0.62570	0.62530											0.3120		
99216()	5/8			0.62430	0.62240	0.62970	0.62930	0.63310	0.63270	0.7086	0.5511	0.3937	0.8661	0.3120	14/16	SS-4
99216C*		0.62570	0.62530											0.3024		
99217		0.75080	0.75040											0.3930		
99217()	3/4			0.74910	0.74710	0.75590	0.75550	0.75940	0.75900	1.0236	0.7086	0.3937	1.1811	0.3930	18/26	SS-5
99217C*		0.75080	0.75040											0.3860		
99218		0.87579	0.87559											0.4330		
99218()	7/8			0.8743	0.8738	0.88090	0.88050	0.88450	0.88410	1.0236	0.7086	0.3937	1.1811	0.4330	18/26	SS-5
99218C*		0.87579	0.87559											0.4030		
99219		1.00150	1.00250											0.5410		
99219()	1			0.9993	0.9988	1.00590	1.00550	1.00960	1.00910	1.0236	0.7086	0.3937	1.1811	0.5410	18/26	SS-5
99219C*		1.00150	1.00250													

*Chamfer feature providing a 45° Chamfer at the intersection of the bore and the walls of the broached section when cut to full depth is available by specifying a "C" in the EDP No. for example --- 99408-C.

Broaching and Slotting Inserts - Metric

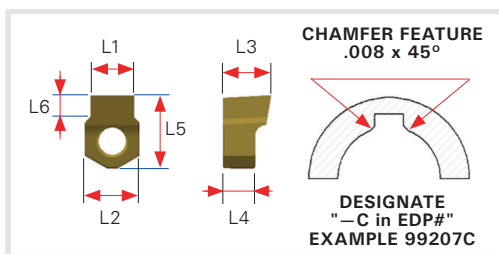

Inserts (mm) - Tolerances				To order a different tolerance - EDP# + (TOLERANCE) = 99202P9												
EDP No.	L1 (mm)	H-7 (Standard)		P-9		D-10		C-11		L2 (mm)	L3 (mm)	L4 (mm)	L5 (mm)	L6 (mm)	Tool Holder Size	Sharpen Stem
		L1 (High)	L1 (Low)	L1 (High)	L1 (Low)	L1 (High)	L1 (Low)	L1 (High)	L1 (Low)							
99401	2	0.07910	0.07810							5.00	6.50	5.00	6.00	1.30	2	SS-0
99401()				0.07850	0.07750	0.08540	0.08110	0.08350	0.08300					1.30		
99401C*		0.07910	0.07810											1.09		
99402	3	0.11860	0.11830							6.08	6.50	5.00	7.50	2.00	3	SS-1
99402()				0.11790	0.11690	0.12090	0.12047	0.12280	0.12244					2.00		
99402C*		0.11860	0.11830											1.42		
99403	4	0.15800	0.15767							6.08	7.00	5.00	8.00	2.60	4	SS-1
99403()				0.15710	0.15590	0.16020	0.15984	0.16220	0.16180					2.60		
99403C*		0.15800	0.15767											2.07		
99404	5	0.19730	0.19705							6.08	7.00	5.00	8.00	3.00	5	SS-1
99404()				0.19650	0.19530	0.19960	0.19920	0.20160	0.20118					3.00		
99404C*		0.19730	0.19705											2.74		
99406	6	0.23680	0.23650							10.08	9.00	6.00	13.50	4.00	6	SS-2
99406()				0.23560	0.23420	0.23940	0.23897	0.24090	0.24055					4.00		
99406C*		0.23680	0.23650											3.00		
99407	8	0.31560	0.31527							10.08	9.00	6.00	13.50	4.50	8	SS-2
99407()				0.31440	0.31300	0.31810	0.31770	0.32050	0.32010					4.50		
99407C*		0.31560	0.31527											3.78		
99408	10	0.39430	0.39410							13.10	14.00	10.00	18.50	6.00	10	SS-3
99408()				0.39300	0.39130	0.39720	0.39680	0.40000	0.39960					6.00		
99408C*		0.39430	0.39410											3.88		
99409	12	0.47310	0.47280							13.10	14.00	10.00	18.50	6.50	12	SS-3
99409()				0.47170	0.47000	0.47600	0.47560	0.47950	0.47910					6.50		
99409C*		0.47310	0.47280											3.89		
99410	14	0.55190	0.55157							18.00	14.00	10.00	22.00	7.00	14/16	SS-4
99410()				0.55050	0.54880	0.55510	0.55472	0.55910	0.55860					7.00		
99410C*		0.55190	0.55157											4.71		
99411	16	0.63060	0.63030							18.00	14.00	10.00	22.00	8.00	14/16	SS-4
99411()				0.62920	0.62750	0.63390	0.63346	0.63780	0.63740					8.00		
99411C*		0.63060	0.63030											5.53		
99412	18	0.70950	0.70905							26.00	18.00	10.00	30.00	9.00	18/26	SS-5
99412()				0.70780	0.70580	0.71450	0.71413	0.71810	0.71770					9.00		
99412C*		0.70950	0.70905											5.67		
99413	20	0.78820	0.78780							26.00	18.00	10.00	30.00	10.00	18/26	SS-5
99413()				0.78650	0.78450	0.79330	0.79287	0.79690	0.79645					10.00		
99413C*		0.78820	0.78780											6.29		
99414	22	0.86700	0.86650							26.00	18.00	10.00	30.00	11.00	18/26	SS-5
99414()				0.86520	0.86320	0.87200	0.87160	0.87560	0.87519					11.00		
99414C*		0.86700	0.86650											6.79		
99494	25	0.98510	0.98464							26.00	18.00	10.00	30.00	12.00	18/26	SS-5
99494()				0.98340	0.98140	0.99010	0.98970	0.99370	0.99330					12.00		
99494C*		0.98510	0.98464											7.02		

*Chamfer feature providing a 45° Chamfer at the intersection of the bore and the walls of the broached section when cut to full depth is available by specifying a "C" in the EDP No. for example --- 99402-C.

The Inserts designed to work exclusively with duMONT Tool Holders are a sintered steel alloy with a 13% cobalt content, heat treated to a 72 HRC hardness providing toughness and impact resistance. A TiN coating is applied to improve wear resistance and lubricity. All Inserts are designed to allow several re-sharpenings. Stock Insert specifications and mild steel application data are provided. A Chamfer Feature is available (see footnote*). See the Engineering Section for process and Special Insert information and available applications — Keyways in Tapered Bore, Square, Hexagon and Involute Internal Gears. We can add custom corner radius per your requirement, allow up to 2 weeks for modification and recoating.

MAX HP Inserts

The MAX HP Inserts are optimal for use in stainless, super alloys, and hardened steel applications. Higher rake angle; TiAlN coated

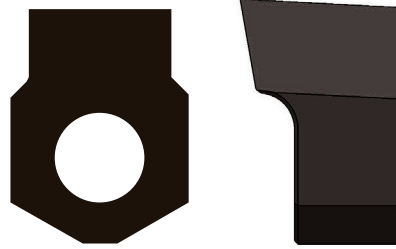
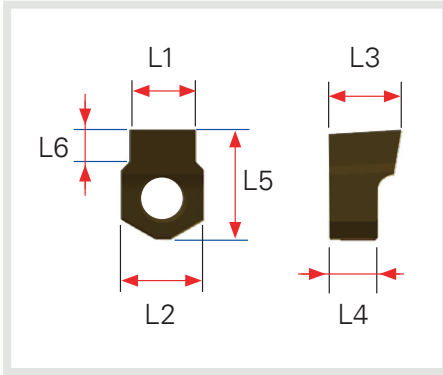

New for 2022

**Designed for
Hi-Temp, Stainless
& Hardened Steel
Alloys**

Inserts (inch) - Tolerances

EDP No.	L1 (Inch)	H-7 (Standard)		L2 (Inch)	L3 (Inch)	L4 (Inch)	L5 (Inch)	L6 (Inch)	Tool Holder Size	Sharpen Stem
		L1 (High)	L1 (Low)							
99202 -M	3/32	0.09410	0.09370	0.1968	0.2362	0.1968	0.2559	0.0551	2	SS-0
99203 -M	1/8	0.12550	0.12551	0.2362	0.2755	0.1968	0.3149	0.0905	3	SS-1
99206 -M	5/32	0.15670	0.15652	0.2362	0.2755	0.1968	0.3149	0.1141	4	SS-1
99207 -M	3/16	0.18800	0.18778	0.2362	0.2755	0.1968	0.3149	0.1299	5	SS-1
99209 -M	1/4	0.25080	0.25040	0.3968	0.3543	0.2362	0.5314	0.1587	6	SS-2
99210 -M	9/32	0.28180	0.28160	0.3968	0.3543	0.2362	0.5314	0.1692	8	SS-2
99212 -M	5/16	0.31310	0.31270	0.3968	0.3543	0.2362	0.5314	0.1875	8	SS-2
99213 -M	3/8	0.37560	0.37520	0.5157	0.5511	0.3937	0.7283	0.2500	10	SS-3
99214 -M	7/16	0.43820	0.43780	0.5157	0.5511	0.3937	0.7283	0.2500	12	SS-4
99215 -M	1/2	0.50070	0.50030	0.5157	0.5511	0.3937	0.7283	0.3000	12	SS-4
99242 -M	9/16	0.56320	0.56280	0.7086	0.5511	0.3937	0.8661	0.2750	14/16	SS-4
99216 -M	5/8	0.62570	0.62530	0.7086	0.5511	0.3937	0.8661	0.3120	14/16	SS-4
99217 -M	3/4	0.75080	0.75040	1.0236	0.7086	0.3937	1.1811	0.3930	18/26	SS-5
99218 -M	7/8	0.87579	0.87559	1.0236	0.7086	0.3937	1.1811	0.4330	18/26	SS-5
99219 -M	1	1.00150	1.00250	1.0236	0.7086	0.3937	1.1811	0.5410	18/26	SS-5

Inserts (mm) - Tolerances

EDP No.	L1 (mm)	H-7 (Standard)		L2 (mm)	L3 (mm)	L4 (mm)	L5 (mm)	L6 (mm)	Tool Holder Size	Sharpen Stem
		L1 (High)	L1 (Low)							
99401 -M	2	0.07910	0.07810	5.00	6.50	5.00	6.00	1.30	2	SS-0
99402 -M	3	0.11860	0.11830	6.08	6.50	5.00	7.50	2.00	3	SS-1
99403 -M	4	0.15800	0.15767	6.08	7.00	5.00	8.00	2.60	4	SS-1
99404 -M	5	0.19730	0.19705	6.08	7.00	5.00	8.00	3.00	5	SS-1
99406 -M	6	0.23680	0.23650	10.08	9.00	6.00	13.50	4.00	6	SS-2
99407 -M	8	0.31560	0.31527	10.08	9.00	6.00	13.50	4.50	8	SS-2
99408 -M	10	0.39430	0.39410	13.10	14.00	10.00	18.50	6.00	10	SS-3
99409 -M	12	0.47310	0.47280	13.10	14.00	10.00	18.50	6.50	12	SS-3
99410 -M	14	0.55190	0.55157	18.00	14.00	10.00	22.00	7.00	14/16	SS-4
99411 -M	16	0.63060	0.63030	18.00	14.00	10.00	22.00	8.00	14/16	SS-4
99412 -M	18	0.70950	0.70905	26.00	18.00	10.00	30.00	9.00	18/26	SS-5
99413 -M	20	0.78820	0.78780	26.00	18.00	10.00	30.00	10.00	18/26	SS-5
99414 -M	22	0.86700	0.86650	26.00	18.00	10.00	30.00	11.00	18/26	SS-5
99494 -M	25	0.98510	0.98464	26.00	18.00	10.00	30.00	12.00	18/26	SS-5

Tools for Splined Profiles

The SP tool line was designed to make splined internal profiles. The choice of tool is determined by the minimum entry hole of the workpiece to be machined. In fact, we recommend purchasing a tool with a diameter (D2) as close to the value of said hole as possible, as shown in the table. It is also possible to make special tools in various diameters and sizes based on specific customer needs.

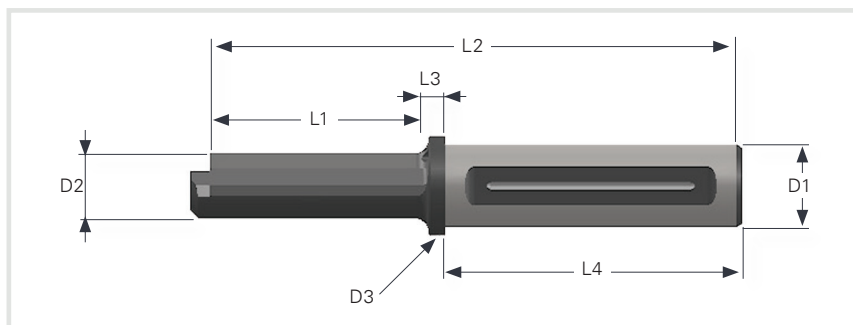
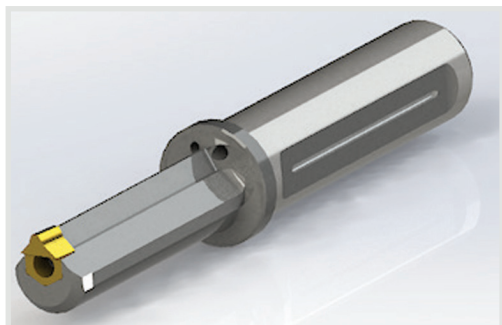
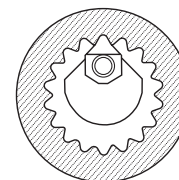

Tools for Splined Profiles (mm)													
EDP No.	Description	L1 (mm)	L2 (mm)	L3 (mm)	L4 (mm)	D1 (mm)	D2 (mm)	D3 (mm)	Centering Plate	Torx driver	Mounting screw	Minimum hole (mm)	Weight (g)
99801	02-25	25.0	124.0	9.0	90.0	25.0	6.5	30.0	CP-0	T08	MS-1	7.0	382
99802	02-32	25.0	134.0		100.0	32.0	6.5	37.0	CP-0	T08	MS-1	7.0	600
99803	03-25	30.0	129.0		90.0	25.0	8.0	30.0	CP-1	T08	MS-1	8.5	368
99804	03-32	30.0	139.0		100.0	32.0	8.0	37.0	CP-1	T08	MS-1	8.5	673
99805	04-25	40.0	139.0		90.0	25.0	10.0	30.0	CP-1	T08	MS-1	10.5	368
99806	04-32	40.0	149.0		100.0	32.0	10.0	37.0	CP-1	T08	MS-1	10.5	672
99807	05-25	46.0	145.0		90.0	25.0	12.0	30.0	CP-1	T08	MS-1	12.5	382
99808	05-32	46.0	155.0		100.0	32.0	12.0	37.0	CP-1	T08	MS-1	12.5	698
99809	06-25	56.0	155.0		90.0	25.0	16.0	30.0	CP-2	T15	MS-2	16.5	428
99810	06-32	56.0	165.0		100.0	32.0	16.0	37.0	CP-2	T15	MS-2	16.5	725
99811	08-25	68.0	162.0		90.0	25.0	20.0	30.0	CP-2	T15	MS-2	21.0	488
99812	08-32	68.0	172.0		100.0	32.0	20.0	37.0	CP-2	T15	MS-2	21.0	820
99813	10-25	86.0	185.0		90.0	25.0	25.0	30.0	CP-3	T20	MS-3	28.0	647
99814	10-32	86.0	195.0		100.0	32.0	25.0	37.0	CP-3	T20	MS-3	28.0	935
99815	12-25	102.0	203.0		90.0	25.0	30.0	30.0	CP-3	T20	MS-3	33.0	824
99816	12-32	102.0	213.0		100.0	32.0	30.0	37.0	CP-3	T20	MS-3	33.0	1,157
99817	14/16-25	126.0	221.0		90.0	25.0	35.0	37.0	CP-4	T20	MS-3	38.0	1,211
99818	14/16-32	126.0	231.0		100.0	32.0	35.0	37.0	CP-4	T20	MS-3	38.0	1,490
99819	18/25-32	140.0	249.0	100.0	32.0	40.0	45.0	CP-5	BRUG.5	MS-4	42.0	1,903	

Note: Inserts used on the tool line for splined profiles are all considered special: they are not in stock; rather, they are manufactured specifically for the customer based on the type of machining required. Please contact us for a quote.

Tools and Inserts for Square

This series of duMONT tools was developed to execute internal squares. It offers the following advantages: absolute concentricity, the possibility of correcting the required measurement, machining speed and cost savings. Every insert size in this line is able to execute various square sizes, which makes using duMONT tools for squares very economical and convenient. To execute internal square holes, it is necessary to cut a pre-hole with a diameter based on the following formula:

$$\text{PRE-HOLE DIAMETER} = \text{SQUARE THICKNESS} \times 1.050$$

For example, for a square with a thickness of 10mm, the diameter of the pre-hole will be: 10mm x 1.050 = 10.50mm

To execute completely square holes, the customer will need to make a specific request and will be supplied with an ad hoc tool. In addition to this, in many other cases, in order to obtain a perfectly appropriate tool for the type of square hole that needs to be executed, it will be possible to produce a special tool that meets the customer's specifications.

Tools for Square

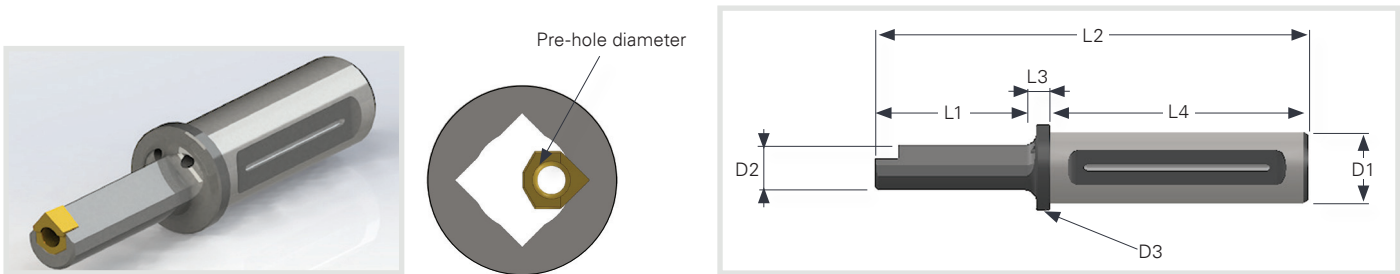

Tools for Square (mm)													
EDP No.	Description	L1 (mm)	L2 (mm)	L3 (mm)	L4 (mm)	D1 (mm)	D2 (mm)	D3 (mm)	Centering Plate	Torx driver	Mounting screw	Minimum hole (mm)	Weight (g)
99621	8/10-25	30.0	129.0	9.0	90.0	25.0	7.25	30.0	CP-1	T08	MS-1	8.0	368
99622	8/10-32	30.0	139.0		100.0	32.0	7.25	37.0	CP-1	T08	MS-1	8.0	673
99623	10/13-25	40.0	139.0		90.0	25.0	8.60	30.0	CP-1	T08	MS-1	10.0	368
99624	10/13-32	40.0	149.0		100.0	32.0	8.60	37.0	CP-1	T08	MS-1	10.0	672
99625	13/16-25	50.0	149.0		90.0	25.0	12.00	30.0	CP-2	T15	MS-2	13.0	428
99626	13/16-32	50.0	159.0		100.0	32.0	12.00	37.0	CP-2	T15	MS-2	13.0	725
99627	16/19-25	52.0	151.0		90.0	25.0	15.00	30.0	CP-3	T20	MS-3	16.0	647
99628	16/19-32	52.0	161.0		100.0	32.0	15.00	37.0	CP-3	T20	MS-3	16.0	935
99629	19/27-25	86.0	185.0		90.0	25.0	18.50	30.0	CP-3	T20	MS-3	19.0	824
99630	19/27-32	86.0	195.0		100.0	32.0	18.50	37.0	CP-3	T20	MS-3	19.0	1,157
99631	27/37-25	100.0	199.0		90.0	25.0	25.00	30.0	CP-4	T20	MS-3	27.0	1,390
99632	27/37-32	100.0	209.0		100.0	32.0	25.00	37.0	CP-4	T20	MS-3	27.0	1,490
99633	37/50-32	140.0	249.0		100.0	32.0	35.00	45.0	CP-5	BRUG-5	MS-4	37.0	1,903

Inserts for Square

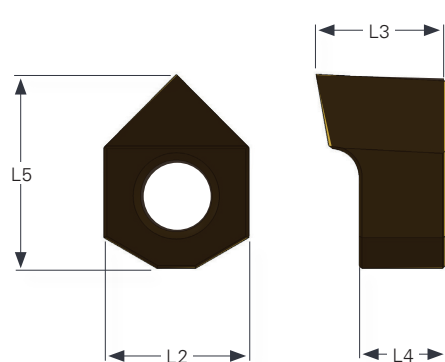

NEW for 2022

Inserts for Square (mm)									
TIN EDP No.	MAX HP Inserts	Working range (mm)	Working range (inches)	L2 (mm)	L3 (mm)	L4 (mm)	L5 (mm)	Tool Holder Size	Sharpen Stem
99601	99601-M	8mm/10mm	0.314/0.393	6.00	7.00	5.00	7.00	8/10	SS-1
99602	99602-M	10mm/13mm	0.393/0.511	6.00	7.00	5.00	7.50	10/13	SS-1
99603	99603-M	13mm/16mm	0.511/0.629	10.00	8.00	6.00	12.00	13/16	SS-2
99604	99604-M	16mm/19mm	0.629/0.748	10.00	8.00	6.00	12.50	16/19	SS-2
99605	99605-M	19mm/27mm	0.748/1.062	13.00	13.00	10.00	17.00	19/27	SS-3
99606	99606-M	27mm/37mm	1.062/1.456	18.00	14.00	10.00	22.00	27/37	SS-4
99607	99607-M	37mm/50mm	1.456/1.968	26.00	18.00	10.00	30.00	37/50	SS-5

*Reference Radius Chart on pg. 61

Tools and Inserts for Hexagon

The duMONT CNC Indexable Broaching System was developed to execute internal hexagons. It offers the following advantages: absolute concentricity, the possibility of correcting the required measurement, machining speed and cost savings. Every insert size in this line is able to execute various hexagonal sizes, which makes using duMONT tools for hexagons very economical and convenient. To execute internal hexagonal holes, it is necessary to cut a pre-hole with a diameter based on the following formula:

$$\text{PRE-HOLE DIAMETER} = \text{HEXAGON THICKNESS} \times 1.020$$

For example, for a hexagon with a thickness of 10mm, the diameter of the pre-hole will be: 10mm x 1.020 = 10.20mm

To achieve your desired hexagonal hole, contact our Engineering Department for a custom solution to meet your needs.

Tools for Hexagon

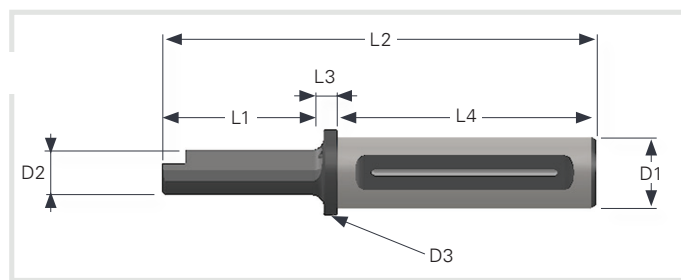
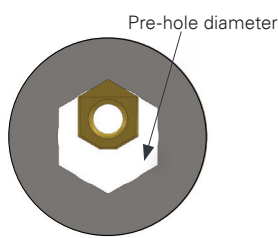
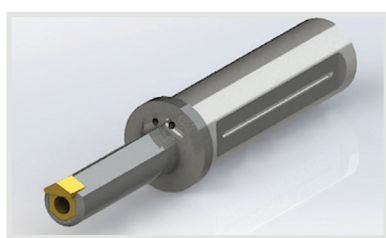

Tools for Hexagon (mm)													
EDP No.	Description	L1 (mm)	L2 (mm)	L3 (mm)	L4 (mm)	D1 (mm)	D2 (mm)	D3 (mm)	Centering Plate	Torx driver	Mounting screw	Minimum hole (mm)	Weight (g)
99721	9/11-25	30.0	129.0	9.0	90.0	25.0	8.0	30.0	CP-1	T08	MS-1	9.0	388
99722	9/11-32	30.0	139.0		100.0	32.0	8.0	37.0	CP-1	T08	MS-1	9.0	673
99723	11/17-25	40.0	139.0		90.0	25.0	10.0	30.0	CP-1	T08	MS-1	11.0	368
99724	11/17-32	40.0	149.0		100.0	32.0	10.0	37.0	CP-1	T08	MS-1	11.0	672
99725	17/28-25	56.0	155.0		90.0	25.0	15.0	30.0	CP-2	T15	MS-2	17.0	647
99726	17/28-32	56.0	165.0		100.0	32.0	15.0	37.0	CP-2	T15	MS-2	17.0	935
99727	28/37-25	86.0	185.0		90.0	25.0	25.0	30.0	CP-3	T20	MS-3	28.0	1,390
99728	28/37-32	86.0	195.0		100.0	32.0	25.0	37.0	CP-3	T20	MS-3	28.0	1,157
99729	37/45-25	126.0	225.0		90.0	25.0	35.0	45.0	CP-4	T20	MS-3	37.0	1,490
99730	37/45-32	126.0	235.0		100.0	32.0	35.0	45.0	CP-4	T20	MS-3	37.0	1,850
99731	45/70-32	140.0	249.0	100.0	32.0	40.0	45.0	CP-5	BRUG 5	MS-4	45.0	1,950	

Inserts for Hexagon

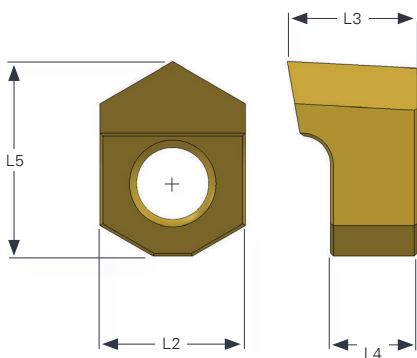

NEW for 2022

Inserts for Hexagon (mm)										
TIN EDP No.	MAX HP Inserts	Working range (mm)	Working range (inches)	L2 (mm)	L3 (mm)	L4 (mm)	L5 (mm)	Tool Holder Size	Sharpen Stem	
99701	99701-M	9mm/11mm	0.354/0.433	6.00	7.00	5.00	7.50	9/11	SS-1	
99702	99702-M	11mm/17mm	0.433/0.669	6.00	7.00	5.00	8.00	11/17	SS-1	
99703	99703-M	17mm/28mm	0.669/1.102	10.00	9.00	6.00	13.50	17/28	SS-2	
99704	99704-M	28mm/37mm	1.102/1.456	13.00	14.00	10.00	18.50	28/37	SS-3	
99705	99705-M	37mm/45mm	1.456/1.771	18.00	14.00	10.00	22.00	37/45	SS-4	
99706	99706-M	45mm/70mm	1.771/2.755	26.00	16.00	10.00	30.00	45/70	SS-5	

*Reference Radius Chart on pg. 61

Charging Handle for CNC Broaching Kit

Charging Handle Broach

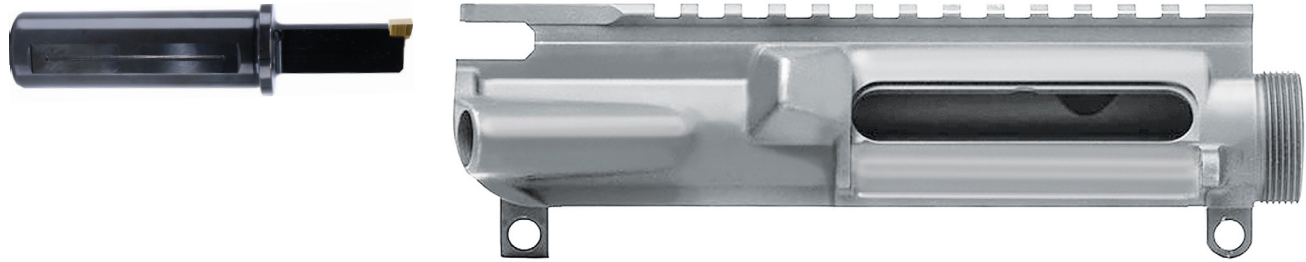

For improved functionality of charging handles, use our CNC Charging Handle Broaching Kit.

Key features and benefits include:

- Broach is internal to machine cycle
- No subcontractor/offline operation required
- Easy resharpening of insert (up to 3-5 times)
- Costs only 25% of traditional broaching

The Charging Handle CNC Broaching Kit is available for:

AR15 (.223/5.56 NATO)

AR10 (.308/.762)

AR22 (.22 LR)

AR9 (9mm)

Cutting Data includes:

300-500 IPM

.0035 CPP (cut per pass)



Estimated Cycle Time:
45 seconds

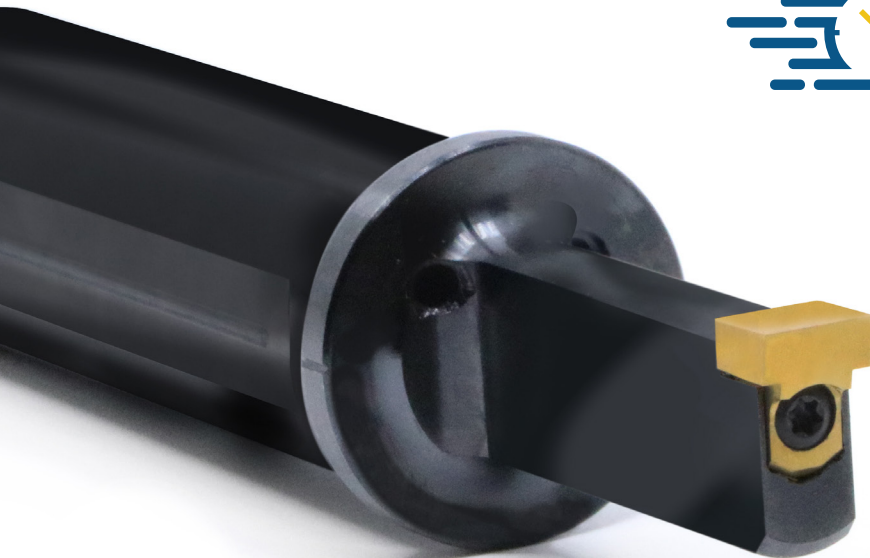

Charging Handle Kit

EDP 99914

(Comes with 4 inserts & mounting screws,
1 holder & torx driver)

Replacement Components

99925 AR Charging Handle Insert

99926 AR Charging Handle Holder

99562 T-15 Torx Driver

99552 MS-2 Mounting Screw

Inserts can be modified if needed.

AR Firearm CNC Broaching Kits

The **duMONT CNC AR15/M16 Magwell Kit** comes with 3 holders, 3 types of inserts, 2 drivers, and an alignment tool in a durable case. This kit allows all broaching of a magwell to be done within the CNC cycle. The need for a secondary broaching process in a special purpose broaching machine is eliminated!



**Insert 1
Profile Insert**

**Insert 2
Long Straight Insert**

**Insert 3
Mag Catch Insert**



**Save time: Approximate
1 minute 30 sec. total
broaching cycle time**

1-1/4" Shank Diameter Holders

CUTTING DATA

300-500 IPM with
.0035 stepover

ROUGHMILL
(with a $\phi 3/8"$ endmill)
then 51 passes
OR

ROUGHMILL
(with a $\phi 1/2"$ endmill)
then 69 passes

3 passes at final depth

Estimated Tool Life,
2,600 pieces TiN coated
EDP 99911 for AR10
EDP 99916 for AR15
Can be Resharpended
2-3 times

300-500 IPM with
.0035 stepover

ROUGHMILL
(with a $\phi 3/8"$ endmill)
then 45 passes
OR

ROUGHMILL
(with a $\phi 1/2"$ endmill)
then 63 passes

3 passes at final depth

Estimated Tool Life,
2,600 pieces TiN coated
EDP 99912 for AR10
EDP 99917 for AR15
Can be Resharpended
2-3 times

300-400 IPM with
.0025-.0055 stepover

ROUGHMILL
(with a $\phi 3/8"$ or $\phi 1/2"$ endmill)
then 15 passes

3 passes at final depth

Estimated Tool Life,
4,000 pieces TiN coated
EDP 99918 for AR10 & AR15
Can be Resharpended
2-3 times

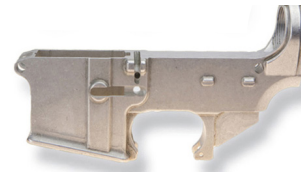
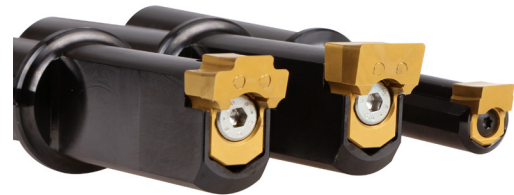

A standard CNC broaching tool can be added if you would like to make the magazine reliefs square corners.



AR15/M16 and AR10 FIREARMS KIT

99910 AR10 Magwell Kit

99915 AR15 Magwell Kit

Kit Components

EDP No.	Description
99910	AR10 Mag Well Kit
99911	AR10 INSERT 1 (PROFILE)
99912	AR10 INSERT 2
99915	AR15 MAGWELL KIT
99916	AR15 INSERT 1 (PROFILE)
99917	AR15 INSERT 2 (STRAIGHT)
99918	AR15 & AR10 INSERT 3 (MAG CATCH)
99921	AR15 & AR10 HOLDER 1 (TAKES INSERT 1 & 2)
99922	AR15 & AR10 HOLDER 2 (MAG CATCH)

1911 CNC Broaching Kit

Insertable tool vs. solid tool or round tool

1911 Broaching Kit

EDP Nos.	
99927	1911 Broaching Kit

Complete Pistol Kits

The 1911 CNC Broaching Kit is available for:

.45 ACP	.22 LR
40 S&W	10mm
.380 ACP	9mm

Components: 1 of each / kit

EDP Nos.	
99928	1911 Magwell Insert
99929	1911 Magwell Holder
99930	1911 Trigger Slot Insert
99931	1911 Trigger Slot Holder
99932	1911 Trigger Bow Insert
99933	1911 Trigger BowHolder
99561	T-08 Torx Driver
99562	T-15 Torx Driver



Trigger Bow Tool
Insert cut width -
0.235" / 5.9817 mm

Trigger Slot Tool
Insert cut width -
0.252" / 6.4008 mm

Magwell Tool
Insert cut width -
0.556" / 14.1224 mm

Inserts can be Custom Made to order



Stock Eccentric Bushings

The Eccentric Bushings are designed to allow the use of the Tool Holders in lathes that do not have a Y-axis. The Bushing, manufactured from tool steel, hardened and ground, enables symmetry corrections within a range of +Y 0.5mm (.020 inch) to -Y 0.5mm (.020 inch). The Eccentric Bushings can accommodate Tool Holders with either 25mm or 32mm shanks and are available in various diameters, allowing the Tooling System to be used in a wide variety of machines. Shorter VDI style Eccentric bushings are also available.

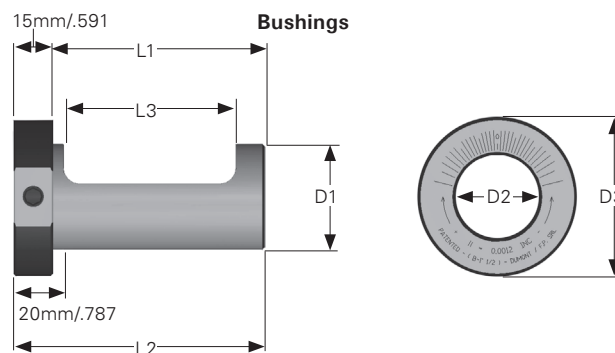

Stock Eccentric Bushings for use with 25mm (.984 inch) and 32mm (1.260 inch) Tool Holders													
EDP No.	Description	Shank Diameter (D1)		Shank Internal Dia.(D2)		Shank Length (L1)		Overall Length (L2)		Collar Diameter (D3)		Undercut Length (L2)	
		(mm)	(inch)	(mm)	(inch)	(mm)	(inch)	(mm)	(inch)	(mm)	(inch)	(mm)	(inch)
99060	EB-1-1/4	31.8	1.250	25	0.984	70	2.756	85	3.346	55	2.165	58	2.283
99061	EB-1-1/2	38.1	1.500	32	1.260	80	3.150	95	3.740	55	2.165	66	2.598
99062	EB-2	50.8	2.000	32	1.260	100	3.937	115	4.528	65	2.559	75	2.953
99063	EB-32	32	1.260	25	0.984	70	2.756	85	3.346	55	2.165	58	2.283
99064	EB-40	40	1.575	32	1.260	80	3.150	95	3.740	55	2.165	66	2.598
99065	EB-50	50	1.969	32	1.260	100	3.937	115	4.528	65	2.559	75	2.953
99066	EB-60	60	2.362	32	1.260	100	3.937	115	4.528	80	3.150	75	2.953
99070	EB-1-1/4-VDI	31.8	1.250	25	0.984	50	1.969	65	2.559	55	2.165	38	1.496
99071	EB-1-1/2-VDI	38.1	1.500	32	1.260	65	2.559	80	3.150	55	2.165	51	2.008
99072	EB-2-VDI	50.8	2.000	32	1.260	80	3.150	95	3.740	65	2.559	55	2.168
99073	EB-32-VDI	32	1.260	25	0.984	50	1.969	65	2.559	55	2.165	38	1.496
99074	EB-40-VDI	40	1.575	32	1.260	65	2.559	80	3.150	55	2.165	51	2.008
99075	EB-50-VDI	50	1.969	32	1.260	80	3.150	95	3.740	65	2.559	55	2.165
99076	EB-60-VDI	60	2.362	32	1.260	80	3.150	95	3.740	80	3.150	55	2.165

Stock Square Adaptors

The Square Adaptors are available in two sizes for use with either 25mm or 32mm Tool Holders. The Adaptors provide a method for allowing the Tooling System to be used on traditional machines such as Slotting and Shaping machines. Manufactured from 39NiCrMo3 steel, heat treated and then blued, the Adaptor provides two holes 12 MA threaded for use with two flat head M12 x 8 screws to secure the Tool Holder in place. The Square Adaptor offers a locating slot on each of the four sides.

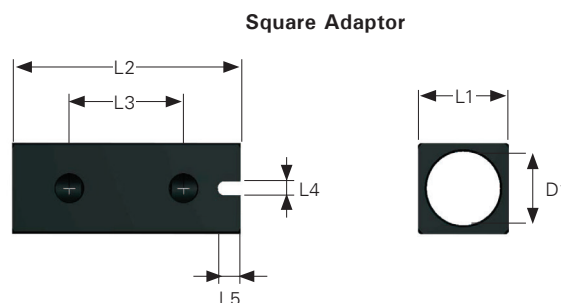

Stock Square Adaptors													
EDP No.	Description	Shank Diameter (D1)		Width & Height (L1)		Overall Length (L2)		Locking Bolt Holes (L3)		Locating Slot Width (L4)		Locating Slot Depth (L5)	
		(mm)	(inch)	(mm)	(inch)	(mm)	(inch)	(mm)	(inch)	(mm)	(inch)	(mm)	(inch)
99535	SA-35	25	.984	35	1.387	90	3.543	40	1.575	6	.236	10	0.394
99540	SA-40	32	1.260	40	1.575	100	3.937	50	1.969	6	.236	10	0.394
99550	SA-50	32	1.260	50	1.969	170	6.693	50	1.969	6	.236	10	0.394

Stock Centering Plates

The Centering Plates are designed to fit specific Tool Holders and facilitate correct mounting and orientation of the Tool Holder. The Centering Plate sits in the Tool Holder, as does the Insert, and provides a surface to be referenced using a sensor or gauge.

The results are used to reference against the axis of the part to be processed. The chart below identifies the Tool Holders that can be used with a particular Centering Plate.

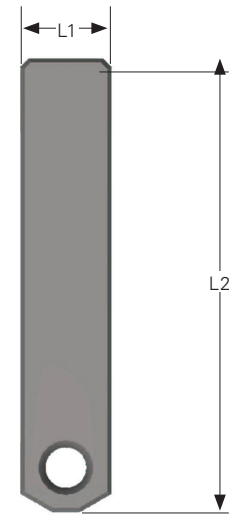

Stock Centering Plates						
EDP No.	Description	Used with tool holders size	Plate Height (L1)		Plate Height (L2)	
			(mm)	(inch)	(mm)	inch
99500	CP-0	2	5	0.197	50	1.968
99501	CP-1	3, 4 & 5	6	0.236	50	1.969
99502	CP-2	6 & 8	10	0.394	50	1.969
99503	CP-3	10 & 12	13	0.512	60	2.362
99504	CP-4	14/16	18	0.709	70	2.756
99505	CP-5	18/26	26	1.024	70	2.756

Stock Sharpening Stems

Insert life can be extended through re-sharpening of Inserts that show a decline in surface finish (a sign of wear). The Sharpening Stems, available in 5 sizes, are designed to accept specific Insert sizes. The Insert is removed from the Tool Holder and mounted on the Sharpening Stem. The Sharpening Stem holds the Insert securely in place as the cutting edge of the Insert is sharpened at its original angle using a suitable grinder and grinding wheel.

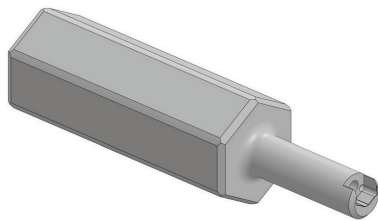

Stock Sharpening Stems					
EDP No.	Description	Used with insert (inch)	Used with insert (mm)	Overall Length	
				(mm)	(inch)
99520	SS-0	3/32	2	150	5.906
99521	SS-1	1/8, 5/32 & 3/16	3, 4 & 5		
99522	SS-2	1/4, 9/32 & 5/16	6 & 8		
99523	SS-3	3/8	10 & 12		
99524	SS-4	7/16 – 5/8	14 & 16		
99525	SS-5	3/4-1	18 – 26		

Insert Mounting Screws and Torx Drivers

Inserts are mounted in the Tool Holder using a Torx Screw or 5mm Hex screw. The Screw size varies with the size of the Tool Holder. Replacement and extra Screws are available as are the appropriate size Torx Drivers. The charts on the right lists the individual Screw and Driver sizes and the Tool Holders they are used with.

Stock Insert Mounting Screws and Torx Driver				
EDP No.	Description	Style	Thread	Used with tool holders size
99551	MS-1	Torx	M 2.5 x .45	2, 3, 4 & 5
99552	MS-2	Torx	M 4 x .70	6 & 8
99553	MS-3	Torx	M 6 x 1.00	10, 12 & 14/16
99554	MS-4	5mm Hex	M 8 x 1.25	18/26

Torx Drivers			
EDP No.	Description	Style	Used with tool holders size
99561	T-08	Torx	2, 3, 4 & 5
99562	T-15	Torx	6 & 8
99563	T-20	Torx	10, 12 & 14/16
99564	5mm	Hex Driver	18/26

Stock Swivel Ball-Bearing Point Set Screws

Used in Lathe Without Y-axis

The Set Screws are used only in Lathe without Y-axis during Eccentric Bushing rotation to correct symmetry errors. Do not over-tighten Ball-Bearing Point Set Screw. It must allow the Tool Holder to move up and down as the Bushing is rotated. It is important to confirm the bolt requirements for the existing tooling to be used in the mounting of the Tooling System.

Stock Swivel Ball-Bearing Point Set Screws			
EDP No.	Description	Thread	Length
99571	BB-1	M 6 x 1.00	15mm
99572	BB-2	M 8 x 1.25	18mm
99573	BB-3	M 10 x 1.5	23mm
99574	BB-4	M 12 x 1.75	26mm
99575	BB-5	M 14 x 2.00	30mm
99576	BB-6	M 16 x 2.00	33mm
99577	BB-7	UNC 5/16-18	37/64
99578	BB-8	UNC 3/8-16	5/8
99579	BB-9	UNC 1/2-13	3/4
99580	BB-10	UNC 5/8-11	36/64



Motorized Slotter

FASTER CNC Broaching with Optimal Performance

The duMONT Motorized Slotter can easily handle internal and external keyway and spline profiles in significantly shorter cycle times while consolidating operations in one machine and eliminating secondary broaching operations.

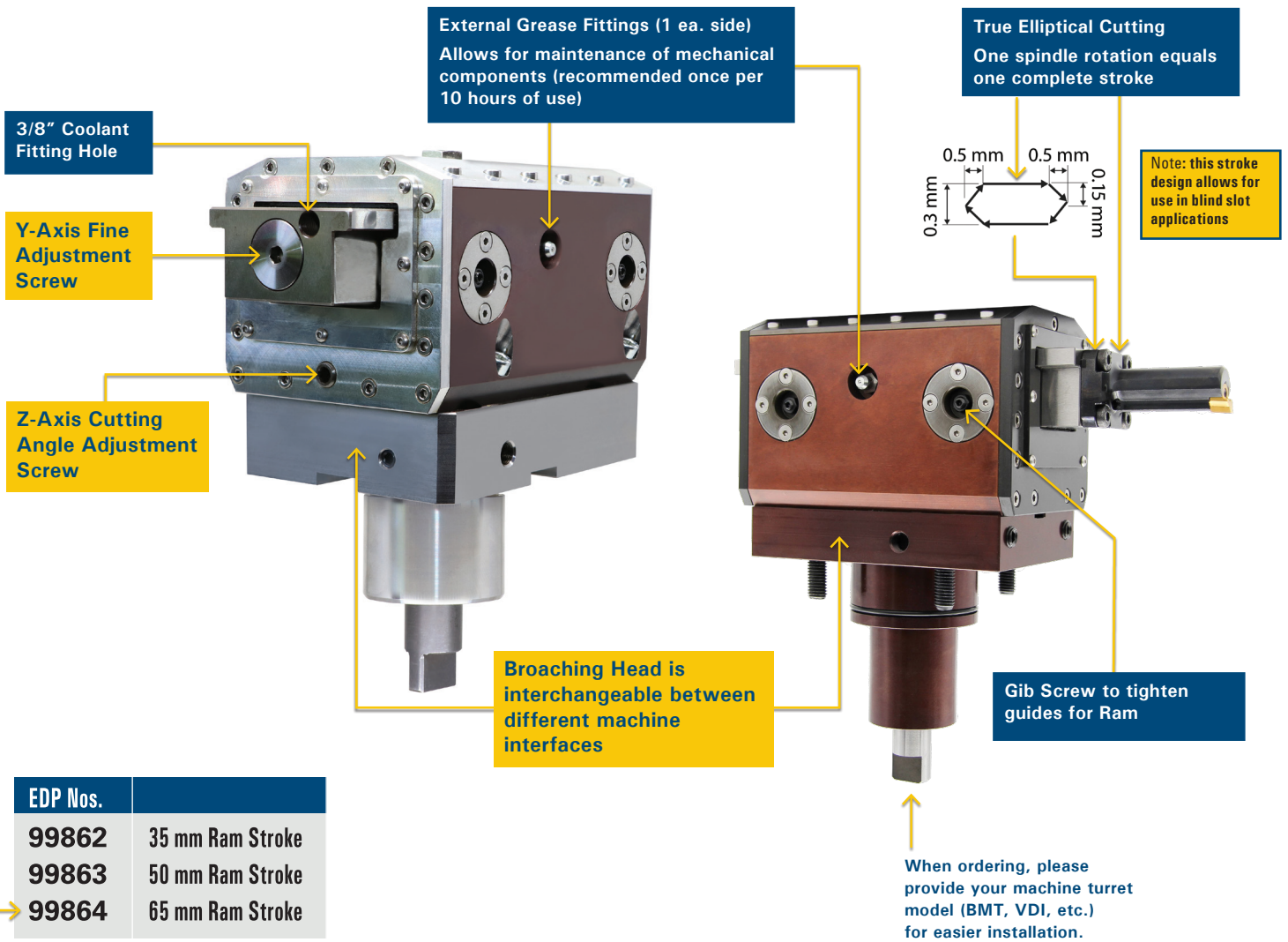

EDP Nos.	
99862	35 mm Ram Stroke
99863	50 mm Ram Stroke
99864	65 mm Ram Stroke

Key Features & Benefits

- 6 Sided Ram Design creates maximum torsional rigidity resulting in superior finish, tool life, and **allows for a longer 65 mm Stroke option**
- Great for shaping holes into hex or squares 1" or larger beyond rotary broaching limits
- Easy to maintain and rebuild based on the ability to grease/lubricate
- Rebuild* Kit is available for bearings and seals for DIY maintenance, or the unit can be sent back for maintenance at **Half the Cost of Competitors**

Cycle Time Comparison:

5-10x FASTER than other CNC Broaching Tools for OD & ID Slots & Splines	50x FASTER than Wire EDM in Slots or Splines
--	---

*12 Month Warranty on Product Defects

duMONT CNC Slotter DIY Kit

Easy Rebuild for Faster CNC Broaching

To keep your Motorized Slotter working at maximum efficiency, we give you the option of using our DIY Rebuild Kit or send us your equipment to repair at our facility. *General recommendation is to rebuild after 1000 continuous cycle hours.



EDP Nos.	Rebuild Kit
99865	35 mm Ram Stroke
99866	50 mm Ram Stroke
99867	65 mm Ram Stroke
Rebuild	Pilot Standard Rebuild <i>*Average: 2 Weeks</i>

Contact us for Quote on 48 hour Expedited Rebuild.

Price will vary depending on amount of work required.

**Loaner Heads available for Emergency Repairs only.*

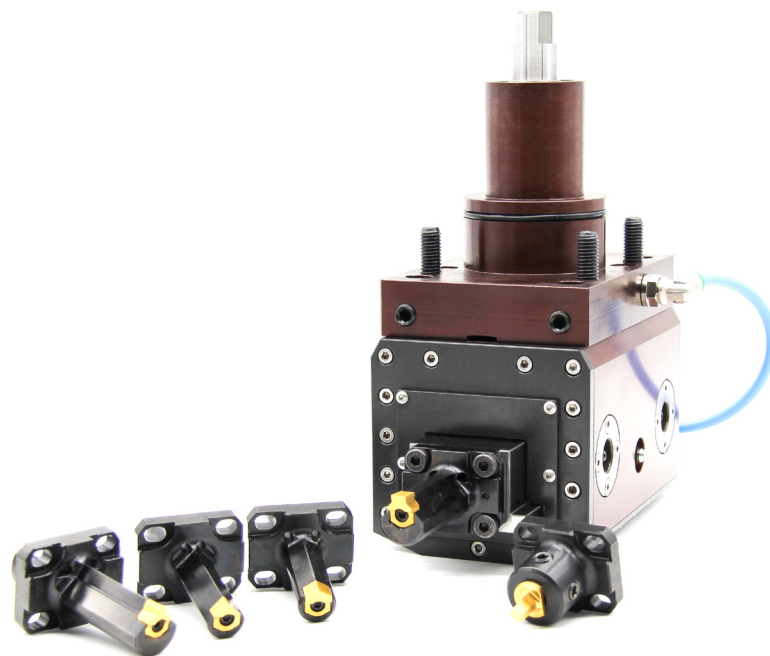

MH Slotting Series Insert Holder

The line of tools illustrated here was developed for use on motorized slotting machines for CNC lathes. With the line of tools for motorized slotting machines, it is possible to use the inserts of standard lines for keyway seatings, for hexagonal profiles and for square profiles. It is also possible to manufacture tools and inserts for special profiles. The technical data table does not include the measurements for the diameter and length of the side designed for clamping inside the motorized slotting machine, as these measurements are defined case by case based on customer demands. The picture below is provided by way of example and illustrates one of the many possible shapes that the tool legs can have.

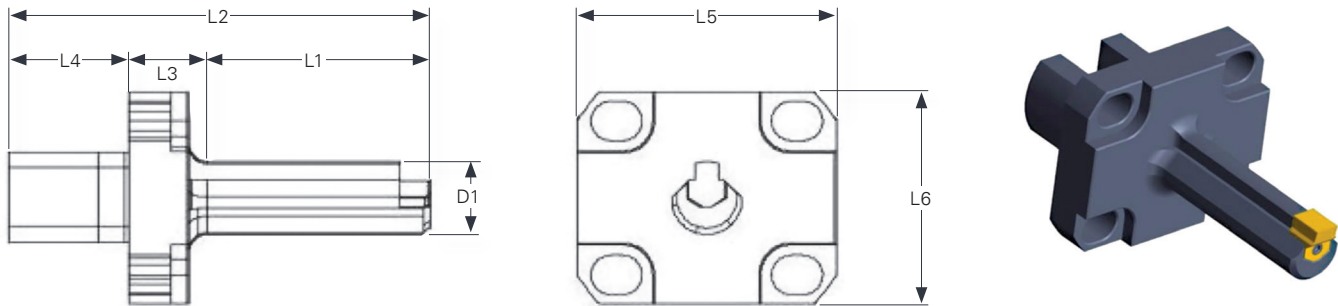

MH 35 / 50 / 65 Slotting Series Insert Holder

EDP No.	Description	L1 (mm)	L2 (mm)	L3 (mm)	L4 (mm)	L5 (mm)	L6 (mm)	D1 (mm)	Centering Plate	Torx driver	Mounting screw	Minimum Bore Dia.		Minimum hole (mm)	Weight (g)
												(mm)	(inch)		
99161	02-35	25	58	13	20	43	35	6	CP-0	T-08	MS-1	7	0.276	7	0.150
99162	03-35	30	63	13	20	43	35	8	CP-1	T-08	MS-1	8.5	0.335	8.7	0.160
99163	04-35	40	73	13	20	43	35	10	CP-1	T-08	MS-1	10.5	0.413	11	0.170
99164	05-35	46	79	13	20	43	35	12	CP-1	T-08	MS-1	12.5	0.492	13	0.180
99165	06-35	46	79	13	20	43	35	16	CP-2	T-15	MS-2	16.5	0.650	17	0.210
99166	08-35	46	79	13	20	43	35	20	CP-2	T-15	MS-2	21	0.827	21.5	0.225
99167	10/12-35	46	79	13	20	43	35	22	CP-3	T-20	MS-3	28/30	1.102/1.181	24	0.235
99168	14/16-35	46	79	13	20	43	35	25	CP-4	T-20	MS-3	35	1.378	27	0.245
99169	02-50	25	58	13	20	43	35	6	CP-0	T-08	MS-1	7	0.276	7	0.150
99170	03-50	30	63	13	20	43	35	8	CP-1	T-08	MS-1	8.5	0.335	8.7	0.160
99171	04-50	40	73	13	20	43	35	10	CP-1	T-08	MS-1	10.5	0.413	11	0.170
99172	05-50	46	79	13	20	43	35	12	CP-1	T-08	MS-1	12.5	0.492	13	0.180
99173	06-50	56	89	13	20	43	35	16	CP-2	T-15	MS-2	16.5	0.650	17	0.210
99174	08-50	56	89	13	20	43	35	20	CP-2	T-15	MS-2	21	0.827	21.5	0.225
99175	10/12-50	56	89	13	20	43	35	22	CP-3	T-20	MS-3	28/30	1.102/1.181	24	0.235
99176	14/16-50	56	89	13	20	43	35	25	CP-4	T-20	MS-3	35	1.378	27	0.245
99177	02-65	25	58	13	20	43	35	6	CP-0	T-08	MS-1	7	0.276	7	0.150
99178	03-65	30	63	13	20	43	35	8	CP-1	T-08	MS-1	8.5	0.335	8.7	0.160
99179	04-65	40	73	13	20	43	35	10	CP-1	T-08	MS-1	10.5	0.413	11	0.170
99180	05-65	46	79	13	20	43	35	12	CP-1	T-08	MS-1	12.5	0.492	13	0.210
99181	06-65	56	89	13	20	43	35	16	CP-2	T-15	MS-2	16.5	0.650	17	0.180
99182	08-65	68	102	13	20	43	35	20	CP-2	T-15	MS-2	21	0.827	21.5	0.240
99183	10/12-65	70	103	13	20	43	35	22	CP-3	T-20	MS-3	28/30	1.102/1.181	24	0.265
99184	14/16-65	70	103	13	20	43	35	25	CP-4	T-20	MS-3	35	1.378	27	0.285

See pages 55-57 for accessories.

See pages 43-44 for inserts

MH Square Series Insert Holder

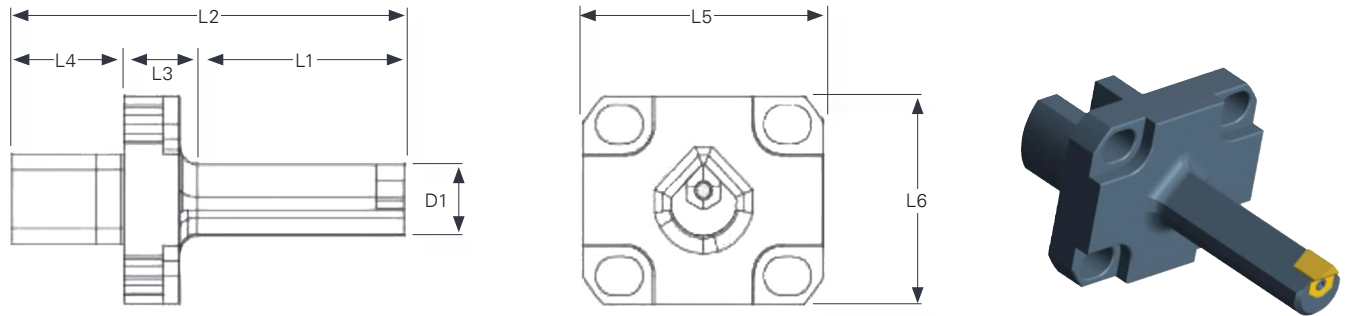

MH 35 / 50 / 65 Square Series Insert Holder

EDP No.	Description	L1 (mm)	L2 (mm)	L3 (mm)	L4 (mm)	L5 (mm)	L6 (mm)	D1 (mm)	Centering Plate	Torx driver	Mounting screw	Minimum hole (mm)	Weight (g)
10000*	8/10-35	30	58	13	20	43	35	7.25	CP-1	T-08	MS-1	8	0.150
10001*	10/13-35	40	63	13	20	43	35	8.6	CP-1	T-08	MS-1	10	0.160
10002*	13/16-35	46	73	13	20	43	35	12	CP-2	T-15	MS-2	13	0.170
10003*	16/19-35	46	79	13	20	43	35	15	CP-3	T-20	MS-3	16	0.180
10004*	19/27-35	46	79	13	20	43	35	18.5	CP-3	T-20	MS-3	19	0.210
10005*	27/37-35	46	79	13	20	43	35	25	CP-4	T-20	MS-3	27	0.225
10006*	8/10-50	30	58	13	20	43	35	7.25	CP-1	T-08	MS-1	8	0.150
10007*	10/13-50	40	63	13	20	43	35	8.6	CP-1	T-08	MS-1	10	0.160
10008*	13/16-50	50	77	13	20	43	35	12	CP-2	T-15	MS-2	13	0.170
10009*	16/19-50	52	87	13	20	43	35	15	CP-3	T-20	MS-3	16	0.210
10010*	19/27-50	60	93	13	20	43	35	18.5	CP-3	T-20	MS-3	19	0.225
10011*	27/37-50	60	93	13	20	43	35	25	CP-4	T-20	MS-3	27	0.285
10012*	8/10-65	30	58	13	20	43	35	7.25	CP-1	T-08	MS-1	8	0.150
10013*	10/13-65	40	63	13	20	43	35	8.6	CP-1	T-08	MS-1	10	0.160
10014*	13/16-65	50	77	13	20	43	35	12	CP-2	T-15	MS-2	13	0.170
10015*	16/19-65	52	87	13	20	43	35	15	CP-3	T-20	MS-3	16	0.210
10016*	19/27-65	75	108	13	20	43	35	18.5	CP-3	T-20	MS-3	19	0.290
10017*	27/37-65	75	108	13	20	43	35	25	CP-4	T-20	MS-3	27	0.315

*please allow 2-4 weeks for delivery.

See pages 55-57 for accessories.

See page 46 for inserts.

Pre-Hole Diameter = Square Thickness X 1.050

For example, for a square with a thickness of 10mm, the diameter of the pre-hole will be: 10mm x 1.050 = 10.50mm

To execute completely square holes, the customer will need to make a specific request and will be supplied with an ad hoc tool.

In addition to this, in many other cases, to obtain a perfectly appropriate tool for the type of square hole that needs to be executed, it will be possible to produce a special tool that meets the customer's specifications.

MH Hexagon Series Insert Holder

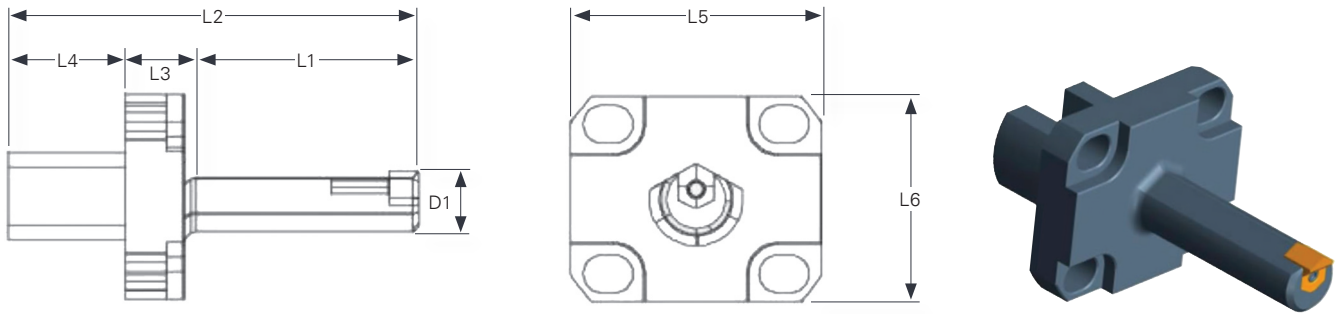

MH 35 / 50 / 65 Hexagon Series Insert Holder

EDP No.	Description	L1 (mm)	L2 (mm)	L3 (mm)	L4 (mm)	L5 (mm)	L6 (mm)	D1 (mm)	Centering Plate	Torx driver	Mounting screw	Minimum hole (mm)	Weight (g)
10018*	9/11-35	30	58	13	20	43	35	8	CP-1	T-08	MS-1	8.7	0.150
10019*	11/17-35	40	63	13	20	43	35	10	CP-1	T-08	MS-1	11	0.160
10020*	17/28-35	46	73	13	20	43	35	15	CP-2	T-15	MS-2	16	0.170
10021*	28/37-35	46	79	13	20	43	35	25	CP-3	T-20	MS-3	27	0.180
10022*	37/45-35	46	79	13	20	43	35	28	CP-4	T-20	MS-3	30	0.270
10023*	9/11-50	30	58	13	20	43	35	8	CP-1	T-08	MS-1	8.7	0.150
10024*	11/17-50	40	63	13	20	43	35	10	CP-1	T-08	MS-1	11	0.160
10025*	17/28-50	60	73	13	20	43	35	15	CP-2	T-15	MS-2	16	0.210
10026*	28/37-50	60	79	13	20	43	35	25	CP-3	T-20	MS-3	27	0.225
10027*	37/45-50	60	79	13	20	43	35	28	CP-4	T-20	MS-3	30	0.245
10028*	9/11-65	30	58	13	20	43	35	8	CP-1	T-08	MS-1	8.7	0.150
10029*	11/17-65	40	73	13	20	43	35	10	CP-1	T-08	MS-1	11	0.160
10030*	17/28-65	60	93	13	20	43	35	15	CP-2	T-15	MS-2	16	0.210
10031*	28/37-65	75	108	13	20	43	35	25	CP-3	T-20	MS-3	27	0.225
10032*	37/45-65	75	108	13	20	43	35	28	CP-4	T-20	MS-3	30	0.275

*Please allow 2-4 weeks for delivery.

See pages 55-57 for accessories.

See page 47 for inserts.

Pre-Hole Diameter = Square Thickness X 1.020

For example, for a hexagon with a thickness of 10mm, the diameter of the pre-hole will be: 10mm x 1.020 = 10.20mm

To achieve your desired hexagonal hole, contact our Engineering Department for a custom solution to meet your needs.

MH-Spline Series Insert Holder

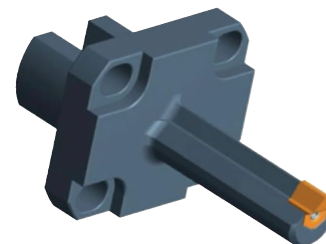
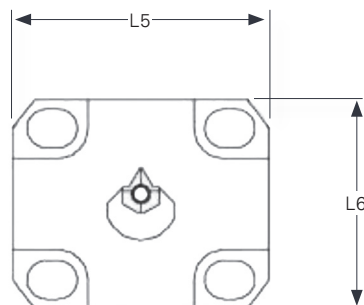
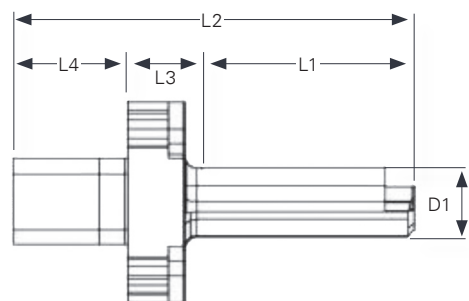

MH-Spline 35 / 50 / 65 Series Insert Holder

EDP No.	Description	L1 (mm)	L2 (mm)	L3 (mm)	L4 (mm)	L5 (mm)	L6 (mm)	D1 (mm)	Centering Plate	Torx driver	Mounting screw	Minimum hole (mm)	Weight (g)
10033*	02-35	25	58	13	20	43	35	6.5	CP-0	T-08	MS-1	7	0.150
10034*	03-35	30	63	13	20	43	35	8	CP-1	T-08	MS-1	8.7	0.160
10035*	04-35	40	73	13	20	43	35	10	CP-1	T-08	MS-1	11	0.170
10036*	05-35	46	79	13	20	43	35	12	CP-1	T-08	MS-1	13	0.180
10037*	06-35	46	79	13	20	43	35	16	CP-2	T-15	MS-2	17	0.210
10038*	08-35	46	79	13	20	43	35	20	CP-2	T-15	MS-2	21.5	0.225
10039*	10-35	46	79	13	20	43	35	22	CP-3	T-20	MS-3	24	0.235
10040*	12-35	46	79	13	20	43	35	25	CP-3	T-20	MS-3	27	0.245
10041*	14/16-35	46	79	13	20	43	35	28	CP-4	T-20	MS-3	30	0.245
10042*	02-50	25	58	13	20	43	35	6.5	CP-0	T-08	MS-1	7	0.150
10043*	03-50	30	63	13	20	43	35	8	CP-1	T-08	MS-1	8.7	0.160
10044*	04-50	40	73	13	20	43	35	10	CP-1	T-08	MS-1	11	0.170
10045*	05-50	46	79	13	20	43	35	12	CP-1	T-08	MS-1	13	0.180
10046*	06-50	56	89	13	20	43	35	16	CP-2	T-15	MS-2	17	0.210
10047*	08-50	60	93	13	20	43	35	20	CP-2	T-15	MS-2	21.5	0.245
10048*	10-50	60	93	13	20	43	35	22	CP-3	T-20	MS-3	24	0.265
10049*	12-50	60	93	13	20	43	35	25	CP-3	T-20	MS-3	27	0.285
10050*	14/16-50	60	93	13	20	43	35	28	CP-4	T-20	MS-3	30	0.310
10051*	02-65	25	58	13	20	43	35	6.5	CP-0	T-08	MS-1	7	0.150
10052*	03-65	30	63	13	20	43	35	8	CP-1	T-08	MS-1	8.7	0.160
10053*	04-65	40	73	13	20	43	35	10	CP-1	T-08	MS-1	11	0.170
10054*	05-65	46	79	13	20	43	35	12	CP-1	T-08	MS-1	13	0.180
10055*	06-65	60	79	13	20	43	35	16	CP-2	T-15	MS-2	17	0.210
10056*	08-65	70	100	13	20	43	35	20	CP-2	T-15	MS-2	21.5	0.245
10057*	10-65	75	108	13	20	43	35	22	CP-3	T-20	MS-3	24	0.265
10058*	12-65	75	108	13	20	43	35	25	CP-3	T-20	MS-3	27	0.310
10059*	14/16-65	75	108	13	20	43	35	28	CP-4	T-20	MS-3	30	0.310

*please allow 2-4 weeks for delivery. When ordering please provide your machine turret model (BMT, VDI, etc.) for easier installation. See pages 55-57 for accessories.

Note: Inserts used on the tool line for splined profiles are all considered special: they are not in stock; rather, they are manufactured specifically for the customer based on the type of machining required. Please contact us for a quote.

MH-M Series Tool Holder Adaptor for the MINITOOL

10mm D

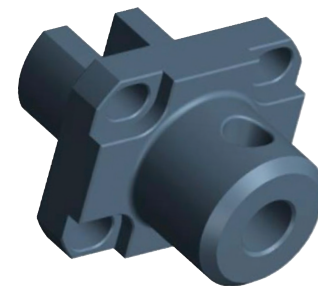
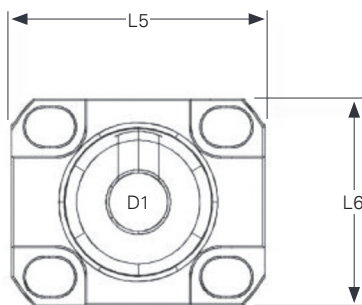
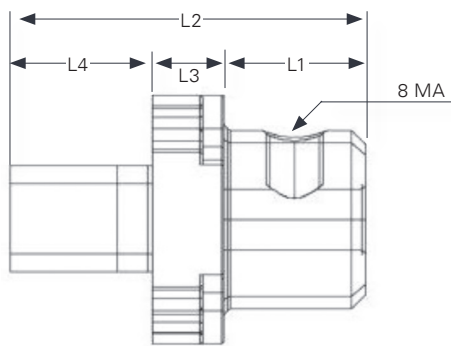

MH-M 35 / 50 / 65 Series Tool Holder Adaptor

EDP No.	L1 (mm)	L2 (mm)	L3 (mm)	L4 (mm)	L5 (mm)	L6 (mm)	D1 (mm)	Centering Plate	Torx driver	Mounting screw	Minimum hole (mm)	Weight (g)
10060*	20	50	15	20	43	35	10	-	-	-	-	-
10061*	20	50	15	20	43	35	10	-	-	-	-	-
10062*	20	50	15	20	43	35	10	-	-	-	-	-

*please allow 2-4 weeks for delivery.

See pages 41-42 and 46-48 for Tool Holders.

MINITOOL

***All Tools are Custom Made to Order**

The MINITOOL series was developed based on the need to satisfy demands linked to machining small workpieces. Integral inserts were used to satisfy these demands, as these types of inserts make it possible to achieve extremely small cutting profiles, with very diverse geometries. In order to ensure high tool rigidity and achieve tools that are absolutely perfect for the operation that needs to be performed, the integral inserts are always designed ad hoc based on specific customer demands. To ensure the prompt supply of tools, Pilot Precision Products always has a stock of semi-finished MINITOOL inserts and has developed specific programs for its CNC sharpening machines, aimed at profiling inserts based on customer demands, in extremely short amounts of time. MINITOOL series inserts can fit UT-1/8 insert-carrier (available in different socket diameters). The aforementioned insert-carrier can, in turn, be internally fitted with eccentric bushing, the same way as the classic line duMONT tool and, therefore, can correct any alignment errors on CNC lathes that are not equipped with a Y-axis. Alternatively, MINITOOL inserts can be locked into the machine tool-carrier with a simple clamping gripper (for ex. an ER gripper). In this case, it is preferable for the machine tool to be equipped with a Y-axis.

Tool 1/8

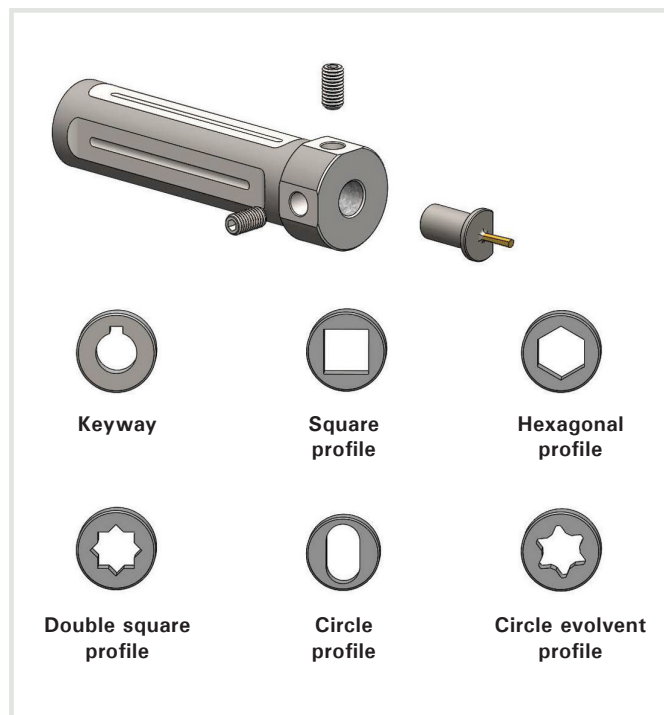
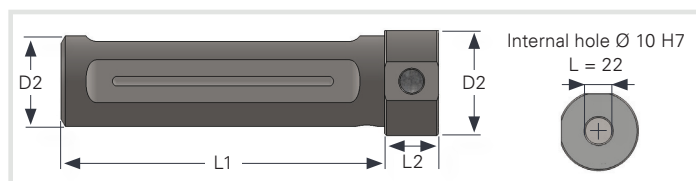

Tools for External Machining (mm)

EDP No.	Description	L1 (mm)	L2 (mm)	D1 (mm)	D2
99906	1/8-3/4"	90		30	3/4"
99907	1/8-20mm	90	15	30	20mm
99908	1/8-25mm	90		30	25mm
99909	1/8-32mm	100		38	32mm

*Reference pg. 68 - Hassay Custom Push Broaches

Index Broach with 10mm Shank for MINITOOL

Hex and Hexalobe 

An Alternative To Full Form Rotary Broaching

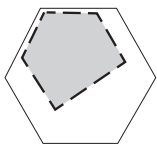

Single Point Hex Broach

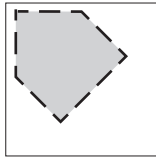

Single Point Square Form



2 Point Hex Index Broach

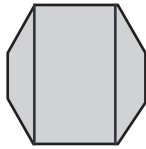

4 Point Index Hex Broach

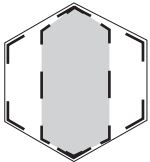

Full 6 Point Hex Form

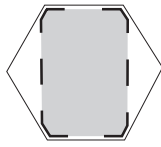

Full 4 Point Hex Form

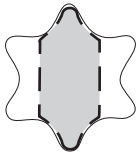

Full 6 Lobe Form



2 Index Lobe Broach

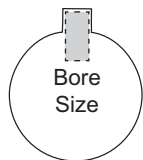

Keyway Shaper

Required Tooling Includes:

- 90° Spot/Chamfer Tool
- Desired Pilot Drill
- Index Punch Broach

Typical Applications Include:

- Hexagonal
- Double Hexagonal
- 6 Lobe / Hexalobe
- Square
- Keyways / Slots / Splines

Index Broaches can be made in the NEW MAX Alloy

HassayMAX

2 or 4 Point Hex Broach Cutting Process

- Hole preparation completed with chamfer & proper pilot hole size
- Machine spindle locked
- Punch enters the work piece, cutting the work piece, then retracts.
- The machine spindle indexes 60° then locks
- The punch enters the work piece a second time, cutting the work piece, then retracts
- Machine spindle indexes 60° then locks
- Punch enters for a third and final imprint
- Drill or boring bar used to make pilot hole can re-enter cut and remove ribbons and chips formed inside the cut



Hex or Square Broach

2 Point Hex Broach Cutting Procedure is effective for broaching materials with higher tensile strength and relieves overall pressure during the process.



4 Point Hex Broach Cutting Procedure is effective for index broaching titanium and stainless steel materials to help improve better tolerances and surface finishes in the finished part.



6 Lobe Hexalobe Broach Cutting Procedures are similar procedures as 2 point or 4 point broach cutting. The process reduces overall pressure, improves tolerances and surface finishes. Ideal for automated production.



Why Hassay Savage Index Broaches?

- For Longer Production Runs
- Superb Surface Finishes
- Outstanding Tool Life in Stainless & Titanium
- Special Sizes, Special tolerances in Less Than 5 Days
- Produce bone screws to ± 0.0002 Tolerance



Engineering Section



Special Inserts and Applications

The CNC Indexable Broaching System offers a wide range of Special Design Inserts that provide the opportunity to manufacture parts more efficiently and accurately through single machine processing. When location or timing is a critical design element of the part, the tooling system offers a means to do more work within the same coordinate system. Allow us to put our experience to work for you. Get the right Insert for the material you are machining, the shape or form you require with the programming needed to get your job done. Please contact us at 413-350-5200.

Blind Hole Inserts

Blind Hole Cutting requires a Special Insert. The Insert's composition and hardness is altered to reduce the risk of chipping. Additional design considerations are required for small diameter holes with restricted chip flow, deep hole cutting, and when working with bars of material in lathe operations. The programs used for Blind Hole Cutting require that special attention be given to the end of each stroke and the retraction of the Insert. A straight X-axis move out of the work can result in chipping of the Insert. Programming assistance is available; the manufacturer, model, and controls of the machine to be used as well as a fully dimensioned drawing of the finished part are required. The proper design, insert material, and programming is essential to success.

Cornering Inserts

Machine Squares, Hexagons, and Octagons with Inserts designed with two cutting edges intersecting at the appropriate angle 90°, 120° or 135°. Cut the corner, rotate the spindle (C axis) as required for the next cut (re-run of the subroutine) and repeat to completion. The same cornering Inserts may be used to generate a range of sizes of the given shape by simply increasing or decreasing the tool offset.

Internal Tothing and Grooving Inserts

Inserts designed to meet industry standards (ANSI, DIN, ISO etc.) as well as nonstandard geometries are available. A chamfering feature may be added in order to produce a burr-free part. One machine processing in the same coordinate system promotes product uniformity and processing efficiencies.

Sharpening – Allow us to extend the life of your inserts

Re-sharpening extends the life of the Insert and saves money. The Inserts that show a decline in surface finish (a sign of wear), can have their life extended through a resharpener process. The Inserts are designed to allow two to three resharpenings, more if tolerances allow. A Sharpening Stem is available for mounting and supporting of an Insert during re-sharpening. The Stem's hexagon shank facilitates the resharpener process. Sharpening must be properly performed using an appropriate grinder and grinding wheel. The original cutting angle must be maintained. Recoating of the Insert is required after sharpening.

Contact us for a quote to re-sharpen your inserts to proper manufactured geometry.

CNC Programming Support

Programming – Allow us to put our experience to work for you.

Programming assistance is available; the make, model, and controls of the machine used, along with a print drawing of the part, is required.

In the CNC program, it is necessary to establish an approaching value which accounts for the "cord," the distance from the center of the cutting edge of the Insert to I.D. of the bore at the point the corners of the Inserts contact the I.D. of the bore. This distance is a function of Insert width and Bore Diameter. The approaching value being sufficiently lower than the diameter of the bore avoids damage to the Insert.

On-site engineering programming service is available at an hourly rate plus travel costs.

**It is necessary on larger cuts 12mm or ½ inch keyways and above to cut in two operations, a roughing pass with a smaller width insert

(approximate ½ required width) and finishing pass at the desired width. This approach reduces the pressure required.

Engineering Section - Tool Holder Speeds & Feeds

Aluminum				Bronze			Mild Steel / Low Alloy Steel			High Alloy Steel			Stainless		
Width of Insert	Cut per Stroke (inch)	Cutting Speed (inches/min)	Pressure Required (lbs)	Cut per Stroke (inch)	Cutting Speed (inches/min)	Pressure Required (lbs)	Cut per Stroke (inch)	Cutting Speed (inches/min)	Pressure Required (lbs)	Cut per Stroke (inch)	Cutting Speed (inches/min)	Pressure Required (lbs)	Cut per Stroke (inch)	Cutting Speed (inches/min)	Pressure Required (lbs)
3/32	0.0060	480	71	0.0040	340	132	0.0035	300	182	0.0030	230	170	0.0023	200	141
1/8	0.0060	480	94	0.0040	340	176	0.0035	300	242	0.0028	230	211	0.0025	200	204
5/32	0.0060	480	118	0.0040	340	220	0.0035	300	302	0.0025	230	235	0.0023	200	235
3/16	0.0060	480	141	0.0040	340	236	0.0033	300	342	0.0025	230	282	0.0023	200	281
1/4	0.0055	480	172	0.0032	340	281	0.0025	300	345	0.0022	230	331	0.0020	200	326
9/32	0.0055	400	194	0.0032	300	316	0.0022	265	341	0.0021	200	355	0.0020	175	366
5/16	0.0050	400	196	0.0032	300	351	0.0022	265	379	0.0020	200	376	0.0019	175	387
3/8	0.0050	400	235	0.0027	300	355	0.0019	265	393	0.0017	200	384	0.0016	175	391
7/16	0.0044	400	241	0.0027	300	414	0.0018	265	434	0.0016	200	421	0.0015	175	428
1/2	0.0042	380	263	0.0026	270	456	0.0016	230	441	0.0015	180	451	0.0014	150	456
9/16	0.0040	380	282	0.0024	270	473	0.0016	230	496	0.0014	180	473	0.0013	150	476
5/8	0.0040	380	313	0.0023	270	504	0.0015	230	517	0.0014	180	526	0.0013	150	529
3/4	0.0035	380	329	0.0020	270	526	0.0013	230	538	0.0012	180	541	0.0011	150	538
2mm	0.0060	480	59	0.0040	340	110	0.0035	300	151	0.0025	230	118	0.0023	200	118
3mm	0.0060	480	89	0.0040	340	165	0.0035	300	227	0.0025	230	177	0.0023	200	176
4mm	0.0060	480	118	0.0040	340	220	0.0035	300	303	0.0025	230	236	0.0023	200	235
5mm	0.0060	480	148	0.0036	340	248	0.0033	300	357	0.0025	230	295	0.0023	200	294
6mm	0.0055	480	162	0.0032	340	264	0.0033	300	429	0.0022	230	312	0.0020	200	307
8mm	0.0055	400	216	0.0032	300	353	0.0025	265	433	0.0020	200	378	0.0018	175	368
10mm	0.0050	400	246	0.0027	300	372	0.0020	265	433	0.0017	200	401	0.0016	175	409
12mm	0.0045	380	266	0.0027	270	446	0.0019	230	494	0.0015	180	425	0.0014	150	430
14mm	0.0040	380	276	0.0025	270	482	0.0017	230	515	0.0013	180	430	0.0013	150	466
16mm	0.0040	380	315	0.0022	270	485	0.0015	230	520	0.0013	180	491	0.0011	150	450
18mm	0.0037	380	328	0.0020	270	496	0.0014	230	546	0.0012	180	510	0.0010	150	461
20mm	0.0034	360	335	0.0019	250	523	0.0013	200	563	0.0012	150	567	0.0010	130	512
22mm	0.0032	360	346	0.0018	250	546	0.0012	200	571	0.0010	150	520	0.0010	130	535
25mm	0.0032	360	394	0.0017	250	585	0.0011	200	595	0.0009	150	531	0.0009	130	544

Slotter Speeds & Feeds

To help ensure a long service life for your broaching tools and an excellent processing finish, it is advisable to follow these parameters:

	35 mm Ram Stroke	50 mm Ram Stroke	65 mm Ram Stroke	RPM = cut speed ÷ (ram stroke x 2)	
	Insert Width	Insert Width	Insert Width	Cutting speed	Cut per Stroke Min / Max
Aluminum	5/8 in.	5/8 in.	5/8 in.	1496 in./min.	.0023/.0059 in.
Soft steel	9/16 in.	9/16 in.	9/16 in.	1299 in./min.	.0015/.0027 in.
Cast iron	9/16 in.	9/16 in.	1/2 in.	1102 in./min.	.0015/.0027 in.
Common steel	9/16 in.	9/16 in.	1/2 in.	1181 in./min.	.0011/.0019 in.
Hardened steel	1/2 in.	1/2 in.	3/8 in.	984 in./min.	.0007/.0015 in.
Stainless steel	1/2 in.	1/2 in.	3/8 in.	984 in./min.	.0007/.0015 in.
Plastic	3/4 in.	3/4 in.	3/4 in.	1574 in./min.	.0027/.0059 in.
Bronze-Brass	9/16 in.	1/2 in.	1/2 in.	1181 in./min.	.0011/.0023 in.

Distance from Centerline to Cutting Edge



Square	
IN	Tool Radius(mm)
SQ-8/10	4.25
SQ-10/13	4.80
SQ-13/16	7
SQ-16/9	8.50
SQ-19/27	10.75
SQ-27/37	14.5
SQ-37/50	20.5

Hex	
IN	Tool Radius(mm)
HEX-9/11	4.5
HEX-11/17	5.5
HEX-17/28	8.5
HEX-28/37	14
HEX-37/45	19.50
HEX-45/70	23

Standard Keyway	
IN	Tool Radius(mm)
UT-2	3.50
UT-3	4.50
UT-4	5.50
UT-5	6.50
UT-6	9.00
UT-8	11.00
UT=10	14.00
UT-12	15.50
UT-14/16	19.00
UT-18/26	22.00





Hassay Savage

Rotary Broaching & Tool Holders

PILOT

Hexagonal Rotary Punch Broaches	64
Hexagonal Rotary Punch Broaches M-2 and MAX	65
Square Rotary Punch Broaches	66
Rotary Broaching Set-Up Plugs	67
Index Broaching	68
Adjustable Rotary Broach Holders	69
Swiss-Style Non-Adjustable Holders	70
Use Recommendations	71
Static Index Punch Broach Holders	72
Quick Change ER Collet Punch & Index Broach ER Holder Systems	72
Ultra-Precision Floating Reamer Holders	73
Advanced Precision Micro Tool Holders	73
Micro-XL Tool Holders - Micro End Mill Extensions	74

PILLOT

Hexagonal Rotary Punch Broaches

Material: **MAX Proprietary Alloy** For More Difficult To Machine Materials

MAX Out Your Rotary Broaching

2X Tool Life *Compared to a T-15*

37% Decrease in Overall CPP (Cost Per Part)

Hassay **MAX**

Manufactured from custom hardened alloys, these hex, square and punch rotary broaches are a **specialty formulated material** that combines high hardness with exceptional abrasion resistance and toughness.

They're ideal for sockets where long tool life is required and are intended for use on materials with hardness up to 50 Hrc, such as:

- Cobalt-Chrome
- Titanium
- Custom 455
- Inconel 718
- Biodur 108 & 22-13-15
- Monel
- 17-4 Stainless Steel
- Hardened A286/304
- Strain Hardened 316
- 303 Stainless Steel

Our rotary broaches offer many **advantages** over conventional coated & uncoated broaching tools, including:

- Edge Toughness for High Production Applications
- Better Heat Resistance
- 2x-10x Longer Tool Life

*Also offered in Swiss style - see pg. 67



Proprietary Alloy

Ideal for Applications in These Industries



Fasteners



Automotive



Electronics



Medical/Dental



Aerospace



Defense

Hexagonal Rotary Punch Broaches M-2 and MAX



Material: **M-2 HSS** for mild steel applications,
MAX Alloy available for more difficult to machine alloys

Rotary/Punch Broaches:

- Use in a variety of machines
- Cut polygons in blind holes
- Any type of CNC or manual turning, milling, drilling or screw machine.

Punching Versus Rotary Broaching:

Many applications can be achieved without the rotary broach holder.

For the purpose of merely punching a polygon into an existing pilot hole, these broaches have successfully been used with universal machining methods.



Hexagonal Rotary/Punch Broaches 1/2" – 0.500 Shank					
Hex Size (inch)	Across Flats +0.001 / -0.000	Max. Depth of Cut	Overall Length*	EDP No. Hassay Savage	EDP No. Hassay Savage MAX
3/32	0.095	7/32	1-3/4	66106	66106-M
7/64	0.111	1/4		66107	66107-M
1/8	0.127	1/4		66108	66108-M
9/64	0.143	5/16		66109	66109-M
5/32	0.158	5/16		66110	66110-M
3/16	0.190	3/8		66112	66112-M
7/32	0.221			66114	66114-M
1/4	0.252			66116	66116-M
9/32	0.284	7/16		66118	66118-M
5/16	0.315	7/16		66120	66120-M
11/32	0.346	11/16		66122	66122-M
3/8	0.378			66124	66124-M
13/32	0.410			66126	66126-M
7/16	0.441	5/8		66128	66128-M
15/32	0.472			66130	66130-M
1/2	0.504		66132	66132-M	
9/16	0.567	5/8	66136	66136-M	
5/8	0.630		66140	66140-M	
11/16	0.693		66144	66144-M	
3/4	0.755		66148	66148-M	

Hexagonal Rotary/Punch Broaches 8mm – 0.315 Shank					
Hex Size (inch)	Across Flats +0.001 / -0.000	Max. Depth of Cut	Overall Length*	EDP No. Hassay Savage	EDP No. Hassay Savage MAX
.050	0.050	7/64	1-1/4	66002	66002-M
1/16	0.063	5/32		66004	66004-M
5/64	0.079	9/64		66005	66005-M
3/32	0.095	7/32		66006	66006-M
7/64	0.111	7/32		66007	66007-M
1/8	0.127	1/4		66008	66008-M
9/64	0.143	9/32		66009	66009-M
5/32	0.158	5/16		66010	66010-M
3/16	0.190	11/32		66012	66012-M
7/32	0.221	13/32		66014	66014-M
1/4	0.252	7/16		66016	66016-M
9/32	0.284			66018	66018-M
5/16	0.315			66020	66020-M
11/32	0.346	7/16		66022	66022-M
3/8	0.378	1/2		66024	66024-M
13/32	0.410		66026	66026-M	
7/16	0.441		66028	66028-M	
15/32	0.472	1/2	66030	66030-M	
1/2	0.504		66032	66032-M	

HassayMAX



Metric Hexagonal Rotary/Punch Broaches 1/2" – 0.500 Shank					
Hex Size (mm)	Across Flats +0.001 / -0.000	Max. Depth of Cut	Overall Length*	EDP No. Hassay Savage	EDP No. Hassay Savage MAX
2.0	0.081	1-3/4	66302	66302-M	
2.5	0.101		7/32	663025	663025-M
3.0	0.120		1/4	66303	66303-M
4.0	0.160		5/16	66304	66304-M
5.0	0.199		3/8	66305	66305-M
6.0	0.238		7/16	66306	66306-M
7.0	0.278		1/2	66307	66307-M
8.0	0.320		9/16	66308	66308-M
9.0	0.358			66309	66309-M
10.0	0.399			66310	66310-M
11.0	0.437		5/8	66311	66311-M
12.0	0.476		5/8	66312	66312-M
13.0	0.516			66313	66313-M
14.0	0.556			66314	66314-M
15.0	0.597		7/8	66315	66315-M
16.0	0.636	66316		66316-M	
17.0	0.674	66317		66317-M	
18.0	0.714	66318		66318-M	
19.0	0.754	66319		66319-M	

*Overall Tool Length Tolerances +/- .015

Metric Hexagonal Rotary/Punch Broaches 8mm – 0.315 Shank					
Hex Size (mm)	Across Flats +0.001 / -0.000	Max. Depth of Cut	Overall Length*	EDP No. Hassay Savage	EDP No. Hassay Savage MAX
1.3	0.050	5/64	1-1/4	662013	662013-M
1.5	0.061	3/32		662015	662015-M
2.0	0.081	9/64		66202	66202-M
2.5	0.101	7/32		662025	662025-M
3.0	0.120	1/4		66203	66203-M
3.5	0.139	1/4		662035	662035-M
4.0	0.160	5/16		66204	66204-M
4.5	0.179	5/16		662045	662045-M
5.0	0.199	3/8		66205	66205-M
6.0	0.238	7/16		66206	66206-M
7.0	0.278	7/16		66207	66207-M
8.0	0.319	7/16		66208	66208-M
9.0	0.358	7/16		66209	66209-M
10.0	0.399	1/2		66210	66210-M
11.0	0.437	1/2		66211	66211-M
12.0	0.476	1/2	66212	66212-M	

Hexagonal Rotary/Punch Broaches 3/4" – 0.750 Shank					
Hex Size (inch)	Across Flats +0.001 / -0.000	Max. Depth of Cut	Overall Length*	EDP No. Hassay Savage	EDP No. Hassay Savage MAX
3/8	0.379	3/4	2-3/4	66524	66524-M
7/16	0.442			66528	66528-M
1/2	0.505			3/4	66532
9/16	0.567	7/8		66536	66536-M
5/8	0.631			66540	66540-M
3/4	0.754			66548	66548-M
7/8	0.883	7/8	66556	66556-M	
1.0	1.014		66564	66564-M	

The practical forming length of rotary punch broaching is usually up to 1-1/2 times the size of the broach (measured across flats).

Square Rotary Punch Broaches

1/16 thru 3/8 inch

1.5mm thru 12mm

Material: **M-2 HSS** for mild steel applications,
MAX Alloy available for more difficult to machine alloys

Square Rotary/Punch Broaches 8mm-.315 Shank					
Square Size (inch)	Across Flats +0.001 / -0.000	Max. Depth of Cut	Overall Length*	EDP No. Hassay Savage	EDP No. Hassay Savage MAX*
1/16	0.063	3/16	1-1/4	68004	68004-M
3/32	0.095	3/16		68006	68006-M
1/8	0.127	7/32		68008	68008-M
5/32	0.158	9/32		68010	68010-M
3/16	0.190	11/32		68012	68012-M
7/32	0.221	3/8		68014	68014-M
1/4	0.252	3/8		68016	68016-M
9/32	0.284			68018	68018-M
5/16	0.315			68020	68020-M
11/32	0.346			68022	68022-M
3/8	0.379		68024	68024-M	

Metric Square Rotary/Punch Broaches 8mm-.315 Shank					
Square Size (mm)	Across Flats +0.001 / -0.000	Max. Depth of Cut	Overall Length*	EDP No. Hassay Savage	EDP No. Hassay Savage MAX*
1.5	0.0605	5/32	1-1/4	682015	682015-M
2.0	0.0805	5/32		68202	68202-M
2.5	0.101	3/16		682025	682025-M
3.0	0.120	7/32		68203	68203-M
3.5	0.139			682035	682035-M
4.0	0.160	5/16		68204	68204-M
4.5	0.179			682045	682045-M
5.0	0.199	3/8		68205	68205-M
6.0	0.238			68206	68206-M
7.0	0.278			68207	68207-M
8.0	0.319		68208	68208-M	
9.0	0.358		1/2	68209	68209-M
10.0	0.398	68210		68210-M	



Use With:

- Screw Machines
- CNC Machines

The practical forming length of rotary punch broaching is usually up to 1-1/2 times the size of the broach (measured across flats).



Square Rotary/Punch Broaches 1/2-.500 Shank					
Square Size (inch)	Across Flats +0.001 / -0.000	Max. Depth of Cut	Overall Length*	EDP No. Hassay Savage	EDP No. Hassay Savage MAX*
3/32	0.095	3/16	1-3/4	68106	68106-M
1/8	0.127	7/32		68108	68108-M
5/32	0.158	9/32		68110	68110-M
3/16	0.190	5/16		68112	68112-M
7/32	0.221	3/8		68114	68114-M
1/4	0.252	7/16		68116	68116-M
9/32	0.284	1/2		68118	68118-M
5/16	0.315	9/10		68120	68120-M
11/32	0.346	5/8		68122	68122-M
3/8	0.378	5/8		68124	68124-M
7/16	0.441			68128	68128-M
1/2	0.504			68132	68132-M
9/16	0.567			3/4	68136
5/8	0.630	7/8		68140	68140-M

Square Rotary/Punch Broaches 3/4-.750 Shank					
Square Size (inch)	Across Flats +0.001 / -0.000	Max. Depth of Cut	Overall Length*	EDP No. Hassay Savage	EDP No. Hassay Savage MAX*
1/2	0.504	11/16	2-3/4	68532	68532-M
9/16	0.567	7/8		68536	68536-M
5/8	0.630			68540	68540-M
3/4	0.755	7/8		68548	68548-M

Metric Square Rotary/Punch Broaches 1/2-.500 Shank						
Square Size (mm)	Across Flats +0.001 / -0.000	Max. Depth of Cut	Overall Length*	EDP No. Hassay Savage	EDP No. Hassay Savage MAX*	
1.5	0.0605	1/8	1-3/4	683015	683015-M	
2.0	0.0805	5/32		68302	68302-M	
2.5	0.101	3/16		683025	683025-M	
3.0	0.120	1/4		68303	68303-M	
3.5	0.139	9/32		683035	683035-M	
4.0	0.160	5/16		68304	68304-M	
4.5	0.179	11/32		683045	683045-M	
5.0	0.199	3/8		68305	68305-M	
6.0	0.238	13/32		68306	68306-M	
7.0	0.278	7/16		68307	68307-M	
8.0	0.319			68308	68308-M	
9.0	0.358	1/2		68309	68309-M	
10.0	0.398			68310	68310-M	
11.0	0.437			9/16	68311	68311-M
12.0	0.476			5/8	68312	68312-M

*Overall Tool Length Tolerances +/- .015

SPECIAL ORDERS: We are fully equipped to manufacture Square Rotary Punch Broaches not listed above. Please contact Pilot Precision Products for details.

Rotary Broaching Set-Up Plugs

Standard plugs - for hex broach set-up only

Metric Rotary Broaching Set-Up Plugs* 8mm Shank

Size	Plug Dia. -0.001 - inch	Shank Dia. -0.013 - mm	Depth of Plug (inch)	OAL Overall Length (inch)	EDP No. Hassay Savage
1/8	0.129	8 mm	5/16	1-1/4	67008
3/16	0.193				67012
1/4	0.257				67016
5/16	0.321		3/8		67020
3/8	0.387				67024
1/2	0.515				67032

We can also supply you with custom turned diameters for your exact drill and bore size when repeatable set-ups are required for your job on a continuous basis, for both hex and square applications.

These will all come with the standard lengths and shank diameters of: 8mm, .500 and .750.



Standard Rotary Broaching Set-Up Plugs* 1/2 Inch Shank

Size	Plug Dia. -0.001 - inch	Shank Dia. .0.0005 - inch	Depth of Plug (inch)	OAL Overall Length (inch)	EDP No. Hassay Savage
3/16	0.193	0.500	5/16	1-3/4	67112
1/4	0.257				67116
3/8	0.387				67124
1/2	0.515		1/2		67132
5/8	0.643				67140

Standard Rotary Broaching Set-Up Plugs* 3/4 Inch Shank

Size	Plug Dia. -0.001 - inch	Shank Dia. -0.0005 - inch	Depth of Plug (inch)	OAL Overall Length (inch)	EDP No. Hassay Savage
3/8	0.387	0.750	1/2	2-3/4	67524
1/2	0.515				67532
5/8	0.643				67540
3/4	0.771		3/4		67548

*Stock inventories are standard diameter gauge-plugs with specifications to use in standard holders.

Swiss Style Rotary Punch Broaches

28mm OAL

For use with M2 and MAX Alloy - Medical, Dental & Aerospace

- Consistent High-Tolerance Forms for Long Production Runs
- Superb Surface Finishes
- Outstanding Tool Life in Stainless & Titanium
- Special Sizes, Special Tolerances in Less Than 5 Days



M-2 for use with mild steel (HSS)

HassayMAX

for use with stainless, titanium & other high alloy steel

Standard Hexagonal Rotary/Punch Broaches 0.315 Shank

Hex Size (inch)	Across Flats +/- 0.0002	Max. Depth of Cut	OAL Overall Length	EDP No. M-2* Hassay Savage	EDP No. Hassay MAX Hassay Savage
0.051	0.051	1/8	28mm	76002	77002-M
1/16	0.0645	3/16		76004	77004-M
5/64	0.0801	3/16		76005	77005-M
3/32	0.0958	7/32		76006	77006-M
7/64	0.1113	7/32		76007	77007-M
1/8	0.1270	1/4		76008	77008-M
9/64	0.1426	9/32		76009	77009-M
5/32	0.1585	5/16		76010	77010-M
3/16	0.1895	11/32		76012	77012-M
7/32	0.2207	13/32		76014	77014-M
1/4	0.2520	7/16		76016	77016-M

Metric Hexagonal Rotary/Punch Broaches 0.315 Shank

Hex Size (mm)	Across Flats +/- 0.0002	Max. Depth of Cut	OAL Overall Length	EDP No. M-2* Hassay Savage	EDP No. Hassay MAX Hassay Savage
1.5	0.0610	5/32	28mm	762015	772015-M
2.0	0.0807	7/32		76202	77202-M
2.5	0.1004			762025	772025-M
3.0	0.1201	1/4		76203	77203-M
3.5	0.1398			762035	772035-M
4.0	0.1595	5/16		76204	77204-M
4.5	0.1792			762045	772045-M
5.0	0.1989	3/8		76205	77205-M
6.0	0.2382			7/16	76206

This Swiss Style Tooling Designed for Holders on Page 70

SPECIAL ORDERS: We are fully equipped to manufacture custom turned diameters for your exact drill and bore size when repeatable set-ups are required for your job on a continuous basis, for both hex and square applications.

These will all come with the standard lengths and shank diameters of: 8mm, 0.500 and 0.750. Please contact Pilot Precision Products for details.

Index Broaching

Hex and Hexalobe 

An Alternative To Full Form Rotary Broaching

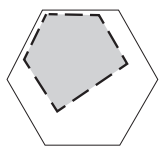

Single Point Hex Broach

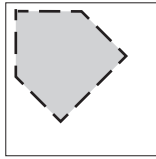

Single Point Square Form



2 Point Hex Index Broach

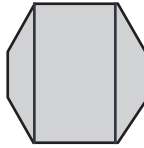

4 Point Index Hex Broach

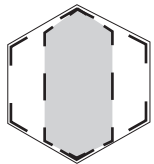

Full 6 Point Hex Form

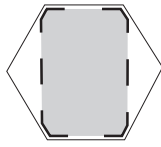

Full 4 Point Hex Form

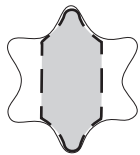

Full 6 Lobe Form



2 Index Lobe Broach

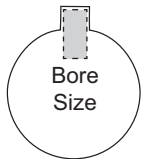

Keyway Shaper

Required Tooling Includes:

- 90° Spot/Chamfer Tool
- Desired Pilot Drill
- Index Punch Broach

Typical Applications Include:

- Hexagonal
- Double Hexagonal
- 6 Lobe / Hexalobe
- Square
- Keyways / Slots / Splines

Index Broaches can be made in the NEW MAX Alloy

HassayMAX

2 or 4 Point Hex Broach Cutting Process

- Hole preparation completed with chamfer & proper pilot hole size
- Machine spindle locked
- Punch enters the work piece, cutting the work piece, then retracts.
- The machine spindle indexes 60° then locks
- The punch enters the work piece a second time, cutting the work piece, then retracts
- Machine spindle indexes 60° then locks
- Punch enters for a third and final imprint
- Drill or boring bar used to make pilot hole can re-enter cut and remove ribbons and chips formed inside the cut



Hex or Square Broach

2 Point Hex Broach Cutting Procedure is effective for broaching materials with higher tensile strength and relieves overall pressure during the process.



4 Point Hex Broach Cutting Procedure is effective for index broaching titanium and stainless steel materials to help improve better tolerances and surface finishes in the finished part.



6 Lobe Hexalobe Broach Cutting Procedures are similar procedures as 2 point or 4 point broach cutting. The process reduces overall pressure, improves tolerances and surface finishes. Ideal for automated production.



Why Hassay Savage Index Broaches?

- For Longer Production Runs
- Superb Surface Finishes
- Outstanding Tool Life in Stainless & Titanium
- Special Sizes, Special tolerances in Less Than 5 Days
- Produce bone screws to ± 0.0002 Tolerance



Adjustable Rotary Broach Holders

Accepts a variety of shapes, such as internal hex & square rotary broaches

Rotary Broach Holders

Use on any type CNC, manual turning, milling or screw machine.

Holder and broaches are sold separately and available from stock for immediate delivery.

For optimal tool life in large production settings these broaches should be used with Rotary Broach Holders.

- The holder has an internal live spindle, which holds the cutting broach tool.
- The centerline of the cutting tool is offset at 1° from the centerline of the work piece.
- This 1° offset causes the broach to wobble, creating a shearing effect as the broach is advanced into the work piece.

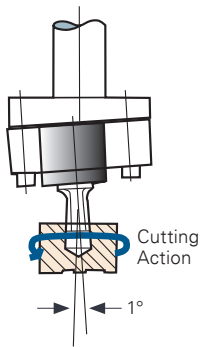
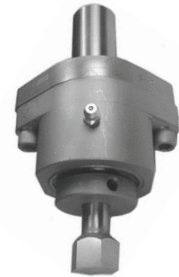

Diagram A
Broaching a Rotating Work Piece

In a turning or screw machine, the holder is mounted stationary while its internal live spindle and the broach rotates after contact with the rotating work piece. At the appropriate feed, the workpiece is sheared by the pressure of the broach through a wobbling type action producing the polygon shape desired.

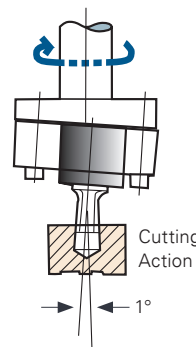

Diagram B
Broaching a Stationary Work Piece

In a vertical milling or drilling machine, the holder is mounted into and rotates with the machine spindle while its internal live spindle along with the broach remains stationary upon contact with the stationary work piece. While the machine spindle is rotating, the broach's pressure shears the polygon shape into the work piece with a wobbling type action.

Adjustable Rotary Broach Holders				
Use with 8mm – 0.315 Broach Shank Diameters				
Overall Length (inch)	Holder Shank Diameter	Holder Shank Length	Broach Shank Depth	EDP No. Hassay Savage
3-27/64	5/8	1-1/2	9/16	P-67040
3-59/64	3/4	2		P-67048S

Adjustable Rotary Broach Holders				
Use with 1/2 – 0.500 Broach Shank Diameters				
Overall Length (inch)	Holder Shank Diameter	Holder Shank Length	Broach Shank Depth	EDP No. Hassay Savage
4-17/32	3/4	2	0.742	P-67048
	1			P-67064
5-17/32	1-1/4	3		P-67068
	1-1/2			P-67072

Heavy Duty Adjustable Rotary Broach Holders				
Use with 3/4 – 0.750 Broach Shank Diameter				
Overall Length (inch)	Holder Shank Diameter	Holder Shank Length	Broach Shank Depth	EDP No. Hassay Savage
7-9/16	1-1/2	3	1.25	P-67072HDS
	1-3/4			P-67076HD

Hassay Savage Internal Rotary Tool Holder Set-Up Procedure

1. Place the Rotary Tool Holder in the Turret (Lathe) or Tool Holder (Milling) depending on the application which fits your needs.
2. Mount the Set Up Plug or Punch Broach in the spindle of the Rotary Tool Holder and take care that the Plug or Punch is bottomed out in the spindle before tightening the set screw on the Holder's Spindle.
3. Drill and Ream a hole to the proper diameter (0.001 larger) for the Set Up Plug in a piece of raw material with a lead chamfer 0.010-0.015 larger than the cross points dimension of the Punch being used. If using the Punch Broach for centering, drill and ream the hole to the diameter of the cross point's dimension.
4. Loosen the 2 cap screws 2-3 turns on the face to generate 3/16 space between the flange portion of the Holder so that it is easily movable in the cup of your hand.
5. Advance the Rotary Tool Holder with the inserted Plug or Punch to 0.030 away from the part while holding the holder flush against the flange.
6. By hand, insert the Plug or Punch into the reamed hole.
7. Advance the turret or tool holder until the holder and tool is fully engaged in the hole.
8. With the Plug or Punch still engaged in the hole, rotate the broach by hand in the hole while tightening the 2 cap screws.
9. Retract the turret or tool holder out of the reamed hole.
10. Remove the set up plug (if using one) and replace with the Punch Broach making sure the Punch Broach is bottomed out in the holder the same as in step 2.
11. See Next Page for Set-Up Plugs.

Swiss-Style Non-Adjustable Holders

High performance results, quality, and consistent tool life that keeps machines running longer

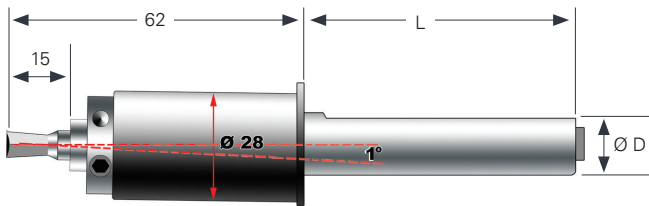
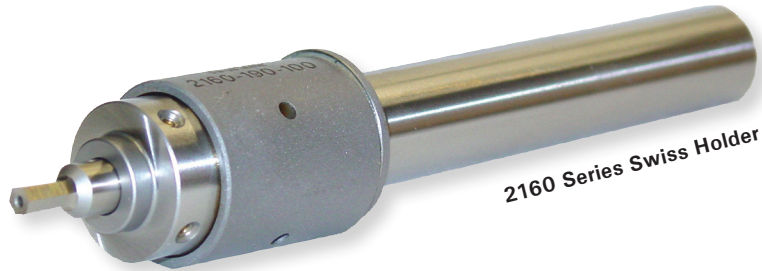

Swiss Style Holders

- No center indicating required – self-centering
- Smaller head diameter eliminates interference on tool blocks
- Longer shank can be cut to proper length
- Short head length for limited back work space
- Built in wobble cutting feature 1° angle
- Heavy duty bearing takes 2,250 lbs. Pushing force
- Swiss made quality high-precision
- Fits most swiss type tool blocks & gang machines
- Excellent for aerospace, medical part / bone screw & dental part production applications
- Recommended profile range for this holder series is 0.050" To 0.375"
- Maintenance-free operation

Swiss Style Holders			
Holds 8mm Shank/Max. Push Force 2,250 lbs.			
D	L	(inch/mm)	EDP No. Hassay Savage
5/8	1-1/2	inch	HSP-2160-158-038
3/4	4		HSP-2160-190-100
1	4-3/4		HSP-2160-254-120
12	38	mm	HSP-2160-120-038
14			HSP-2160-140-038
16			HSP-2160-160-038
20	100		HSP-2160-200-100
22			HSP-2160-220-100
25	120		HSP-2160-250-120

Use Recommendations

Part Preparation

- The diameter of the pre-drilled hole should be larger than the measurement across the flats on the broach.
- Drill the hole 20% deeper than desired depth of cut for chip clearance.
- Countersink with a 90° lead chamfer slightly larger than the largest dimension of the broach face (distance across points) for lead of the broach.

Centering the Broach

The most critical component in running these tools is having the broach centered as close as possible to the centerline of the work piece. Improper centering will cause uneven hole configurations, oversize holes, spiraling, and excessive cutter/holder wear.

- It is necessary to align the end of the broach tool to the centerline of the work piece diameter by means of adjusting the screws located on the sides of the holder, and the use of set-up plugs.
- Alignment instructions are included with purchase of the tool holder.

Speeds and Feeds

Rotational speed (RPM) has a direct effect on cutting speed and tool life.

- Start at 800 RPM with a feed rate of .016 times the size of the broach in inches for a feed rate in IPR units.

Example: The feed rate for a ¼" rotary punch broach would be
 $0.016 \times .250 = .004/\text{rev}$.

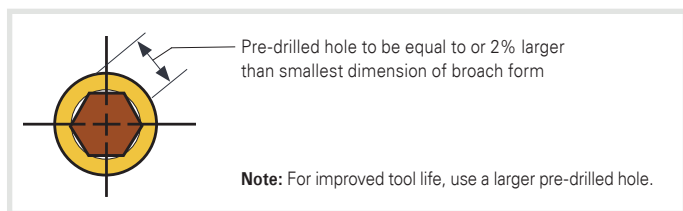

Broach Tool Material

Broaches are customarily manufactured from M-2 high speed steel. This material provides the required edge toughness for standard operations, which do not generate enough heat to effect tool life in machining most metals.

However, for broaching materials such as ductile iron, tool steel, stainless steels, titanium alloys, or nickel-cobalt alloys, a cobalt or MAX Alloy broach would be recommended for optimal tool life. Coatings are also available.

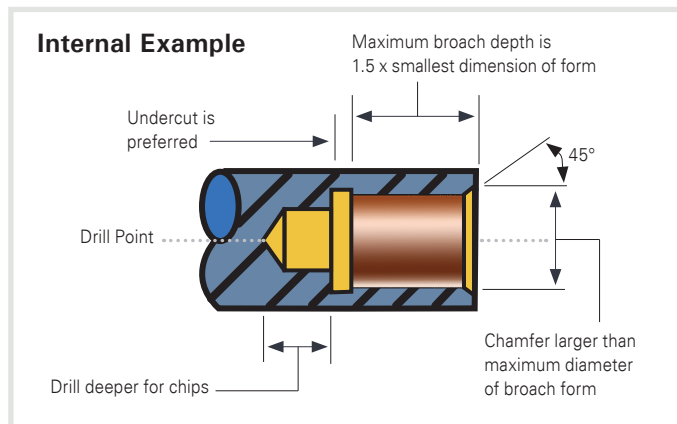

Cutting Principle

- The tool is held at a 1° angle relative to the part centerline.
- The face of the broach tool is the pivot of the 1° angle and is placed on centerline with the part.
- The cutting edge is kept on center and the rest of the tool oscillates around the part centerline with a wobble effect.
- While the faces of the tool and part are at a relative 1° angle, only the leading point of the tool is cutting and not the entire tool profile.
- The wobble effect moves the leading edge to rotate in and out of the cut like a cam.
- It shears the shape into the part with a scalloping effect as it advances forward.
- This reduces the required thrust force up to 80% when it is at the optimum feed.
- Venting can be added to broach to relieve pressure.



Hole Preparation Examples

Hex:
 $B \times 1.02 = \text{Pre-drilled hole, 2% larger}$
 s.c.* = $B \times 1.1547$

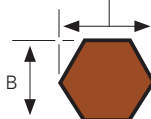

Square:
 $B \times 1.10 = \text{Pre-drilled hole, 10% larger}$
 s.c.* = $B \times 1.4142$



*s.c. = sharp corners

Static Index Punch Broach Holders

These Static Holders can also be used for Full Form Hex Broaches up to 1/4" / 7mm

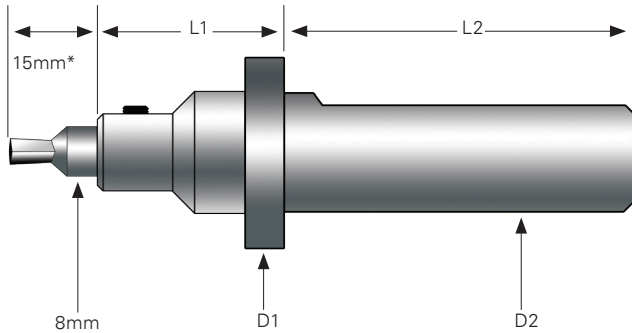

*Only applies when 8mm series broaches are used.



Punch Holders				
D1 (inch)	D2	L1 (inch)	L2 (inch)	EDP No. Hassay Savage
1.00	0.625"	1.25	2.5	HSBH-158250-125-8
	0.750"			HSBH-190250-125-8
	20mm			HSBH-200250-125-8
	22mm			HSBH-220250-125-8
1.10	1.00"			HSBH-254250-125-8

Quick Change ER Collet Punch & Index Broach ER Holder Systems

For Swiss and CNC Machining

When orientation and concentricity of an internal polygon profile is crucial, an ER holder can be used to securely hold a punch or index broach tool and accurately align the tool to center, while ensuring perfect alignment of the profile orientation.

These Quick Change Holders can be preset and reloaded in seconds.

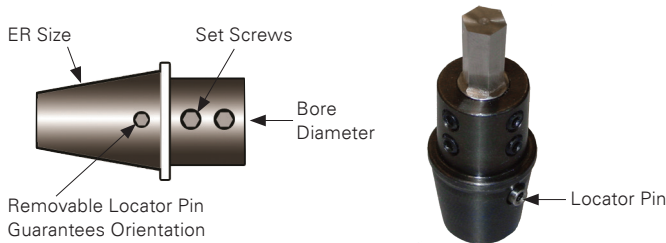

Punch Broach / Boring Adapters & Nuts			
ER Size	Bore Dia.	Nut Thread	EDP No. Hassay Savage
ER16	0.250"	M19 x 1mm Nut & Locator Pin	HSP-PA16-25001
	8mm		HSP-PA16-31501
ER20	0.250"	M24 x 1mm Nut & Locator Pin	HSP-PA20-25001
	8mm		HSP-PA20-31501

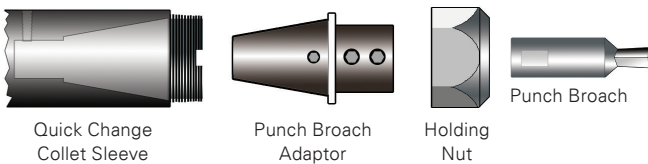

Quick Change Collet Sleeves For Shank Only Holders				
ER Size	D1	L1	OAI	EDP No. Hassay Savage
ER16	0.500"	1.1"	4.5"	HSP-CS16-160500
	0.625"			HSP-CS16-160625
	0.750"			HSP-CS16-160750
	20mm	28mm	71mm	HSP-CS16-160787
	22mm		118mm	HSP-CS16-160866
25mm		95mm	HSP-CS16-160984	
	1"	1.1"	4.5"	HSP-CS16-161000
ER20	0.750"	1.2"		HSP-CS20-200750
	22mm	30mm	114mm	HSP-CS20-200866
	1.00"	1.2"	4.5"	HSP-CS20-201000
	1.250"			HSP-CS20-201250
32mm	30mm	118mm	HSP-CS20-201260	

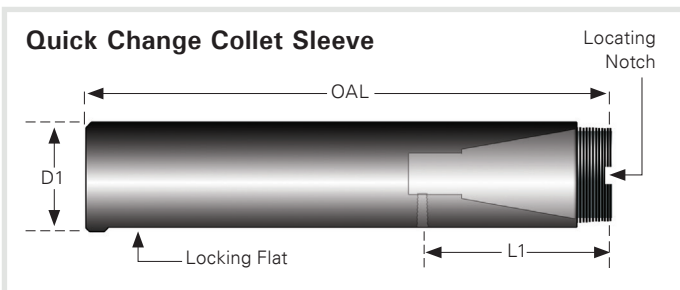

Ultra-Precision Floating Reamer Holders

Complete Orbital Float for True Alignment

Designed with "True Orbital Float" capability, the micro reamer holder aligns the reamer perfectly to the drilled hole, enabling better size control, reduces "bell-mouthing" and increases tool life.

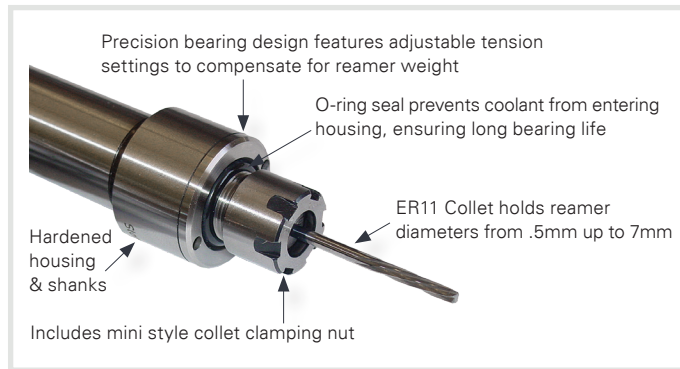
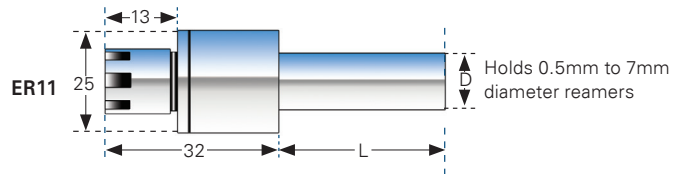
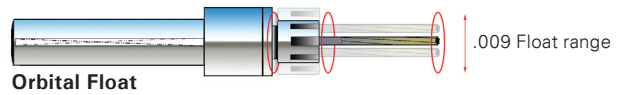

ER11 Floating Reamer Holder w/ Mini-nut Assembly

Item No.	D	L
HSP-11-010-042	10mm	42.00
HSP-11-090-042	3/4 "	2.75"
HSP-11-200-042	20mm	41.50
HSP-11-220-042	22mm	41.50

Accessory Components

Item No.	Description
HSP-04621	ER11 Mini Wrench
HSP-ER-11-MNS	ER11 Mini Nut



Collet Set



Mini Wrench



Mini Nut

Collet Sets

Item No.	Description
HSP-11R-S7-ISP	7pc ER11 Inch bore Collet Set Size Range 1/16, 3/32, 1/8, 5/32, 3/16, 7/32, 1/4"
HSP-11R-S13-MSP	13pc ER11 Metric Bore Collet Set Size Range .5-7mm in .5mm increments
HSP-11R-S13-MUP	13pc ULTRA PRECISION Metric Bore Collet Set (0.0002" TIR) Size Range 0.5-7mm in 0.5mm increments

Advanced Precision Micro Tool Holders

Extreme Concentricity for Micro Drills TIR < .0002"

- High performance
- Tight tolerance
- Micro parts production

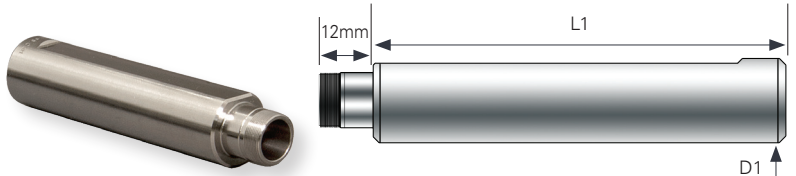

Precision CHK Collets

Item No.	Description
HSP-CHK-1.0	1.0mm CHK Collet
HSP-CHK-1.5	1.5mm CHK Collet
HSP-CHK-2.0	2.0mm CHK Collet
HSP-CHK-2.5	2.5mm CHK Collet
HSP-CHK-3.0	3.0mm CHK Collet
HSP-CHK-3.5	3.5mm CHK Collet



Collet Sleeves

Item No.	Description	D1	L1 (mm)	OAL (mm)
HSP-CHK-127-026	CHK Collet Sleeve 1/2 inch Shank	0.500"	26mm	38mm
HSP-CHK-190-076	CHK Collet Sleeve 3/4 inch Shank	0.750"	76mm	90mm
HSP-CHK-254-121	CHK Collet Sleeve 1 inch Shank	1.00"	121mm	133mm

Note: Includes Clamping Nut and Wrench

Accessory Components

Item No.	Description
HSP-CHK - NUT	Precision CHK Collet Clamping Nut
HSP-CHK 14mm	14mm Flat Wrench



Micro-XL Tool Holders - Micro End Mill Extensions

NEW for 2022

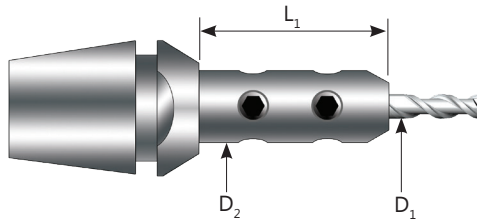

Pair the bore size (D1) to the shank size of the high-quality micro end mill of your choice for maximum reach and rigidity.

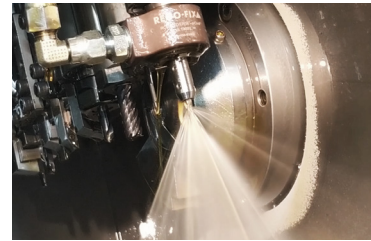

ER8

Item No.	Description	L1	D1	D2
4900-110100	CTE-08-1.00-064100	10	1	6.4
4900-110150	CTE-08-1.50-064100		1.5	6.4
4900-110159	CTE-08-1.59-064100		.062"	6.4
4900-110200	CTE-08-2.00-064100		2	6.4
4900-110300	CTE-08-3.00-070100		3	7
4900-110318	CTE-08-3.18-070100		.125"	7
4900-115100	CTE-08-1.00-064150	15	1	6.4
4900-115150	CTE-08-1.50-064150		1.5	6.4
4900-115300	CTE-08-3.00-070150		3	7
4900-115318	CTE-08-3.18-070150		.125"	7

NOTE: ER8 Holders Include a special M10x.75 clamping nut.

ER11

Item No.	Description	L1	D1	D2
4900-210100	CTE-11-1.00-064100	10	1	6.4
4900-210150	CTE-11-1.50-064100		1.5	6.4
4900-210159	CTE-11-1.59-064100		.062"	6.4
4900-210200	CTE-11-2.00-064100		2	6.4
4900-210300	CTE-11-3.00-080100		3	8
4900-210318	CTE-11-3.18-080100		.125"	8
4900-215300	CTE-11-3.00-080150	15	3	8
4900-215318	CTE-11-3.18-080150		.125"	8
4900-215400	CTE-11-4.00-080150		4	8
4900-220300	CTE-11-3.00-080200	20	3	8
4900-220318	CTE-11-3.18-080200		.125"	8
4900-220400	CTE-11-4.00-080200		4	8

ER16

Item No.	Description	L1	D1	D2
4900-316100	CTE-16-1.00-064160	16	1	6.4
4900-316150	CTE-16-1.50-064160		1.5	6.4
4900-316159	CTE-16-1.59-064160		.062"	6.4
4900-316200	CTE-16-2.00-064160		2	6.4
4900-316300	CTE-16-3.00-095160		3	9.5
4900-316318	CTE-16-3.18-095160		.125"	9.5
4900-316400	CTE-16-4.00-095160		4	9.5
4900-316476	CTE-16-4.76-095160		.187"	9.5
4900-316500	CTE-16-5.00-095160		5	9.5
4900-325300	CTE-16-3.00-095250	25	3	9.5
4900-325300C	CTE-16-3.00-095250C		3	9.5
4900-325318	CTE-16-3.18-095250		.125"	9.5
4900-325318C	CTE-16-3.18-095250C		.125"	9.5
4900-325400	CTE-16-4.00-095250		4	9.5
4900-325476	CTE-16-4.76-095250		.187"	9.5
4900-325500	CTE-16-5.00-095250		5	9.5

*

*

* Coolant-Thru Version

ER25

Item No.	Description	L1	D1	D2
4900-525300	CTE-25-3.00-100250	25	3	10
4900-525318	CTE-25-3.18-100250		.125"	10
4900-525400	CTE-25-4.00-100250		4	10
4900-525476	CTE-25-4.76-125250		.187"	12.5
4900-525500	CTE-25-5.00-125250		5	12.5
4900-525600	CTE-25-6.00-125250		6	12.5
4900-525635	CTE-25-6.35-125250		.250"	12.5
4900-525700	CTE-25-7.00-160250		7	16
4900-525794	CTE-25-7.94-160250		.312"	16
4900-525800	CTE-25-8.00-160250		8	16

ER20

Item No.	Description	L1	D1	D2
4900-414300	CTE-20-3.00-095140	14	3	9.5
4900-414476	CTE-20-4.76-114140		.187"	11.4
4900-414500	CTE-20-5.00-114140		5	11.4
4900-414600	CTE-20-6.00-125140		6	12.5
4900-414635	CTE-20-6.35-125140		.250"	12.5
4900-416318	CTE-20-3.18-095160	16	.125"	9.5
4900-416400	CTE-20-4.00-095160		4	9.5
4900-416476	CTE-20-4.76-114160		.187"	11.4
4900-425300	CTE-20-3.00-095250	25	3	9.5
4900-425318	CTE-20-3.18-095250		.125"	9.5
4900-425400	CTE-20-4.00-095250		4	9.5
4900-425476	CTE-20-4.76-114250		.187"	11.4
4900-425500	CTE-20-5.00-114250		5	11.4
4900-425600	CTE-20-6.00-125250		6	12.5
4900-425635	CTE-20-6.35-125250		.250"	12.5

Collet Reduction

NOW AVAILABLE!

Item No.	Description	Shank Size	Collet Size	Extension Length
Call For Details	RTE-16-08-100254	ER16	ER8	1.0 in

Replacement Stop Screws

Item No.	Size	Fits
8999-000021	M6	ER11
8999-000206	M8	ER16 & 20
8999-000210	M10	ER25



Replacement Set Screws

Item No.	Size
8999-000011	M3
8999-000007	M4
8999-000214	M5





High-Performance
Round Cutting Tools

PILLOT

Table of Contents

Introduction	77
Index	78
Centering – Spotting – Combined Machining	
Plain Type 60° HSS & Cobalt Center Drills	79
ASA Carbide 60°, 82°, 90° HSS Long Center Drills	80
Radius Type, Form R HSS Center Drills	81
Bell Type HSS Center Drills	81
Unique Center Drills with Reinforcing Bulge, Form W	82
Metric Center Drills	83-85
Short & Long NC Spotting Drills, Angle 90°, 118°, 120°	86
NC Spotting Drills, Angle 60°, 90°, 120°	87
NC Spotting Drills, Angle 90°, 120°, 142°	88
duoMAG Double Ended NC Spotting Drills	89
Multi-Function Tools	
Micro & Multi-Function Tools “Multi-V” Carbide 40° & 60°	90
Multi-V Carbide 90°, 100° & 120°	91
Speeds & Feeds for Multi-V	92
Bi-Face Chamfering Biconical Cutters	93
Single Flute/Point Interpolated Thread Milling Cutters	94
Multi-Function Carbide Miniature Tools	94
Countersinking	
Trident Imperial Three Flute Countersinks Cobalt 30°, 60°, 82°, 90°, 100° & 120°	95-96
Trident Metric 60° and 82° Three Flute Countersinks	97
Trident Metric 90° Three Flute Countersinks	98
Trident Metric 90° Three Flute Countersinks Anti-Vibration	99
Single Flute Chamfering Cutters Cobalt 60°, 82°, 90°, 100°, 120°	100-101
60° & 82° Zero Flute Deburring Tool with Hole	102
Speeds & Feeds for Deburring, Chamfering & Three Flute Countersinks	103
Trident Hand Countersinks	104
Auto Body Drill Bits to Disconnect Spot Welds	105
High Precision Micro & Miniature Reamers	
Reamer Information	106
Reamer with Coolant thru for Blind Holes	107
High Precision Carbide Micro-Reamers	108
High Precision 8600 Miniature Reamers	109-114
Reamer Formulas for Speeds & Feeds	115
Reamer Hole Size Chart & 220° Ball-End Miniature End-Mills with Back Clearance	116
Micro End-mills	
High Performance Micro-Milling	117
Standard & Long Length Miniature End-mills	118-119
Extra-Long Carbide End-mills & Miniature End-mills with Back Clearance	120
Microforce Speeds & Feeds for End-mills	121

Custom Solutions Are Standard



Magafor

Magafor is the recognized world leader in the production of precision tools. Pilot is proud to be the exclusive American distributor of such fine products.

Specialization

With more than 250 product groups and over 8,000 standard products, Magafor offers the solution adapted to each of your machining applications. For example, the 0.40mm diameter micro end-mill is available in 26 different lengths and styles. You'd be hard-pressed to find a manufacturer offering more options. Styles, materials and lengths vary within each specific range of tooling to offer you the widest selection.

Innovation

Magafor meets the needs of even the most demanding customers by: detecting customer needs to create new technologies; analyzing and comparing the totality of the special tools; and comparing market trends to create custom solutions.

Trial & Test Standard Tools

Magafor is so confident in the performance and reliability of its products—as are we!—that we'll extend the most liberal trial program in the industry. At your request, we'll provide standard test tools FREE of charge. Contact customer service with any questions and to facilitate this request.

Blanket Orders

Please know that we accept and encourage blanket orders on standard stock items, standard non-stock items and custom items. We will always ensure continuous delivery with large safety stock levels.

Specials

Magafor excels in manufacturing custom tooling and delivering solutions that show cost savings in most applications.

Coatings

In addition to Futura and TiN coatings, three new "X" coatings, sprung from multi-layer nano technology are available:

Red'X:

Cobalt tool coating has a higher hardness of (3700 HV) and is similar to TiAlN in a multi-layer coating. Choose this coating for dry machining. Using coolant will add lubricity.

Hard'X:

Carbide tool coating has a high hardness (3500 HV) and shows a high thermic stability. It offers excellent protection against heat and wear and is ideal for dry-machining high-speed cut-in treated steels and dies up to 67 Rc.

Graph'X:

Diamond coating (8000 HV) is particularly effective when machining graphite, composite materials, plastics with glass-fibers or carbon-fibers.

Note: Vickers Hardness Test

HV = a unit of hardness given by the test known as the Vickers Pyramid Number



Magafor is the only cutting tool manufacturer member of the European Commission that has been chosen to research micro-machining.

This research targets performance improvements of all Magafor tools, ensuring customers the greatest profit margins.

Materials Used in the Manufacture of Our Tools and Coatings Designation			
Designation			
Magafor	European	American	Japanese
HSS	HSS	M2	SKH-51
HSS-E COBALT	HSS-E	M35	SKH-55
HSS-E 8% COBALT	HSS-E8	M42	SKH-59
TiN	TiN	TiN	TiN
Futura	TiAlN	TiAlN	TiAlN
Red'X	TiAlN with higher hardness (3700 HV)		
Hard'X	AlTiN	Latuma	
Graph'X	Diamond coating		
K15 CARBIDE — 6.5 – 7% Cobalt (0.006 – 0.008mm grain size)			

Engaged right from the start in the process aspiring to excellence, in addition to our Futura and TiN coatings, Magafor offers three “X” coatings, sprung from multi-layer nano technology.

Red'X Cobalt tool coating has a higher hardness of (3700 HV) and is similar to TiAlN in a multi-layer coating. Choose this coating for dry machining. Using coolant will add lubricity.

Hard'X [For hard milling] carbide tool coating has a high hardness (3500 HV) and shows a high thermic stability. It offers excellent protection against heat and wear and is ideal for dry machining-high speed cut-in treated steels and dies up to 67 HRC.

Graph'X [For composite milling] diamond coating (8000 HV) is particularly effective when machining graphite, composite materials, plastics with glass-fibers or carbon-fibers.



Hardness and Use for Materials							
Material	HSS	HSS-Co	HSS-Co + TiN	HSS 8% Co	HSS 8% Co + Red'X	CARBIDE	CARBIDE + Hard'X
Hardness	63 HRC	65 HRC	65 HRC + 2300 HV	67 HRC	67 HRC + 3500 HV	1800HV	1800HV + 3500
Use	Small Series	Production intensive		Hard and abrasive alloys		Treated steel	

Note: Vickers Hardness Test HV = a unit of hardness given by the test known as the Vickers Pyramid Number

EDP Numbering System

EDP # 88860001810 - 1.81 mm
Solid Carbide High Precision
Micro Reamer

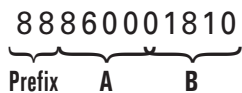

- A** = Series # - 8600
Series # 8600 refers to Solid Carbide High Precision Micro Reamers
- B** = Size - 1.81 mm
Size 01810 refers to 1.81 mm

Series Index									
Code	Page	Code	Page	Code	Page	Code	Page	Code	Page
019	88	202	105	4835	96	8197	87	8527	117
019-L	89	203	105	4837	104	8199	87	8527-H	117
0290	84	2901	105	4839	95	8201	105	8550	94
0811	83	2903	105	4933	98	8203-H	105	8550-H	94
08115	79	43-A	99	4936	98	8431	98	8600	109
0890	84	411	102	8008-A	86	8431-H	98	8610	106
0895	87	421	100	8008-B	86	8431-L	98	8670	107
0896	87	422	101	8008-C	86	8432	97		
0910	83	423	100	8008-D	86	8434	97		
0915	79	425	100	8040	90	845-H	94		
0919	89	430	104	8088	90	8460	93		
0919-L	89	4303	98	8088-H	90	8460-H	93		
0995	87	431	98	8090	91	8480	93		
0996	87	432	95	8090-H	91	8480-H	93		
10	83	433	96	8092	91	8490	93		
105	83	434	95	8092-H	91	8490-H	93		
11	84	435	96	8095	91	8500	118		
1055	79	436	98	8095-H	91	8500-G	118		
115	79	437	104	8100	83	8500-H	118		
125	81	438	104	8100-H	83	8507	120		
135	81	439	95	8105	80	8507-H	120		
145	82	4811	102	8105-H	80	8507-D	120		
154	80	4821	100	8119-A	86	8507-DG	120		
155	80	4822	101	8119-B	86	8507-DH	120		
185	80	4823	100	8119-C	86	8509	119		
191	87	4825	100	8119-D	86	8509-G	119		
195	87	483-A	99	8190-H	86	8509-H	119		
196	87	4831	99	8195	88	8510	120		
197	87	4832	95	8195-H	88	8510-G	120		
199	87	4833	96	8196	88	8510-H	120		
201	105	4834	95	8196-H	88	8522-H	116		

Center Drills

Plain Type 60°

Applications: **Centering, Spotting and Combined Machining**

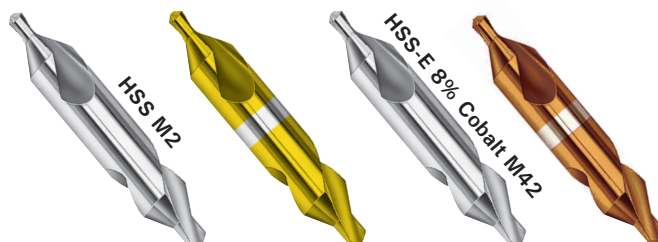
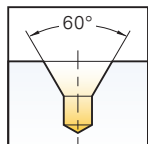

Plain Center Drills - Angle 60°

Size	D	d	L	/	115	M2/TiN 08115	Cobalt + 1055	M42/Red'X 0915
00000	1/8	0.010	1-1/4	0.008 - 0.018	8111500A000*	800811500A0	81105500A00*	80091500A00*
0000		0.015		0.014 - 0.025	8111500B000*	800811500B0	81105500B00*	80091500B00*
000		0.020		0.020 - 0.032	8111500C000	800811500C0	81105500C00*	80091500C00*
00		0.025		0.028 - 0.040	8111500D000	800811500D0	81105500D00*	80091500D00*
0		1/32		0.035 - 0.047	8111500E000	800811500E0	81105500E00*	80091500E00*
1	1/8	3/64	1-1/4	0.055 - 0.067	81115010000	80081150100	81105501000	80091501000
2	3/16	5/64	1-7/8	0.095 - 0.106	81115020000	80081150200	81105502000	80091502000
3	1/4	7/64	2	0.130 - 0.154	81115030000	80081150300	81105503000	80091503000
4	5/16	1/8	2-1/8	0.150 - 0.175	81115040000	80081150400	81105504000	80091504000
4-1/2	3/8	9/64	2-1/2	0.170 - 0.193	81115045000	80081150450	-	-
5	7/16	3/16	2-3/4	0.230 - 0.256	81115050000	80081150500	81105505000	80091505000
6	1/2	7/32	3	0.270 - 0.295	81115060000	80081150600	81105506000	80091506000
7	5/8	1/4	3-1/4	0.315 - 0.340	81115070000	80081150700	81105507000	80091507000
8	3/4	5/16	3-1/2	0.390 - 0.420	81115080000	80081150800	81105508000	80091508000
9	7/8	11/32	3-5/8	0.430 - 0.460	81115090000	80081150900	-	-
10	1	3/8	3-3/4	0.475 - 0.500	81115100000	80081151000	-	-

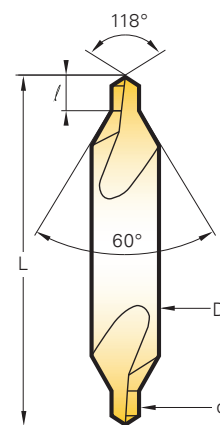

*Single end tool

Tolerances

Tool Diameters	D	d	Angle	
			60°	118°
.010 - 7/64	n/a	+ .0039	-	-
1/8 - 7/32	-0.0007	+ .0047	-	-
1/4 - 3/8	-0.0009	+ .0059	-	-
7/16 - 5/8	-0.0011	+ .0059	-30'	± 2°
3/4 - 1	-0.0013	+ .0059	-	-

Concentricity of Drill Diameter to Body is: +/- .0005 runout



American Standard Value Sets

Composition Quantity	15 Pieces HSS 81115000015	Composition Quantity	HSS 81115000000	Composition Quantity	5 Pieces Cobalt 81105500000
3 pieces each	# 1	1 piece each	# 1	1 piece each	# 1
	# 2		# 2		# 2
	# 3		# 3		# 3
	# 4		# 4		# 4
2 pieces	# 4-1/2		# 5		# 5
1 piece	# 5				

Sets also available TiN coated

Center Drills

Plain Type 60°, 82°, 90° and Longs

Applications: **Centering**

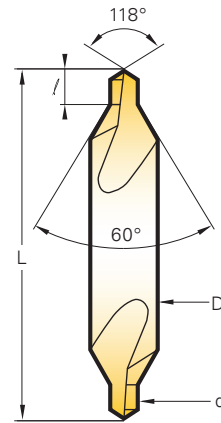
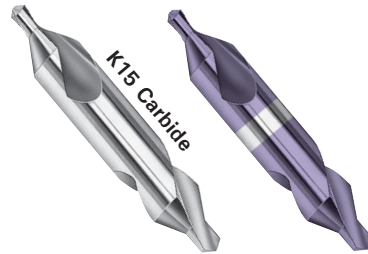

ASA Solid Carbide Plain Center Drills - Angle 60°						
Size	D	d	L	/	K15 Carbide 8105	Hard'X 8105-H
00	1/8	0.025	1-1/4	0.020 - 0.040	88810500D00	888105H00D0
0	1/8	1/32	1-1/4	0.035 - 0.047	88810500E00	888105H00E0
1	1/8	3/64	1-1/4	0.055 - 0.067	88810501000	888105H0100
2	3/16	5/64	1-7/8	0.095 - 0.106	88810502000	888105H0200
3	1/4	7/64	2	0.130 - 0.154	88810503000	888105H0300
4	5/16	1/8	2-1/8	0.150 - 0.175	88810504000	888105H0400
5	7/16	3/16	2-3/4	0.230 - 0.256	88810505000	888105H0500
6	1/2	7/32	3	0.270 - 0.295	88810506000	888105H0600

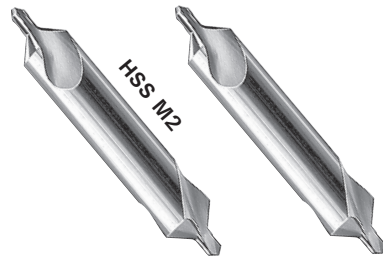
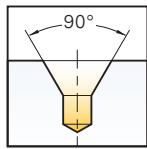
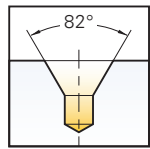

Plain Center Drill - Angles 82° and 90°						
Size	D	d	L	/	Angle 82° 154	Angle 90° 155
1	1/8	3/64	1-1/4	0.055 - 0.067	81154010000	81155010000
2	3/16	5/64	1-7/8	0.095 - 0.106	81154020000	81155020000
3	1/4	7/64	2	0.130 - 0.154	81154030000	81155030000
4	5/16	1/8	2-1/8	0.150 - 0.175	81154040000	81155040000
5	7/16	3/16	2-3/4	0.230 - 0.256	81154050000	81155050000
6	1/2	7/32	3	0.270 - 0.295	81154060000	81155060000
7	5/8	1/4	3-1/4	0.135 - 0.340	81154070000	81155070000
8	3/4	5/16	3-1/2	0.390 - 0.420	81154080000	81155080000

Longs - Angle 60°				
Size (inch)	D	d	L	HSS M2 185
1 x 3	1/8	3/64	3	81185010300
1 x 4			4	81185010400
1 x 5			5	81185010500
1 x 6	3/16	5/64	6	81185010600
2 x 3			3	81185020300
2 x 4			4	81185020400
2 x 5	1/4	7/64	5	81185020500
2 x 6			6	81185020600
3 x 3			3	81185030300
3 x 4	5/16	1/8	4	81185030400
3 x 5			5	81185030500
3 x 6			6	81185030600
4 x 3	3/8	9/64	3	81185040300
4 x 4			4	81185040400
4 x 5			5	81185040500
4 x 6	7/16	3/16	6	81185040600
4-1/2 x 4			4	81185045400
4-1/2 x 5			5	81185045500
4-1/2 x 6	1/2	7/32	6	81185045600
5 x 4			4	81185050400
5 x 5			5	81185050500
5 x 6	5/8	1/4	6	81185050600
6 x 4			4	81185060400
6 x 5			5	81185060500
6 x 6	3/4	5/16	6	81185060600
7 x 5			5	81185070500
7 x 6			6	81185070600
8 x 6			6	81185080600



American Standard Value Sets - Angle 60°	
5 Pieces / 4" OAL Long	
Composition	81185000000
1 piece each	# 1 Long # 2 Long # 3 Long # 4 Long # 5 Long

Center Drills

Radius Type, Form R

Applications: **Centering**

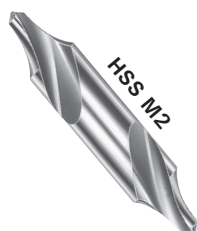

Magafor center drills with radius have a special profile and offer the following benefits over a 60° center drill:

- The radii eliminates the risk of breakage
- They provide an exact bearing
- They serve as a protective chamfer

Center Drills Radius Type Form R						
ASA #	D	d	L	R	/	HSS M2 125
1 - R	1/8	3/64	1-1/4	0.150	0.125 - 0.150	81125010000
2 - R	3/16	5/64	1-7/8	0.230	0.200 - 0.225	81125020000
3 - R	1/4	7/64	2	0.315	0.270 - 0.300	81125030000
4 - R	5/16	1/8	2-1/8	0.400	0.340 - 0.370	81125040000
5 - R	7/16	3/16	2-3/4	0.500	0.480 - 0.510	81125050000
6 - R	1/2	7/32	3	0.530	0.540 - 0.575	81125060000
7 - R	5/8	1/4	3-1/4	0.700	0.660 - 0.700	81125070000
8 - R	3/4	5/16	3-1/2	0.790	0.810 - 0.850	81125080000

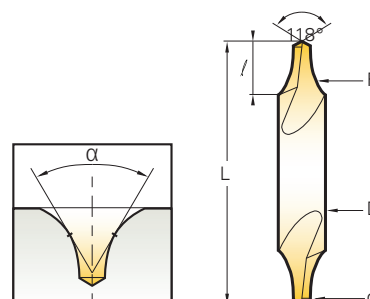

Tolerances			
Tool Diameters	D	d	R max
.010 - 7/64	-0.0007	+ 0.0039	-
1/8 - 7/32	-0.0007	+ 0.0047	-
1/4 - 3/8	-0.0009	+ 0.0059	1.25 R
7/16 - 5/8	-0.0011	n/a	-
3/4 - 1	-0.0013	n/a	-

American Form R Standard Sets	
Composition Quantity	5 Pieces 81125000000
1 piece each Radius Type	# 1 - R # 2 - R # 3 - R # 4 - R # 5 - R



Center Drills

Bell Type, Form B

Center drills with protective chamfer guarantee the center obtained from any risk of blows and deformation. The splay resulting from the protective chamfer makes it easier to load parts between points on machines with automatic feed.

Bell Type w/Saved Angle Form B						
Size	D	d	K	L	/	HSS M2 135
11	1/8	3/64	0.100	1-1/4	0.055 - 0.070	81135110000
12	3/16	1/16	0.150	1-7/8	0.707 - 0.090	81135120000
13	1/4	3/32	0.200	2	0.110 - 0.135	81135130000
14	5/16	7/64	0.250	2-1/8	0.125 - 0.155	81135140000
15	7/16	5/32	0.350	2-3/4	0.185 - 0.215	81135150000
16	1/2	3/16	0.400	3	0.230 - 0.260	81135160000
17	5/8	7/32	0.500	3-1/4	0.270 - 0.300	81135170000
18	3/4	1/4	0.600	3-1/2	0.310 - 0.340	81135180000
19	7/8	5/16	0.700	3-5/8	0.390 - 0.420	81135190000
20	1	3/8	0.800	3-3/4	0.470 - 0.500	81135200000

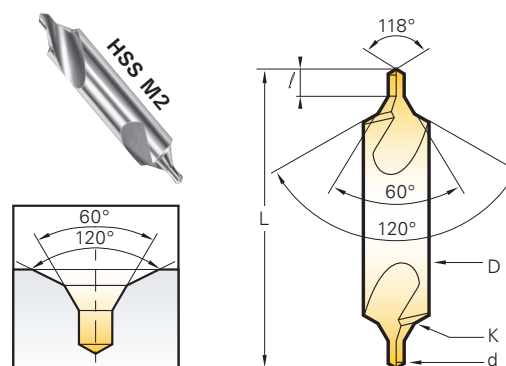

Tolerances					
Tool Diameters	D	d	60°	Angle 118°	120°
.010 - 7/64	-0.0007	+ 0.0039	-	-	-
1/8 - 7/32	-0.0007	+ 0.0047	-	-	-
1/4 - 3/8	-0.0009	+ 0.0059	-30'	± 2°	-4°
7/16 - 5/8	-0.0011	-	-	-	-
3/4 - 1	-0.0013	-	-	-	-

American Standard Form B Sets	
Composition Quantity	81135000000
1 piece each Bell Type	# 11 # 12 # 13 # 14 # 15



Unique Center Drills

With Reinforcing Bulge, Form W



Magafor center drill form W is stronger than the common center drill:

- The bulge reinforces the point
- It increases the chips removal
- It makes the lubrication of the drill easier
- It runs at faster speeds and feeds

Plain Center Drills w/Bulge Form W

ASA #	D	d	L	/	HSS M2 145
1 - W	1/8	6/64	1-1/4	0.055 - 0.067	81145010000
2 - W	3/16	5/64	1-7/8	0.094 - 0.106	81145020000
3 - W	1/4	7/64	2	0.130 - 0.154	81145030000
4 - W	5/16	1/8	2-1/8	0.150 - 0.175	81145040000
5 - W	7/16	3/16	2-3/4	0.230 - 0.256	81145050000
6 - W	1/2	7/32	3	0.270 - 0.295	81145060000
7 - W	5/8	1/4	3-1/4	0.315 - 0.340	81145070000
8 - W	3/4	5/16	3-1/2	0.390 - 0.420	81145080000

Tolerances

Tool Diameters	D	d	Angle	
			60°	118°
.010 - 7/64	-0.0007	+ 0.0039	-	-
1/8 - 7/32	-0.0007	+ 0.0047	-	-
1/4 - 3/8	-0.0009	+ 0.0059	-30'	± 2°
7/16 - 5/8	-0.0011	n/a	-	-
3/4 - 1	-0.0013	n/a	-	-

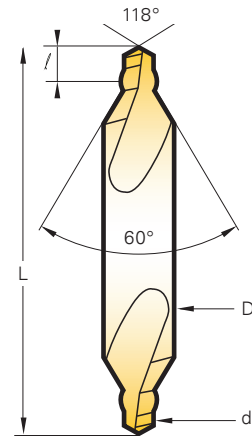
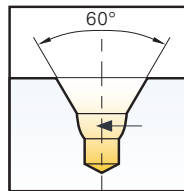

American Standard Form W Sets

Composition Quantity	81145000000
1 piece each Bulge	# 1 - W # 2 - W # 3 - W # 4 - W # 5 - W

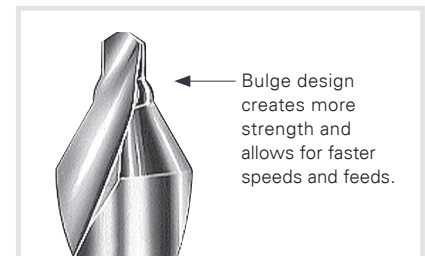

To place an order or to learn more about Pilot Precision Products, contact customer service at 413-350-5200.

Metric Center Drills

Angle 60°

Applications: **Centering**

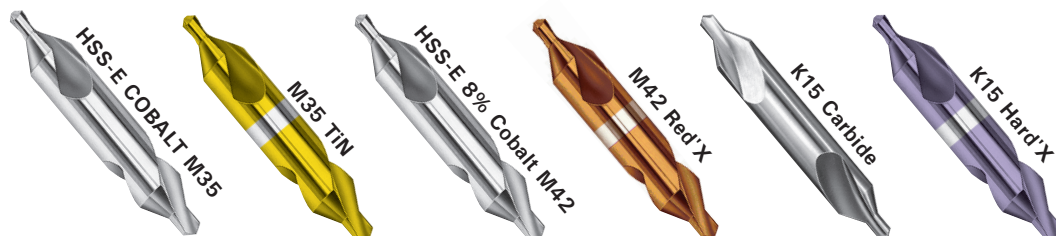

Plain Center Drills - Angle 60° ISO - NFE 66051-A - DIN 333-A - JIS-1

D x d	L	/	Cobalt M35 10	HSS-E M35 TiN 0811	HSS-E 8% Cobalt M42 105	M42/Red'X 0910	Carbide 8100	K15/Hard'X 8100-H
3.15 x 0.5*	25	0.6 – 0.9	-	80081103105	-	-	88810003105	888100H031505
3.15 x 0.8*		1.0 – 1.3	-	80081103108	-	-	88810003108	888100H031508
3.15 x 1.0	31	1.3 – 1.7	81100315100	80081103151	81105031510	80091003151	88810003151	888100H03151
3.15 x 1.25		1.6 – 2.0	81100315125	80081103125	81105031512	80091003125	88 810003125	888100H0315125
3.5 x 0.75	35	1.0 – 1.3	81100350750	800811035075	-	-	-	-
4.0 x 1.0		1.3 – 1.7	81100410000	80081104100	-	-	88810004100	888100H0410
4.0 x 1.6		2.0 – 2.6	81100416000	80081104160	81105041600	80091004160	88810004160	888100H0416
5.0 x 1.5	40	2.0 – 2.6	81100515000	80081105150	-	-	88810005150	888100H0515
5.0 x 2.0		2.5 – 3.1	81100520000	80081105200	81105052000	80091005200	88810005200	888100H0520
6.0 x 2.0	45	2.5 – 3.1	81100620000	80081106200	-	-	88810006200	888100H0620
6.3 x 2.5		3.1 – 3.8	81100632500	80081106325	81105063250	80091006325	88810006325	888100H06325
8.0 x 2.5		3.1 – 3.8	81100825000	80081108250	-	-	88810008250	888100H0825
8.0 x 3.0	50	3.9 – 4.6	81100830000	80081108300	-	-	88810008300	888100H0830
8.0 x 3.15		3.9 – 4.6	81100831500	80081108315	81105083150	80091008315	88810008315	888100H08315
10.0 x 3.0	55	3.9 – 4.6	81101030000	80081110300	-	-	88810010300	888100H1030
10.0 x 4.0		5.0 – 5.9	81101040000	80081110400	81105104000	80091010400	88810010400	888100H1040
12.0 x 4.0	63	5.0 – 5.9	81101240000	80081112400	-	-	-	-
12.0 x 5.0		6.3 – 7.2	81101250000	80081112500	-	-	88810012500	888100H1250
12.5 x 5.0		6.3 – 7.2	81101255000	80081112550	81105125500	80091012550	88810012550	888100H1255
14.0 x 5.0	69	6.3 – 7.2	81101450000	800811150450	-	-	-	-
16.0 x 6.3	71	8.0 – 8.9	-	80081116630	-	-	88810016630	888100H1663
20.0 x 8.0	80	10.1 – 11.1	-	80081120800	-	-	-	-

*Single end K15 Carbide — 6.5 – 7% Cobalt (0.006 – 0.008mm grain size)



The largest manufacturer of center drills worldwide,
with over 4 million units sold annually.

Metric Center Drills

Angle 60°, Form A

Applications: **Centering**

Magafor center drills are particularly effective thanks to their unique ground spiral flutes. Special attention to the concentricity of the drill diameter to body makes them superior to other offerings on the market.

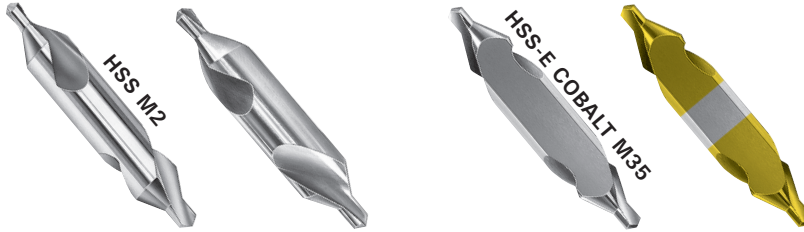

Metric Center Drills Form A - Angle 60°							
D x d	L	/	Right Hand HSS M2 11	Left Hand HSS M2 16	P -0.1	With flat, right hand HSS-E M35 Cobalt 0290	HSS-E M35 TiN 0890
3.0 x 0.5	31	0.6 – 0.9	81110305000	-	-	-	-
3.15 x 0.5*	25	0.6 – 0.9	81110315050	81160315050	-	-	-
3.15 x 0.63*		0.7 – 0.9	81110315063	81160315063	-	-	-
3.15 x 0.8*		1.0 – 1.3	81110315080	81160315080	-	-	-
3.15 x 1.0	31	1.3 – 1.7	81110315100	81160315100	-	-	-
3.15 x 1.25		1.6 – 2.0	81113151250	81160315125	-	-	-
3.5 x 0.75	35	1.0 – 1.3	81110350750	81160350750	-	-	-
4.0 x 1.0		1.3 – 1.7	81110410000	81160410000	-	-	-
4.0 x 1.25		1.6 – 2.0	81110412500	81160412500	-	-	-
4.0 x 1.6		2.0 – 2.6	81110416000	81160416000	3.25	80029004160	80089004160
5.0 x 1.5	40	2.0 – 2.6	81110515000	81160515000	-	-	-
5.0 x 1.6		2.0 – 2.6	81110516000	81160516000	-	-	-
5.0 x 2.0		2.5 – 3.1	81110520000	81160520000	4.20	80029005200	80089005200
6.0 x 2.0	45	2.5 – 3.1	81110620000	81160620000	-	-	-
6.3 x 2.0		2.5 – 3.1	81110632000	81160632000	-	-	-
6.3 x 2.5		3.1 – 3.8	81110632500	81160632500	5.35	80029006325	80089006325
8.0 x 2.5	50	3.1 – 3.8	81110825000	81160825000	-	-	-
8.0 x 3.0		3.9 – 4.6	81110830000	81160830000	-	-	-
8.0 x 3.15		3.9 – 4.6	81110831500	81160831500	6.96	80029008315	80089008315
10.0 x 3.0	55	3.9 – 4.6	81111030000	81161030000	-	-	-
10.0 x 3.15		3.9 – 4.6	81111031500	81161031500	-	-	-
10.0 x 4.0		5.0 – 5.9	81111040000	81161040000	8.40	80029010400	80089010400
12.0 x 4.0	63	5.0 – 5.9	81111240000	81161240000	-	-	-
12.0 x 5.0		6.3 – 7.2	81111250000	81161250000	-	-	-
12.5 x 4.0		5.0 – 5.9	81111254000	81161254000	-	-	-
12.5 x 5.0	69	6.3 – 7.2	81111255000	81161255000	10.95	80029012550	80089012550
14.0 x 5.0		6.3 – 7.2	81111450000	81161450000	-	-	-
16.0 x 5.0	71	6.3 – 7.2	81111650000	81161650000	14.00	80029016630	80089016630
16.0 x 6.3		8.0 – 8.9	81111663000	81161663000	-	-	-
18.0 x 6.0	77	8.0 – 8.9	81111860000	-	-	-	-
20.0 x 6.3	80	8.0 – 8.9	81112063000	-	-	-	-
20.0 x 8.0		10.1 – 11.1	81112080000	81162080000	17.90	80029020800	-
25.0 x 8.0	100	10.1 – 11.1	81112580000	-	-	-	-
25.0 x 10.0		12.8 – 13.8	81112510000	-	-	22.50	80029025100
31.5 x 10.0	125	12.8 – 13.8	81113151000	-	-	-	-
31.5 x 12.5		16.5 – 17.5	81113151250	-	-	-	-

*Single end

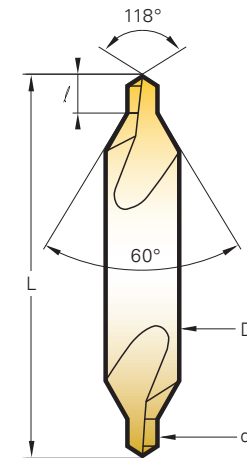
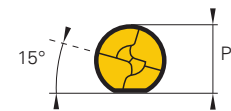
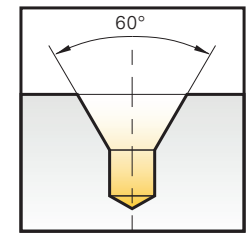

Tolerances				
D	d	L	60°	118°
h8	K12	± 1	-30°	± 2°

Performance

Recommendations for the use of Center Drills and NC Spot Drills

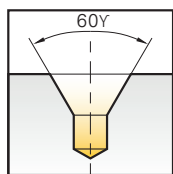

Form A

- The most universal center drill
- 60° angle
- Standard center
- 118° point

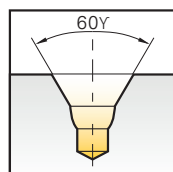

Form W

- The bulge reinforces the point
- Increases chip removal
- Makes the lubrication of the drill easier
- 118° point

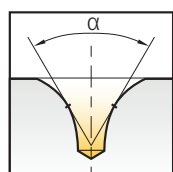

Form R

- The radius eliminates the risk of breakage, and is more robust than the 60° drill
- Provides an exact bearing surface
- Serves as a protective chamfer
- 118° point

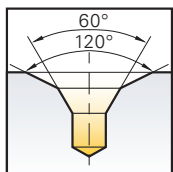

Form B

- Center drill with protective chamfer guarantees the center from any risk of blows and deformation
- 118° point

SFM: Surface Feet per Minute

RPM: Revolutions per Minute

IPM: Inches per Tooth (chip load)

IPM: Inches per Minute

IPR: Inches per Revolution

Speed Formula:

$$RPM = 3.82 \times (SFM \div \text{Diameter})$$

Feed:

$$IPM = IPT \times \# \text{ of Flutes} \times RPM$$

$$IPR = IPM \div RPM$$

$$SFM = RPM \times \text{Diameter} \div 3.82$$

Formula for Speed (RPM)

Example:

#1 center drill (.078) cutting soft material <81 HRB

SFM = 148 for 5/64Ø HSS

$$RPM = 3.82 \times (148 \div 0.0787) = 14.36$$

$$IPM = 0.001 \times 2 \times 7180 = 14.36$$

$$IPR = 14.36 \div 7180 = .002$$

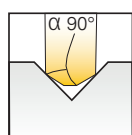

90° NC Spot Drill Centering and chamfering are obtained in a single operation.

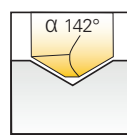
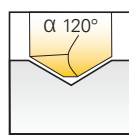

120° & 142° NC Spot Drill The preliminary hole corresponds to the angle at the end of the tool used in drilling and prevents it from deviating.

Material		HSS					TiN						
		SFM	Feed Inch/Rev					SFM	Feed Inch/Rev				
			2 mm 5/64	3 mm 1/8	6 mm 1/4	10 mm 3/8	16mm 5/8		2 mm 5/64	3 mm 1/8	6 mm 1/4	10 mm 3/8	16mm 5/8
Steel:	< 81 HRB (B)	99 – 148						197 – 296					
	< 24 Rc (C)	82 – 99	0.0020	0.0024	0.0031	0.0059	0.0079	165 – 230	0.0031	0.0035	0.0047	0.0098	0.0118
	24 – 32 Rc	49 – 82						115 – 148					
	32 – 41 Rc	33 – 49	0.0012	0.0016	0.0024	0.0039	0.0059	82 – 99	0.0020	0.0024	0.0035	0.0055	0.0087
Stainless Steel/Titanium		20 – 33						39 – 53					
Inconel/Nimonic/Waspaloy		16 – 20	0.0008	0.0012	0.0020	0.0028	0.0039	33 – 43	0.0016	0.0020	0.0028	0.0039	0.0059
Brass/Copper		132 – 197						362 – 428					
Copper Alloys Bronze		99 – 132	0.0020	0.0028	0.0035	0.0059	0.0079	263 – 362	0.0028	0.0035	0.0055	0.0106	0.0142
Aluminum		494 – 658	0.0031	0.0039	0.0079	0.0157	0.0197	1,152 – 1,481	0.0047	0.0055	0.0118	0.0217	0.0256
Hardened Aluminum < 6% Si		197 – 329						395 – 592					
Cast Aluminum > 6% Si		132 – 197	0.0024	0.0031	0.0039	0.0059	0.0098	262 – 395	0.0031	0.0039	0.0059	0.0118	0.0157
Thermoplastics		329 – 428	0.0031	0.0035	0.0079	0.0138	0.0157	658 – 855	0.0047	0.0055	0.0118	0.0217	0.0256

Material		Futura/Red'X					Carbide						
		SFM	Feed Inch/Rev					SFM	Feed Inch/Rev				
			2 mm 5/64	3 mm 1/8	6 mm 1/4	10 mm 3/8	16mm 5/8		2 mm 5/64	3 mm 1/8	6 mm 1/4	10 mm 3/8	16mm 5/8
Steel:	< 81 HRB (B)	296 – 395						362 – 461					
	< 24 Rc (C)	247 – 329	0.0039	0.0047	0.0063	0.0118	0.0177	296 – 362	0.0047	0.0055	0.0079	0.0138	0.0217
	24 – 32 Rc	165 – 214						197 – 263					
	32 – 41 Rc	99 – 214	0.0028	0.0031	0.0047	0.0071	0.0110	115 – 165	0.0035	0.0039	0.0055	0.0087	0.0094
Stainless Steel/Titanium		59 – 79						72 – 99					
Inconel/Nimonic/Waspaloy		49 – 66	0.0020	0.0024	0.0039	0.0055	0.0079	63 – 82	0.0031	0.0028	0.0047	0.0067	0.0094
Brass/Copper		4,218 – 494						494 – 592					
Copper Alloys Bronze		362 – 428	0.0039	0.0047	0.0071	0.0142	0.0197	428 – 949	0.0047	0.0055	0.0087	0.0173	0.0240
Aluminum		1,645 – 2,300	0.0063	0.0071	0.0157	0.0295	0.0354	1,974 – 2,632	0.0039	0.0087	0.0193	0.0354	0.0374
Hardened Aluminum < 6% Si		592 – 823						658 – 987					
Cast Aluminum > 6% Si		395 – 559	0.0039	0.0047	0.0071	0.0142	0.0197	461 – 658	0.0047	0.0055	0.0087	0.0173	0.0240
Thermoplastics		987 – 1316	0.0063	0.0071	0.0157	0.0295	0.0354	1,217 – 1,579	0.0079	0.0087	0.0193	0.0354	0.0374

Short & Long NC Spotting Drills

Angle 90°, 118°, 120°

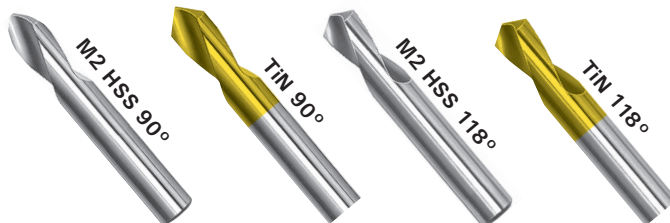
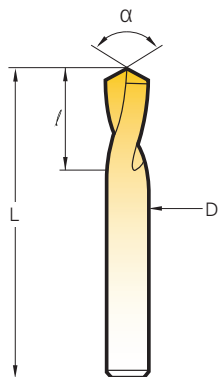
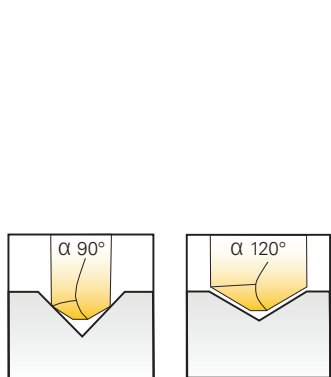

90-degree angle

Centering and chamfering are obtained in a single operation.

118- and 120-degree angle

The preliminary hole obtained corresponds to the angle at the end of the tool used in drilling and prevents it from drifting and allowing the drill point to cut first.

M2 HSS & TiN - Short Series

D (inch)	L (inch)	/	T	Angle 90°		Angle 118°	
				M2 HSS 8119A	TiN 8008A	M2 HSS 8119B	TiN 8008B
1/8	1-1/4	0.0380	0.012	8119A031700	8008A031700	8119B031700	8008B031700
3/16	1-3/8	0.5000	0.020	8119A047600	8008A047600	8119B047600	8008B047600
1/4	1-1/2	0.6400	0.025	8119A063500	8008A063500	8119B063500	8008B063500
5/16			0.031	8119A079300	8008A079300	8119B079300	-
3/8	2	1	0.039	8119A095200	8008A095200	8119B095200	8008B095200
7/16			0.043	8119A111100	8008A111100	8119B111100	8008B111100
1/2			0.051	8119A127000	8008A127000	8119B127000	8008B127000
5/8	2-1/4	1-1/8	0.063	8119A158700	8008A158700	8119B158700	8008B158700
3/4			0.075	8119A190500	8008A190500	8119B190500	8008B190500
7/8	2-1/2	1-1/4	0.088	8119A222200	8008A222200	8119B222200	8008B222200
1			0.100	8119A254000	8008A254000	8119B254000	8008B254000

M2 HSS & TiN - Long Series

3 different lengths

D (inch)	L (inch)	/	T	Angle 90°		Angle 120°	
				M2 HSS 8119C	TiN 8008C	M2 HSS 8119D	TiN 8008D
1/4	2-5/8	0.900	0.025	8119C063500	8008C063500	8119D063500	8008D063500
	4	0.900		8119C063504	8008C063504	8119D063504	8008D063504
	5-1/2	0.87		8119C0635055	8008C0635055	8119D0635055	8008D0635055
3/8	3-1/8	1	0.039	8119C095200	8008C095200	8119D095200	8008D095200
	5			8119C095205	8008C095205	8119D095205	8008D095205
	7			8119C095207	8008C095207	8119D095207	8008D095207
1/2	3-3/4	1-3/8	0.051	8119C127000	8008C127000	8119D127000	8008D127000
	6			8119C127006	8008C127006	8119D127006	8008D127006
	8			8119C127008	8008C127008	8119D127008	8008D127008
5/8	4-1/2	1-3/8	0.063	8119C158700	8008C158700	8119D158700	8008D158700
	8			8119C158708	8008C158708	8119D158708	8008D158708
	9			8119C158709	8008C158709	8119D158709	8008D158709
3/4	5	1-5/8	0.075	8119C190505	8008C190505	8119D190505	8008D190505
	8			8119C190508	8008C190508	8119D190508	8008D190508
	10			8119C190510	8008C190510	8119D190510	8008D190510
1	5-3/8	1-3/4	0.100	8119C254000	8008C254000	8119D254000	8008D254000
	8			8119C254008	8008C254008	8119D254008	8008D254008
	10			8119C254010	8008C254010	8119D254010	8008D254010



Standard Long Extra Long

Tolerances			
Tool Diameters	D (inch)	Angle	L
1/8" - 3/16"	0 - 0.0005	±1°	±0.0395
1/4" - 3/8"	0 - 0.0006		
7/16" - 5/8"	0 - 0.0007		
3/4" - 1"	0 - 0.0008		
1-1/4" - 1-3/4"	0 - 0.0010		



M2 HSS American Standard Spot Drill Value Sets (4 pieces)		
Composition Quantity	Angle 90° 8119C000004	Angle 120° 8119D000004
1 piece each	1/4 x 2-5/8	1/4 x 2-5/8
	3/8 x 3-1/8	3/8 x 3-1/8
	1/2 x 3-3/4	1/2 x 3-3/4
	5/8 x 4-1/2	5/8 x 4-1/2

NC Spotting Drills

Angle 60°, 90°, 120°

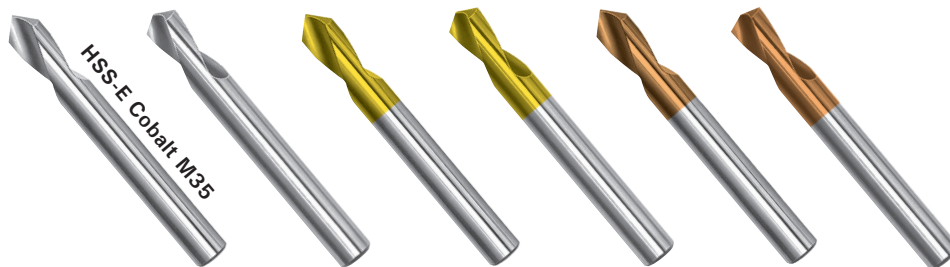
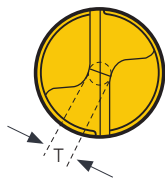

NC Spotting Drills					Angle 60°	Angle 90°	Angle 120°	Angle 90°	Angle 120°	Angle 90°	Angle 120°	
Diameter (inch)	(mm)	L	/	T	Cobalt 191	Cobalt 195	Cobalt 196	M35/TiN 0895	M35/TiN 0896	M35/Red'X 0995*	M35/Red'X 0996*	
0.078	2	2	0.315	0.008	-	81195020000	81196020000	80089502000	80089602000	80099502000	80099602000	
0.118	3		0.400	0.012	-	81195030000	81196030000	80089503000	80089603000	80099503000	80099603000	
1/8			0.400	0.012	-	81195031700	81196031700	80089503170	80089603170	80099503170	80099603170	
0.157	4	2-1/16	0.475	0.016	81191040000	81195040000	81196040000	80089504000	80089604000	80099504000	80099604000	
3/16		2-3/8	0.600	0.020	-	81195047600	81196047600	80089504760	80089604760	80099504760	80099604760	
0.197	5		81191050000	81195050000	81196050000	80089505000	80089605000	80099505000	80099605000			
0.236	6	2-5/8	0.800	0.023	81191060000	81195060000	81196060000	80089506000	80089606000	80099506000	80099606000	
1/4			0.900	0.025	-	81195063500	81196063500	80089506350	80089606350	80099506350	80099606350	
5/16		3-1/8	1	0.031	-	81195079300	-	80089507930	-	-	-	
0.315	8				81191080000	81195080000	81196080000	80089508000	80089608000	80099508000	80099608000	
3/8					-	81195095200	81196095200	80089509520	80089609520	80099509520	80099609520	
0.394	10	3-1/2	1	0.039	81191100000	81195100000	81196100000	80089510000	80089610000	80099510000	80099610000	
0.472	12				81191120000	81195120000	81196120000	80089512000	80089612000	80099512000	80099612000	
1/2		4	1-1/4	0.047	-	81195127000	81196127000	80089512700	80089612700	80099512700	80099612700	
0.551	14		1-3/8	0.055	-	81195140000	81196140000	80089514000	80089614000	80099514000	80099614000	
5/8		4-1/2	1-3/8	0.063	-	81195158700	81196158700	80089515870	80089615870	80099515870	80099615870	
0.630	16				0.063	81191160000	81195160000	81196160000	80089516000	80089616000	80099516000	80099616000
0.709	18	5-1/8	1-5/8	0.071	-	81195180000	81196180000	80089518000	80089618000	80099518000	80099618000	
3/4					0.075	-	81195190500	81196190500	80089519050	80089619050	80099519050	80099619050
0.787	20				0.079	81191200000	81195200000	81196200000	80089520000	80089620000	80099520000	80099620000
0.984	25	5-3/8	1-3/4	0.098	-	81195250000	81196250000	80089525000	80089625000	80099525000	80099625000	
1					0.100	-	81195254000	81196254000	80089525400	80089625400	80099525400	80099625400

*The Spotting Drills (0995 & 0996) with Red'X coating are designed for machining abrasive hard alloys.

NC Spotting Drills - Long								
Diameter (inch)	(mm)	L	/	T	Angle 90° Cobalt 197	Angle 120° Cobalt 199	Angle 90° Carbide 8197	Angle 120° Carbide 8199
0.118	3	3-1/8	0.400	0.012	81197030000	81199030000	88819703000	-
0.157	4	4	0.475	0.016	81197040000	81199040000	88819704000	88819904000
0.197	5	4-3/4	0.600	0.020	81197050000	81199050000	88819705000	88819905000
0.236	6	5-1/2	0.800	0.023	81197060000	81199060000	88819706000	88819906000
1/4			0.870	0.025	81197063500	81199063500	88819706350	88819906350
0.315	8	6-3/4	1	0.031	81197080000	81199080000	88819708000	88819908000
3/8			81197095200	81199095200	88819709520	88819909520		
0.394	10	6-3/4	1	0.039	81197100000	81199100000	88819710000	88819910000
0.472	12				81197120000	81199120000	88819712000	88819912000
1/2		8	1-3/16	0.047	81197120000	81199120000	88819712000	88819912000
5/8			1-3/8	0.051	81197127000	81199127000	88819712700	88819912700
0.630	16	8	1-3/8	0.063	81197158700	81199158700	88819715870	88819915870
3/4			1-3/8		81197160000	81199160000	88819716000	88819916000
0.787	20	1-5/8	0.075	81197190500	81199190500	88819719050	88819919050	
1		1-5/8	0.079	81197200000	81199200000	88819720000	88819920000	
		1-3/4	0.100	81197254000	81199254000	-	-	

Hard'X coatings available with K15 CARBIDE — 6.5 – 7% Cobalt (0,006 – 0,008mm grain size)

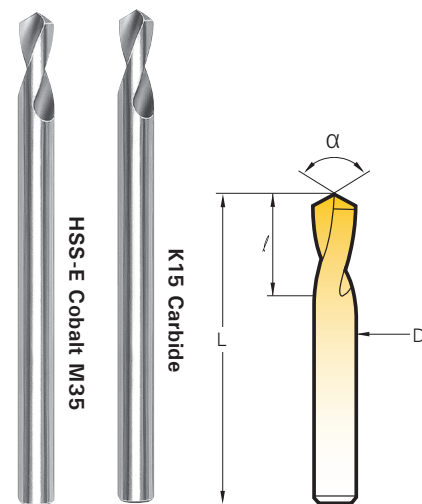

Cobalt Spot Drill Value Sets (4 pieces)		
Composition Quantity	Angle 90° 81195000004	Angle 120° 81196000004
1 piece each	1/4	1/4
	3/8	3/8
	1/2	1/2
	5/8	5/8
	Ø	Ø

Sets also available TiN and Futura coated



NC Spotting Drills

Angle 90°, 120°, 142°

Hard'X
AlTiN Latuma

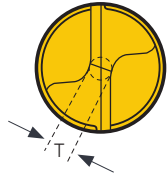

NC Spotting Drills					Angle 90°		Angle 120°		Angle 142°
Diameter (inch)	(mm)	L	f	T*	Carbide 8195	K15/Hard'X 8195-H	Carbide 8196	K15/Hard'X 8196-H	K15/Hard'X 8190-H
0.078	2.0	1-9/16	0.315	0.008	88819502000	888195H0200	88819602000	888196H0200	-
0.118	3.0	1-3/4	0.400	0.012	88819503000	888195H0300	88819603000	888196H0300	-
0.157	4.0	2	0.475	0.016	88819504000	888195H0400	88819604000	888196H0400	-
0.197	5.0	2	0.600	0.020	88819505000	888195H0500	88819605000	888196H0500	-
0.236	6.0		0.700	0.023	88819506000	888195H0600	88819606000	888196H0600	888190H0600
1/4	8.0	2-3/8	0.900	0.023	88819506350	888195H0635	88819606350	888196H0635	888190H0635
5/16					88819507930	888195H0793	-	-	-
0.315	8.0	2-3/8	0.900	0.031	88819508000	888195H0800	88819608000	888196H0800	888190H0800
3/8					88819509520	888195H0952	88819609520	888196H0952	888190H0952
0.394	10.0	2-3/4	0.950	0.039	88819510000	888195H1000	88819610000	888196H1000	888190H1000
0.472					88819512000	888195H1200	88819612000	888196H1200	888190H1200
1/2	14.0	3	0.950	0.051	88819512700	888195H1270	88819612700	888196H1270	888190H1270
0.551					88819514000	888195H1400	88819614000	888196H1400	-
5/8	16.0	3-1/8	1	0.063	88819515870	888195H15870	88819615870	888196H1587	888190H1587
0.630					88819516000	888195H1600	88819616000	888196H1600	888190H1600
0.787	20.0	4	1-3/8	0.079	88819520000	888195H2000	88819620000	888196H2000	-

*T = web thickness of split point

†142° angle : for hard alloys and high performance drilling

K15 CARBIDE — 6.5 – 7% Cobalt (0.006 – 0.008mm grain size)

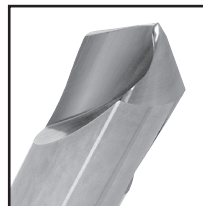
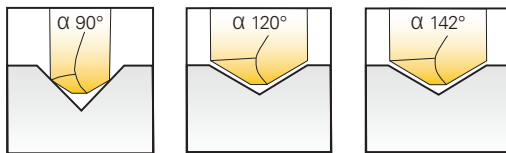
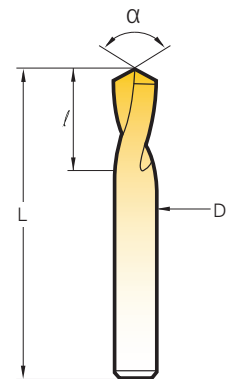

Standard Web Thinning "Split-Point" Feature for High-Speed Cutting

90° NC Spot Drill Centering and chamfering are obtained in a single operation.

120° & 142° NC Spot Drill

The preliminary hole corresponds to the angle at the end of the tool used in drilling and prevents it from deviating



To place an order or to learn more about Pilot Precision Products, contact customer service at 413-350-5200.

DUO-MAG

Double Ended NC Spotting Drills

1 DUO-MAG = 2 Single End NC Spot Drills

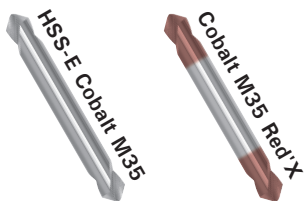

Double End NC Spot Drills - Angle 90°

D	d	L	DUO-MAG 019	Red'X 0919
3/16	1/16	2	80019010000	80091901000
1/4	3/32	2	80019020000	80091902000
3/8	9/64	3	80019030000	80091903000
1/2	3/16	4	80019040000	80091904000

Metric Double End NC Spot Drills - Angle 90°

D x d	L	DUO-MAG 019	Red'X 0919
3.0 x 0.5	40	80019030500	80091903050
4.0 x 1.0	45	80019041000	80091904100
6.0 x 2.0	55	80019062000	80091906200
8.0 x 2.5	65	80019082500	80091908250
10.0 x 3.0	75	80019103000	80091910300
12.0 x 3.5	85	80019123500	80091912350
16.0 x 4.0	90	80019164000	80091916400
20.0 x 5.0	100	80019205000	80091920500

Metric Double End Long NC Spot Drills - Angle 90°

D x d	L	DUO-MAG 019L	Red'X 0919L
3.0 x 0.5	100	80019L03050	800919L0305
4.0 x 1.0	100	80019L04100	800919L0410
6.0 x 2.0	100	80019L06200	800919L0620
8.0 x 2.5	100	80019L08250	800919L0825
10.0 x 3.0	100	80019L10300	800919L1030
12.0 x 3.5	100	80019L12350	800919L1235
16.0 x 4.0	150	80019XL1640	800919XL164
20.0 x 5.0	150	80019XL2050	800919XL205

Tolerances

Tool Diameters	D (inch)	Angle	L
0.078 - 0.118	0 + 0.0002"	±1°	±0.0395
1/8 - 0.236	0 + 0.0003"		
1/4 - 0.394	0 + 0.0004"		
0.472 - 1	0 + 0.0005"		

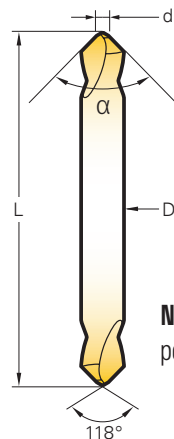

Note: The 118° sharpening angle makes tool penetration easier, while reinforcing the point. (d)



Duo Mag Sets American Standard

Composition Quantity	4 Pieces Cobalt 8001900004	4 Pieces Red'X 80091900004
1 piece each	3/16"	3/16"
	1/4"	1/4"
	3/8"	3/8"
	1/2"	1/2"

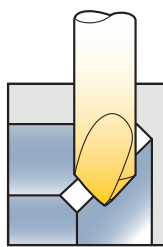

Longitudinal Chamfering

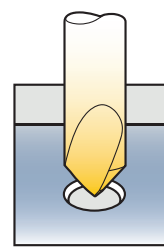

Chamfering

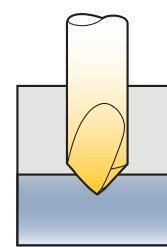

Centering Spotting

1 Multi-V = 10 Operations

MULTI-V®

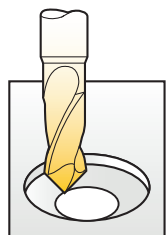

90°-120°
Interpolation Milling

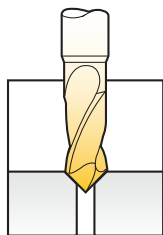

90°-120°
Chamfering

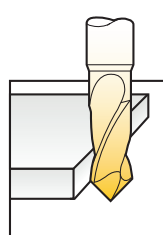

60°-90°-120°
Contouring Side Milling

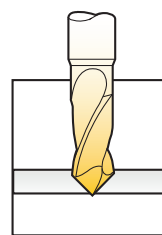

60°-90°-120°
Direct Chamfering

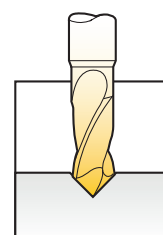

90°-120°
Centering - Spotting

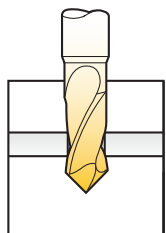

90°-120°
Drilling

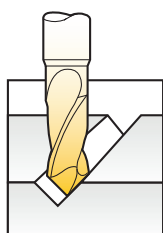

90°-120°
V - Grooving

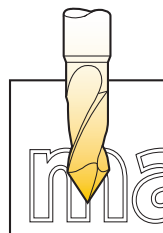

40°-60°-90°
Engraving

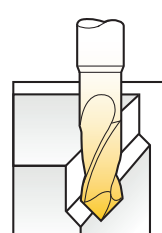

60°-90°-120°
Longitudinal Chamfers

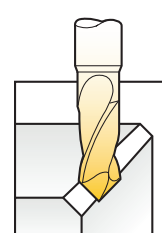

This is the ideal tool for machine centers and NC processing machines.

- The Multi-V combines multiple machining process to:
 - reduce machine set-up time
 - reduce operating time
 - reduce overall tool changes.
- Easy storage:
 - fewer tools required.
 - less tool spaces required in magazine
- Improved performances:
 - fine cutting edge with improved depth and surface finish
 - micro grain solid carbide for better wear resistance and greater rigidity
 - 30° spiral helix facilitates better chip removal

Metric Multi-V - Angles 40°, 60°
K15 Carbide — 6.5 – 7% Cobalt (0.006 – 0.008mm grain size)

Diameter		L	/	d2	T*	Angle 40°		Angle 60°	
(inch)	(mm)					Multi-V 8040†	Multi-V 8088†	Hard'X 8088-H†	
0.020	0.5	1-1/2	0.040	0.118	0.002	88804000500	88808800500	888088H0050	
0.031	0.8	1-1/2	0.063	0.118	0.003	-	88808800800	888088H0080	
0.039	1.0	1-1/2	0.080	0.118	0.004	88804001000	88808801000	888088H0100	
0.047	1.2	1-1/2	0.095	0.118	0.005	-	88808801200	888088H0120	
0.059	1.5	1-1/2	0.120	0.118	0.006	88804001500	88808801500	888088H0150	
0.070	1.8	1-1/2	0.142	0.118	0.007	-	88808801800	888088H0180	
0.078	2.0	1-1/2	0.160	0.118	0.008	88804002000	88808802000	888088H0200	
0.098	2.5	1-1/2	0.195	0.118	0.010	-	88808802500	888088H0250	
0.118	3	2	0.240	0.157	0.012	88804003000	88808803000	888088H0300	
0.157	4	2	0.315	0.197	0.016	-	88808804000	888088H0400	
0.197	5	2	0.395	0.236	0.020	88804005000	88808805000	888088H0500	
0.236	6	2-3/8	0.475	0.315	0.023	-	88808806000	888088H0600	
0.315	8	2-3/4	0.630	0.394	0.031	-	88808808000	888088H0800	
0.394	10	2-3/4	0.710	0.472	0.039	-	88808810000	888088H1000	
0.472	12	2-3/4	0.790	0.472	0.047	-	88808812000	888088H1200	
0.630	16	3-1/8	1.025	0.630	0.063	-	88808816000	888088H1600	
0.787	20	4	1.260	0.787	0.079	-	88808820000	888088H2000	



K15 Carbide

*T = web thickness of split point
† Angle 40° – 60° : ideal for engraving

1 Multi-V = 10 Operations

Hard'X
AITIN Latuma

Standard Multi-V - Angle 90°
K15 Carbide — 6.5 – 7% Cobalt (0.006 – 0.008mm grain size)

Diameter		L	/	d2	T	Multi-V 8090	Hard'X 8090-H
(inch)	(mm)						
0.003	0.1	1-1/2	0.008	0.118	0.001	88809000100	888090H0010
0.007	0.2	1-1/2	0.016	0.118	0.001	88809000200	888090H0020
0.011	0.3	1-1/2	0.024	0.118	0.001	88809000300	888090H0030
0.015	0.4	1-1/2	0.032	0.118	0.002	88809000400	888090H0040
0.020	0.5	1-1/2	0.040	0.118	0.002	88809000500	888090H0050
0.024	0.6	1-1/2	0.047	0.118	0.002	88809000600	888090H0060
0.028	0.7	1-1/2	0.055	0.118	0.003	88809000700	888090H0070
0.031	0.8	1-1/2	0.063	0.118	0.003	88809000800	888090H0080
0.035	0.9	1-1/2	0.071	0.118	0.003	88809000900	888090H0090
0.039	1.0	1-1/2	0.080	0.118	0.004	88809001000	888090H0100
0.043	1.1	1-1/2	0.087	0.118	0.004	88809001100	888090H0110
0.047	1.2	1-1/2	0.095	0.118	0.005	88809001200	888090H0120
0.051	1.3	1-1/2	0.102	0.118	0.005	88809001300	888090H0130
0.055	1.4	1-1/2	0.110	0.118	0.006	88809001400	888090H0140
0.059	1.5	1-1/2	0.120	0.118	0.006	88809001500	888090H0150
0.0625	1.58	1-3/4	0.126	0.125	0.007	88809015870	888090H1587
0.063	1.6	1-1/2	0.125	0.118	0.006	88809001600	888090H0160
0.066	1.7	1-1/2	0.134	0.118	0.007	88809001700	888090H0170
0.071	1.8	1-1/2	0.140	0.118	0.007	88809001800	888090H0180
0.074	1.9	1-1/2	0.145	0.118	0.008	88809001900	888090H0190
0.078	2.0	1-1/2	0.160	0.118	0.008	88809002000	888090H0200
0.082	2.1	1-1/2	0.165	0.118	0.008	88809002100	888090H0210
0.086	2.2	1-1/2	0.173	0.118	0.009	88809002200	888090H0220
0.090	2.3	1-1/2	0.181	0.118	0.009	88809002300	888090H0230
0.094	2.4	1-1/2	0.190	0.118	0.009	88809002400	888090H0240
0.098	2.5	1-1/2	0.195	0.118	0.010	88809002500	888090H0250
0.102	2.6	1-1/2	0.205	0.118	0.010	88809002600	888090H0260
0.118	3.0	2	0.240	0.157	0.012	88809003000	888090H0300
0.125	3.17	2	0.248	0.188	0.013	88809003170	888090H0317
0.157	4.0	2	0.315	0.197	0.016	88809004000	888090H0400
3/16	-	2	0.375	1/4	0.020	88809004760	888090H0476
0.197	5.0	2	0.395	0.236	0.020	88809005000	888090H0500
0.236	6.0	2-3/4	0.475	0.315	0.023	88809006000	888090H0600
1/4	-	2-3/4	0.475	5/16	0.025	88809006350	888090H0635
5/16	-	2-3/4	0.630	3/8	0.031	88809007930	888090H0793
0.315	8.0	2-3/4	0.630	0.394	0.031	88809008000	888090H0800
3/8	-	2-3/4	0.710	1/2	0.039	88809009520	888090H0952
0.394	10.0	2-3/4	0.710	0.472	0.039	88809010000	888090H1000
0.472	12.0	2-3/4	0.790	0.47	0.047	88809012000	888090H1200
1/2	-	2-3/4	0.790	1/2	0.051	88809012700	888090H1270
5/8	-	3-1/8	1.000	5/8	0.063	88809015870	888090H1587
0.630	16.0	3-1/8	1.025	0.630	0.063	88809016000	888090H1600
0.787	20.0	4	1.260	0.787	0.079	88809020000	888090H2000

*T = web thickness of split point

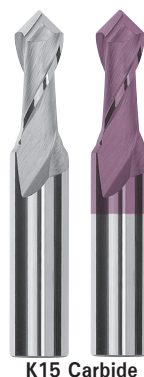

K15 Carbide

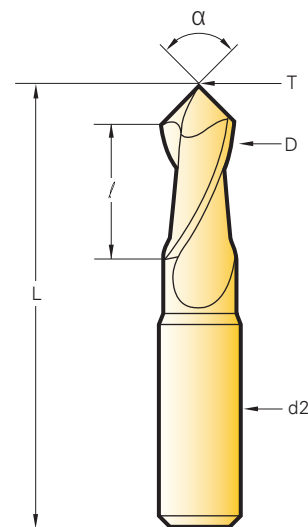

Tolerances

L	D	α	d2
0.003 – 0.118	-0 – 0.0010		
0.157 – 0.236	-0 – 0.0012	± 1°	0.157 – 0.197 1 – 0.00030
0.250 – 0.394	-0 – 0.0014	0.197 – 0.500	1 – 0.00035
0.472 – 0.630	-0.0018 – 0.0036	0.500 – 0.630	1 – 0.00045
0.787	-0.0025 – 0.0045	0.787	1 – 0.00050

Metric Multi-V - Angle 100°, 120°
K15 Carbide — 6.5 – 7% Cobalt (0.006 – 0.008mm grain size)

Diameter		L	/	d2	T	Angle 120°		Angle 100°	
(inch)	(mm)					Multi-V 8092	Hard'X 8092-H	Multi-V 8095	Hard'X 8095-H
0.039	1.0	1-1/2	0.080	0.118	0.004	88809201000	888092H0100	-	-
0.059	1.5	1-1/2	0.120	0.118	0.006	88809201500	888092H0150	-	-
0.078	2.0	1-1/2	0.160	0.118	0.008	88809202000	888092H0200	-	-
0.098	2.5	1-1/2	0.195	0.118	0.010	88809202500	888092H0250	-	-
0.118	3.0	2	0.240	0.157	0.012	88809203000	888092H0300	-	-
0.157	4.0	2	0.315	0.197	0.016	88809204000	888092H0400	-	-
0.197	5.0	2	0.395	0.236	0.020	88809205000	888092H0500	-	-
0.236	6.0	2-3/8	0.475	0.315	0.023	88809206000	888092H0600	88809506000	888095H0600
0.315	8.0	2-3/4	0.630	0.394	0.031	88809208000	888092H0800	88809508000	888095H0800
0.394	10.0	2-3/4	0.710	0.472	0.039	88809210000	888092H1000	88809510000	888095H1000
0.472	12.0	2-3/4	0.790	0.472	0.047	88809212000	888092H1200	88809512000	888095H1200
0.630	16.0	2-1/8	1.025	0.630	0.063	88809216000	888092H1600	88809516000	888095H1600
0.787	20.0	4	1.260	0.787	0.079	88809220000	888092H2000	-	-

*T = web thickness of split point



K15 Carbide

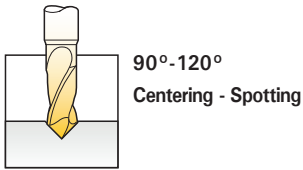

**90°-120°
Centering - Spotting**

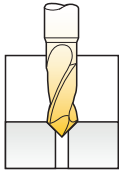

**90°-120°
Chamfering**

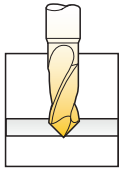

**60°-90°-120°
Direct Chamfering**

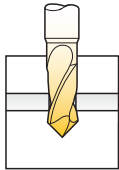

**90°-120°
Drilling**

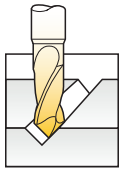

**90°-120°
V - Grooving**

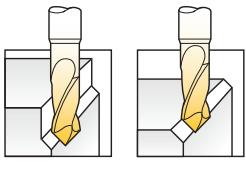

**60°-90°-120°
Longitudinal Chamfers**

Longitudinal Chamfers



**40°-60°
Engraving**

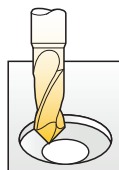

**90°-120°
Interpolation
Milling**

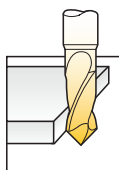

**60°-90°-120°
Contouring
Side Milling**

Performance Recommendations for Use								
Material	SFM	RPM IPM inch/tooth	Diameter			Feed inches/rev.		
			3mm - 3/16"	5mm - 1/4"	10mm - 5/16"	12mm - 1/2"	16mm - 5/8"	20mm
Steel < 81 HRB (B)	230 - 247	RPM IPM inch/tooth	6400 12.6 0.002	4000 12.6 0.0031	2500 13.8 0.0055	1900 14.2 0.0075	1500 14.2 0.0094	1300 14.3 0.0110
Steel < 24 Rc (C)	132 - 197	RPM IPM inch/tooth	4000 7.9 0.002	2600 8.2 0.0031	1600 8.8 0.0055	1200 9.4 0.0075	900 8.9 0.0094	850 9.4 0.0110
Steels 24 - 32 RC Cast Iron < 180 HB (Grey Cast Iron)	115 - 132	RPM IPM inch/tooth	3200 5.7 0.0018	2200 6.1 0.0028	1400 6.6 0.0047	1000 7.1 0.0071	850 7.4 0.0087	680 7.5 0.0110
Steels 32 - 41 RC Cst Iron > 180 HB Stainless Steels	99 - 115	RPM IPM inch/tooth	2800 5.0 0.0018	1800 5.0 0.0028	1100 5.2 0.0047	800 5.4 0.0067	650 5.6 0.0087	550 5.6 0.0102
Titanium Alloys	82 - 99	RPM IPM inch/tooth	2200 3.5 0.0016	1600 3.8 0.0024	900 3.9 0.0043	660 4.1 0.0063	500 4.3 0.0087	480 4.7 0.0098
Ni Co Alloys Inconel - Nimonic - Waspaloy	66	RPM IPM inch/tooth	1800 2.8 0.0016	1100 2.6 0.0024	700 3.0 0.0043	500 3.1 0.0063	400 3.1 0.0079	320 3.1 0.0098
Copper Alloys Bronze	165 - 395	RPM IPM inch/tooth	5000 19.7 0.0039	3500 20.7 0.0059	2200 21.7 0.0098	1900 22.4 0.0118	1700 23.4 0.0138	1400 24.8 0.0177
Aluminum	494	RPM IPM inch/tooth	10000 19.7 0.0020	6300 22.3 0.0035	4000 23.6 0.0059	3200 25.2 0.0079	2500 26.6 0.0106	2000 27.6 0.0138
Thermoplastics	494	RPM IPM inch/tooth	7300 14.4 0.002	4600 16.3 0.0035	2800 20.9 0.0075	2900 22.8 0.0079	2300 24.4 0.0106	1900 26.2 0.0138

Material	SFM	RPM IPM inch/tooth	Diameter			Feed inches/rev.		
			3mm - 3/16"	5mm - 1/4"	10mm - 5/16"	12mm - 1/2"	16mm - 5/8"	20mm
Steel < 81 HRB (B)	230 - 247	RPM IPM inch/tooth	6800 2.6 0.0002	4300 2.6 0.0003	2650 2.8 0.0006	2000 3.0 0.0007	1500 3.0 0.0010	1200 3.0 0.0012
Steel < 24 Rc (C)	132 - 197	RPM IPM inch/tooth	5400 2.2 0.0002	3500 2.2 0.0003	2100 2.3 0.0006	1600 2.4 0.0007	1200 2.4 0.0010	1000 2.4 0.0012
Steels 24 - 32 RC Cast Iron < 180 HB (Grey Cast Iron)	115 - 132	RPM IPM inch/tooth	3600 1.1 0.0002	2300 1.1 0.0002	1400 1.3 0.0005	1000 1.4 0.0007	800 1.4 0.0008	630 1.4 0.0011
Steels 32 - 41 RC Cst Iron > 180 HB Stainless Steels	99 - 115	RPM IPM inch/tooth	3000 1.0 0.0002	2000 1.0 0.0002	1200 1.2 0.0005	900 1.2 0.0006	700 1.2 0.0008	550 1.2 0.0011
Titanium Alloys	82 - 99	RPM IPM inch/tooth	2200 0.7 0.0002	1600 0.8 0.0002	1000 0.8 0.0004	760 0.8 0.0005	600 0.9 0.0007	400 0.9 0.0011
Ni Co Alloys Inconel - Nimonic - Waspaloy	66	RPM IPM inch/tooth	1800 0.4 0.0001	1100 0.5 0.0002	700 0.6 0.0004	500 0.6 0.0005	400 0.6 0.0007	320 0.6 0.0010
Copper Alloys Bronze	165 - 395	RPM IPM inch/tooth	7000 4.4 0.0003	6000 4.7 0.0004	3500 4.7 0.0007	3200 5.0 0.0008	2200 5.2 0.0012	1750 5.5 0.0016
Aluminum	494	RPM IPM inch/tooth	13000 7.9 0.0003	8600 8.7 0.0005	5300 9.4 0.0009	4000 9.4 0.0012	3000 9.8 0.0017	2400 9.8 0.0020
Thermoplastics	494	RPM IPM inch/tooth	13000 10.2 0.0004	8600 10.2 0.0006	5300 10.4 0.0010	4000 10.6 0.0013	3000 10.6 0.0018	2400 10.6 0.0022

Material	SFM	RPM IPM inch/tooth	Diameter			Feed inches/rev.		
			3mm - 3/16"	5mm - 1/4"	10mm - 5/16"	12mm - 1/2"	16mm - 5/8"	20mm
Steel < 81 HRB (B)	230 - 247	RPM IPM inch/tooth	6800 4.3 0.003	4300 4.7 0.0006	2650 5.1 0.0010	2000 5.9 0.0016	1500 6.1 0.0020	1200 6.1 0.0026
Steel < 24 Rc (C)	132 - 197	RPM IPM inch/tooth	5400 3.3 0.0003	3500 3.5 0.0005	2100 4.1 0.0010	1600 4.7 0.0016	1200 4.9 0.0020	1000 4.9 0.0024
Steels 24 - 32 RC Cast Iron < 180 HB (Grey Cast Iron)	115 - 132	RPM IPM inch/tooth	3600 2.3 0.0003	2300 2.4 0.0005	1400 2.8 0.0010	1000 3.1 0.0016	800 3.1 0.0020	630 3.1 0.0024
Steels 32 - 41 RC Cst Iron > 180 HB Stainless Steels	99 - 115	RPM IPM inch/tooth	3000 1.8 0.0003	2000 2.0 0.0005	1200 2.4 0.0010	900 2.6 0.0014	700 2.6 0.0020	550 2.6 0.0024
Titanium Alloys	82 - 99	RPM IPM inch/tooth	2200 1.4 0.0003	1600 1.6 0.0005	1000 2.0 0.0010	760 2.2 0.0014	600 2.2 0.0018	400 2.2 0.0028
Ni Co Alloys Inconel - Nimonic - Waspaloy	66	RPM IPM inch/tooth	1800 1.0 0.0003	1100 1.0 0.0004	700 1.4 0.0010	500 1.4 0.0014	400 1.6 0.0020	320 1.6 0.0024
Copper Alloys Bronze	165 - 395	RPM IPM inch/tooth	10000 7.9 0.0004	7000 8.3 0.0006	3600 8.5 0.0012	2500 8.9 0.0018	1800 9.1 0.0020	1400 9.2 0.0026
Aluminum	494	RPM IPM inch/tooth	13000 8.3 0.0003	8600 8.9 0.0005	5300 12.6 0.0012	4000 14.2 0.0018	3000 11.8 0.0020	2400 12.2 0.0026
Thermoplastics	494	RPM IPM inch/tooth	13000 12.2 0.0005	8600 10.2 0.0006	5300 14.6 0.0014	4000 15.7 0.0020	3000 12.6 0.0020	2400 13.0 0.0028

Applications: **Front and Back Chamfering**

Hard'X
AlTiN Latuma

Bi-Face Advantages

Special design = positive cut + relieving profile

- Unequalled surface finish
- Impressive performance
- Extended tool profile life

*For super finish operations, **Bi-face** has a constant relieved profile. Longitudinal or interpolated work for front and back chamfering of edges and holes.*

Tolerances			
D	Tolerance	L	α
$\varnothing .040 \sim 0.197$	0 - 0.002	± 0.040	$\pm 1^\circ$
$\varnothing .236 \sim 0.630$	0 - 0.004	± 0.040	$\pm 1^\circ$



K15 Carbide

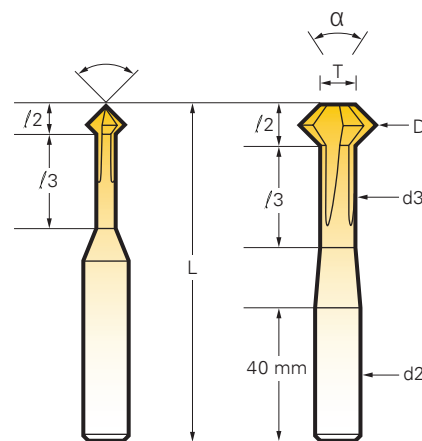

Mini

Standard

Mini - Angle 90° 3 Flutes									
Diameter (inch) (mm)		d2	d3 max	T max	L min	l/2	l/3	Bi-face 8480	Hard'X 8480-H
0.040	1.0	0.118	0.028	0.012	2-3/8	0.020	0.197	88848001000	888480H0100
0.059	1.5		0.043	0.018		0.029	0.236	88848001500	888480H0150
0.079	2.0		0.059	0.024		0.037	0.315	88848002000	888480H0200
0.118	3.0		0.087	0.035		0.059	0.394	88848003000	888480H0300

Standard - Angle 90° 4 Flutes									
Diameter (inch) (mm)		d2	d3 max	T max	L min	l/2	l/3	Bi-face 8490	Hard'X 8490-H
0.118	3.0	0.236	0.087	0.047	4	0.051	0.394	88849003000	888490H0300
0.157	4.0		0.114	0.063		0.069	0.472	88849004000	888490H0400
0.197	5.0		0.134	0.079		0.091	0.591	88849005000	888490H0500
0.236	6.0		0.154	0.094		0.114	0.709	88849006000	888490H0600
0.315	8.0		0.193	0.193	0.118	1.339	88849008000	888490H0800	
0.394	10.0		0.232	0.232	0.157		88849010000	888490H1000	
0.472	12.0		0.232	0.232	0.236		88849012000	888490H1200	
0.630	16.0		0.394	0.311	0.311		0.315	88849016000	888490H1600

Standard - Angle 60° 4 Flutes									
Diameter (inch) mm		d2	d3 max	T max	L min	l/2	l/3	Bi-face 8460	Hard'X 8460-H
0.197	5.0	0.236	0.134	0.134	4	0.110	/	88846005000	888460H0500
0.315	8.0	0.236	0.193	0.232		0.213	1.339	88846008000	888460H0800
0.472	12.0	0.394	0.232	0.232		0.413	/	88846012000	888460H1200

See contouring section on page 85 for Bi-Face performance parameters.

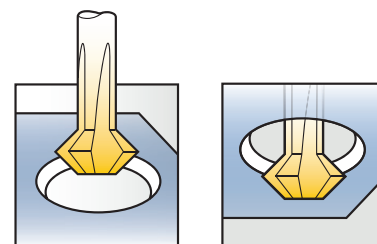

Front Chamfering

Back Chamfering

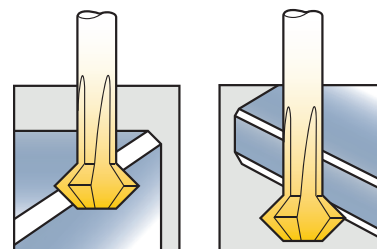

Top Chamfering

Bottom Chamfering

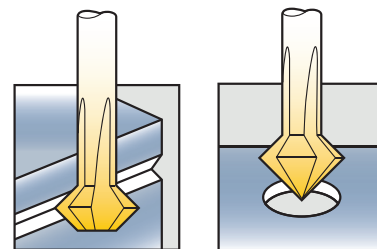

V-Grooving

Deburring

Angle 60°

Thread Milling Cutters - Angle 60° 3 Flutes						
Screw Diameter	D (mm)	d2	d1	L	/	Hard'X 845-H
M0.8	0.57	3	0.27	39	2.4	88845MH0080
M0.9	0.64		0.31		2.7	88845MH0090
M1.0	0.71		0.35		3.0	88845MH0100
M1.2	0.91		0.55		3.6	88845MH0120
M1.4	1.06		0.62		4.2	88845MH0140
M1.6	1.2		0.69		4.8	88845MH0160
M1.8	1.35		0.84		5.5	88845MH0180
M2.0	1.5		0.92		6	88845MH0200
M2.5	1.9		1.27		7	88845MH0250
M3	2.3		1.57		9	88845MH0300
M4	3.1	6	2.09	66	12	88845MH0400
M5	4.0		2.90		15	88845MH0500
M6	4.8		3.47		18	88845MH0600
M8	6.5	8	4.85	80	22	88845MH0800
M10	7.9		5.95		26	88845MH1000



K15 Carbide

The same tool will achieve different pitches (right or left hand), in blind or thru holes.

Multi-Function Carbide Miniature Tools

Applications: **Corner Rounding End-Mills**



K15 Carbide

These cutters are designed for CNC machines and allow machining of even very thin materials and easy regrinds.



The radius is positioned in relation to the small Ø d1-, making it possible to machine compound forms, small slots and holes from 0.5mm.

Hard'X
AlTiN Latuma

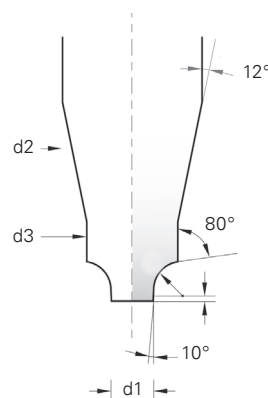

Miniature									
Radius		d1	d2	d3	Δx	/	L	Carbide 8550	Hard'X 8550-H
(inch)	(mm)								
0.0039	0.10	0.020	0.118	0.031	0.35	0.098	2	88855000100	888550H0010
0.0059	0.15							88855000150	888550H0015
0.0079	0.20							88855000200	888550H0020
0.0098	0.25							88855000250	888550H0025
0.0118	0.30							88855000300	888550H0030
0.0157	0.40							88855000400	888550H0040
0.0197	0.50							88855000500	888550H0050
0.0236	0.60							88855000600	888550H0060
0.0276	0.70							88855000700	888550H0070
0.0295	0.75							88855000750	888550H0075
0.0315	0.80	0.031	0.157	0.134	1.65	0.157	2	88855000800	888550H0080
0.0354	0.90							88855000900	888550H0090
0.0394	1.00							88855001000	888550H0100
0.0492	1.25							88855001250	888550H0125
0.0591	1.50							88855001500	888550H0150
0.0689	1.75							88855001750	888550H0175
0.0787	2.00							88855002000	888550H0200
0.0886	2.25							88855002250	888550H0225
0.0984	2.50							88855002500	888550H0250
0.1181	3.00							88855003000	888550H0300
0.1575	4.00	0.075	0.394	0.394	4.95	-	2-3/16	88855004000	888550H0400
0.1969	5.00	0.075	0.472	0.472	5.95	-	2-1/2	88855005000	888550H0500

Coating is available

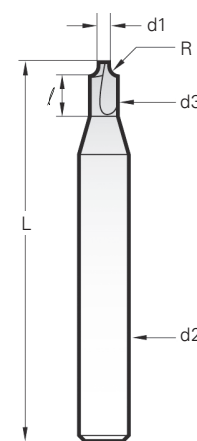

Tolerances			
R	d1	d2	L
± .0008	± .00039	h6	± .0040

TRI-DENT Imperial

3 Flute Countersinks

Three Flute Countersinks								
Angle	Diameter		Capacity min/max	d	L	Cobalt	Angle	M35/TiN
	(inch)	(mm)						
30° 439	0.248	6.30	0.079 – 0.248	0.197	2	84439063000	30° 4839	84483906300
	0.488	12.40	0.012 – 0.488	0.315	2-1/2	84439124000		84483912400
	0.650	16.50	0.157 – 0.650	0.394	3	84439165000		84483916500
	0.984	25.00	0.236 – 0.984	0.394	3-1/2	84439250000		84483925000
60° 432	0.248	6.30	0.051 – 0.248	0.197	1-7/8	84432063000	60° 4832	84483206300
	0.327	8.30	0.071 – 0.327	0.236	2	84432083000		84483208300
	0.410	10.40	0.091 – 0.410	0.236	2	84432104000		84483210400
	0.488	12.40	0.098 – 0.488	0.315	2-3/8	84432124000		84483212400
	0.650	16.50	0.110 – 0.650	0.394	2-1/2	84432165000		84483216500
	0.807	20.50	0.118 – 0.807	0.940	2-3/4	84432205000		84483220500
	0.984	25.00	0.126 – 0.984	0.394	3	84432250000		84483225000
	1.220	31.00	0.138 – 1.22	0.472	3-1/8	84432310000		84483231000
82° 434	0.248	6.30	0.051 – 0.248	0.197	1-3/4	84434063000	82° 4834	84483406300
	1/4	6.35	0.051 – 0.250	1/4	1-3/4	84434063500		84483406350
	5/16	7.94	0.070 – 0.312	1/4	1-3/4	84434079300		84483407930
	0.327	8.30	0.070 – 0.327	0.236	2	84434083000		84483408300
	3/8	9.52	0.085 – 0.375	1/4	2	84434095200		84483409520
	0.410	10.40	0.087 – 0.410	0.236	2	84434104000		84483410400
	0.488	12.40	0.098 – 0.488	0.315	2-1/4	84434124000		84483412400
	1/2	12.70	0.100 – 0.500	1/4	2	84434127000		84483412700
	5/8	15.87	0.110 – 0.625	3/8	2-3/8	84434158700		84483415870
	0.650	16.50	0.110 – 0.650	0.394	2-3/8	84434165000		84483416500
	3/4	19.05	0.120 – 0.750	3/8	2-3/8	84434190500		84483419050
	0.807	20.50	0.118 – 0.807	0.394	2-1/2	84434205000		84483420500
	0.984	25.00	0.126 – 0.984	0.394	2-11/16	84434250000		84483425000
	1.000	25.40	0.125 – 1.000	3/8	2-3/4	84434254000		84483425400
	1.220	31.00	0.138 – 1.220	0.472	2-7/8	84434310000		84483431000
	90°	0.158	4.00	0.051 – 0.158	0.158	1-5/8		84431040000
0.170		4.30	0.051 – 0.170	0.158	1-5/8	84431043000	84483104300	
0.197		5.00	0.051 – 0.197	0.158	1-5/8	84431050000	84483105000	
0.209		5.30	0.051 – 0.209	0.197	1-3/4	84431053000	84483105300	
0.229		5.80	0.051 – 0.229	0.197	1-3/4	84431058000	84483105800	
0.236		6.00	0.051 – 0.236	0.197	1-3/4	84431060000	84483106000	
0.248		6.30	0.051 – 0.248	0.197	1-3/4	84431063000	84483106300	
1/4		6.35	0.050 – 0.250	1/4	1-3/4	84431063500	84483106350	
0.276		7.00	0.063 – 0.279	0.236	2	84431070000	84483107000	
0.288		7.30	0.063 – 0.288	0.236	2	84431073000	84483107300	
5/16		7.94	0.070 – 0.312	1/4	1-3/4	84431079300	84483107930	
0.315		8.00	0.017 – 0.315	0.236	2	84431080000	84483108000	
0.327		8.30	0.071 – 0.327	0.236	2	84431083000	84483108300	
0.354		9.00	0.079 – 0.354	0.236	2	84431090000	84483109000	
0.370		9.40	0.079 – 0.370	0.236	2	84431094000	84483109400	
3/8		9.52	0.085 – 0.375	1/4	3	84431095200	84483109520	
0.394		10.00	0.087 – 0.394	0.236	4	84431100000	84483110000	
0.410		10.40	0.087 – 0.410	0.236	5	84431104000	84483110400	
0.453		11.50	0.098 – 0.453	0.315	2-1/4	84431115000	84483111500	
0.472		12.00	0.098 – 0.472	0.315	2-1/4	84431120000	84483112000	
0.488		12.40	0.098 – 0.488	0.315	2-1/4	84431124000	84483112400	
1/2		12.70	0.100 – 0.500	1/4	2	84431127000	84483112700	
0.528		13.40	0.098 – 0.528	0.315	2-1/4	84431134000	84483113400	
0.567		14.40	0.098 – 0.567	0.315	2-1/4	84431144000	84483114400	
0.590		15.00	0.110 – 0.590	0.394	2-3/8	84431150000	84483115000	
5/8		15.87	0.110 – 0.625	3/8	2-3/8	84431158700	84483115870	
0.650		16.50	0.110 – 0.650	0.394	2-3/8	84431165000	84483116500	
0.748		19.00	0.118 – 0.748	0.394	2-1/2	84431190000	84483119000	
3/4		19.05	0.120 – 0.750	3/8	2-3/8	84431190500	84483119050	
0.807		20.50	0.118 – 0.807	0.394	2-1/2	84431205000	84483120500	
0.906		23.00	0.126 – 0.906	0.394	2-5/8	84431230000	84483123000	
0.984		25.00	0.126 – 0.984	0.394	2-5/8	84431250000	84483125000	
1.000	25.40	0.125 – 1.00	3/8	2-3/4	84431254000	84483125400		
1.024	26.00	0.126 – 1.024	0.394	2-5/8	84431260000	84483126000		
1.102	28.00	0.138 – 1.102	0.472	2-3/4	84431280000	84483128000		
1.181	30.00	0.138 – 1.181	0.472	2-3/4	84431300000	84483130000		
1.220	31.00	0.138 – 1.220	0.472	2-3/4	84431310000	84483131000		

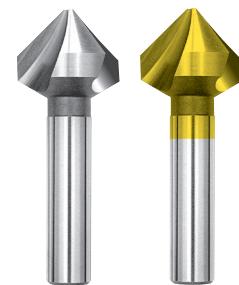

HSS-E Cobalt M35

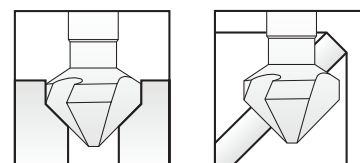

Countersink

Chamfer

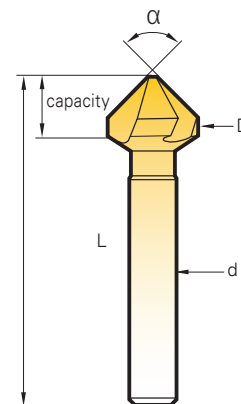

TRI-DENT Imperial

3 Flute Countersinks & Sets

Three Flute Countersinks								
Angle	Diameter		Capacity min/max	d	L	Cobalt	Angle	M35/TiN
	(inch)	(mm)						
100° 435	0.248	6.30	0.051 – 0.248	0.197	1-3/4	84435063000	100° 4835	84483506300
	0.327	8.30	0.070 – 0.327	0.236	2	84435083000		84483508300
	0.410	10.40	0.087 – 0.410	0.236	2	84435104000		84483510400
	0.488	12.40	0.098 – 0.488	0.315	2-3/16	84435124000		84483512400
	0.650	16.50	0.110 – 0.650	0.394	2-5/16	84435165000		84483516500
	0.807	20.50	0.118 – 0.807	0.394	2-7/16	84435205000		84483520500
	0.984	25.00	0.126 – 0.984	0.394	2-1/2	84435250000		84483525000
	1.220	31.00	0.138 – 1.220	0.472	2-11/16	84435310000		84483531000
120° 433	0.248	6.30	0.051 – 0.248	0.197	1-3/4	84433063000	120° 4833	84483306300
	0.327	8.30	0.070 – 0.327	0.236	2	84433083000		84483308300
	0.410	10.40	0.087 – 0.410	0.236	2	84433104000		84483310400
	0.488	12.40	0.098 – 0.488	0.315	2-1/8	84433124000		84483312400
	0.650	16.50	0.110 – 0.650	0.394	2-1/4	84433165000		84483316500
	0.807	20.50	0.118 – 0.807	0.394	2-5/16	84433205000		84483320500
	0.984	25.00	0.126 – 0.984	0.394	2-1/2	84433250000		84483325000
	1.220	31.00	0.138 – 1.220	0.472	2-1/2	84433310000		84483331000



84431000000-M

84431000000 / 84436000000

3 Flute Countersink Sets		
Angle	Cobalt	Composition (mm)
60°	84432000000	10.4 16.5
	84483200000 TiN	
82°	84434000000	20.5
	84483400000 TiN	
100°	84435000000	25
120°	84433000000	31

Trident Countersink Sets		
Angle	EDP No.	Composition (mm)
60°	84432000000	Ø 10.4 - 16.5 20.5 - 25 - 31
	84483200000 TiN	
82°	84434000000	
	84483400000 TiN	
100°	84435000000	
120°	84433000000	

Countersink Sets - Angle 90°	
EDP No.	Composition
84431000000	10.4 - 16.5 - 20.5 - 25.0 - 31.0mm
84483100000 TiN	
84436000000	
84431000002	6.3 - 8.3 - 10.4 - 12.4 - 16.5 - 20.5mm
84483100002 TiN	
84436000002	
88843100002	

TRI-DENT Metric | 60° and 82° Three Flute Countersinks

Applications: Countersinking and Chamfering



Three Flute Countersinks - Angle 60° DIN 334-C				
D (mm)	d1 max	d2	L	Magaforce 8432
6.3	1.5	5	47	88843206300
8.3	2.0	6	52	88843208300
10.4	2.5	6	53	88843210400
12.4	2.8	8*	60	88843212400
16.5	3.2	10*	65	88843216500
20.5	3.5	10*	69	88843220500
25.0	3.8	10*	75	88843225000
31.0	4.2	12*	81	88843231000

*3 flattened shanks = effective holding

Three Flute Countersinks - Angle 82° DIN 334-C				
D (mm)	d1 max	d2	L	Magaforce 8434
10.4	2.5	6	50	88843410400
12.4	2.8	8*	56	88843412400
16.5	3.2	10*	61	88843416500
20.5	3.5	10*	64	88843420500
25.0	3.8	10*	68	88843425000

*3 flattened shanks = effective holding

Tolerances			
D	Angle	d	L
z 9	- 1°	h9	± 1mm

Carbide = hardness 1800 HV to machine steels over 1300 N/mm², treated steels up to 60 HRC, abrasive tough steels, stainless steels, titanium alloys, hard bronze, inconel, nimonic, waspaloy, hard cast irons and all other metals, thermoplastics, nylon, PVC, laminated, graphite, reinforced polymer with glass or carbon fibers and ceramic glass.

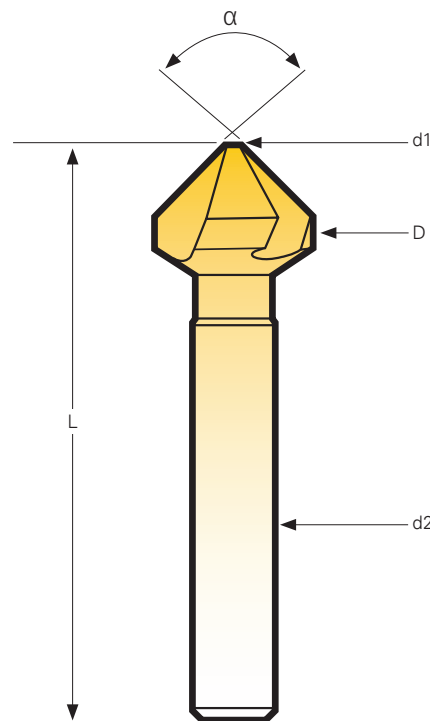
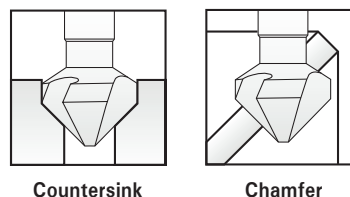

TRI-DENT Metric

90° Three Flute Countersinks

Three Flute Countersinks - Angle 90° Special for abrasion-resistant hard alloys						
Diameter (inch) (mm)		Capacity min/max	D	L	Cobalt + 436	M42/RedX 4936
0.248	6.3	0.051 – 0.248	0.197	1-3/4	84436063000	84493606300
0.327	8.3	0.071 – 0.327	0.236	1-3/4	84436083000	84493608300
0.410	10.4	0.087 – 0.410	0.236	1-3/4	84436104000	84493610400
0.488	12.4	0.098 – 0.488	0.315	2-1/4	84436124000	84493612400
0.650	16.5	0.110 – 0.650	0.394	2-3/8	84436165000	84493616500
0.807	20.5	0.118 – 0.807	0.394	2-1/2	84436205000	84493620500
0.984	25.0	0.126 – 0.984	0.394	2-5/8	84436250000	84493625000
1.220	31.0	0.138 – 1.220	0.472	2-3/4	84436310000	84493631000
1.969	50.0*	0.197 – 1.969	0.630	5	84436500000	84493650000

*3 flatted shanks

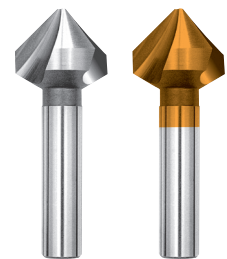

HSS-E 8% COBALT M42

NOTE:

All metric sizes are available. Call customer service for information or to place an order.

Countersinks - Angle 90° 3 Flutes						
Diameter (inch) (mm)		Capacity min/max	D	L	Carbide 8431	K15/Hard-H 8431-H
0.170	4.3	0.051 – .0170	0.157	1-9/16	88843104300	888431H0430†
0.209	5.3	0.051 – 0.209	0.157	1-9/16	88843105300	888431H0530†
0.248	6.3	0.051 – 0.248	0.197	1-3/4	88843106300	888431H0630†
0.327	8.3	0.071 – 0.327	0.236	1-3/4	88843108300	888431H0830†
0.410	10.4	0.087 – 0.410	0.236	1-3/4	88843110400	888431H1040
0.488	12.4*	0.098 – 0.488	0.315	2-1/4	88843112400	888431H1240
0.650	16.5*	0.110 – 0.650	0.394	2-3/8	88843116500	888431H1650
0.807	20.5*	0.118 – 0.807	0.394	2-1/2	88843120500	888431H2050
0.984	25.0*	0.126 – 0.984	0.394	2-5/8	88843125000	888431H2500
1.200	31.0*	0.138 – 1.220	0.472	2-3/4	88843131000	888431H3100

*Ø 12,4 – 31,0 = 3 flatted shanks

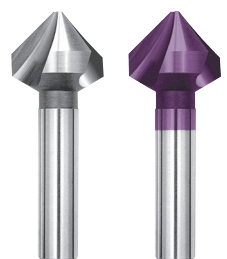

K15 SOLID CARBIDE

Long Series - Angle 90°							
Diameter (inch) (mm)		Capacity min/max	D	L	Cobalt 4303	M35/RedX 4933	Carbide 8431-L
0.248	6.3	0.051 – 0.248	0.236	3-5/16	84430316500	84493306300	888431L0630
0.327	8.3	0.071 – 0.327	0.315	3-3/8	84430308300	84493308300	888431L0830
0.410	10.4	0.087 – 0.410	0.394	3-1/2	84430310400	84493310400	888431L1040
0.488	12.4	0.098 – 0.488	0.394	4-1/4	84430312400	84493312400	888431L1240
0.650	16.5	0.110 – 0.650	0.630	4 - 7/16	84430316500	84493316500	888431L1650
0.807	20.5	0.118 – 0.807	0.360	4-1/2	84430320500	84493320500	888431L2050
0.984	25.0	0.126 – 0.984	0.788	4 -11/16	84430325000	84493325000	-



HSS-E COBALT M35

TRI-DENT

90° Three Flute Countersinks Anti-Vibration

Metric

Applications: **Countersinking and Chamfering**

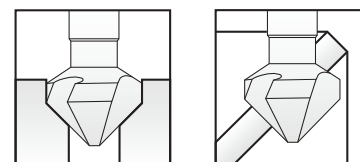

Countersink

Chamfer

The equal division 3 x 120° of the flutes offers good results in most materials.

For iron alloys, vibrations may happen and generate chatter.

These new **anti-vibration** countersinks with variable pitch flutes avoid this phenomenon.

HSS-E Cobalt = hardness 65 HRC, to machine steels up to 1000N/mm², cast iron up to 180 HB, copper, brass, bronze and aluminum.

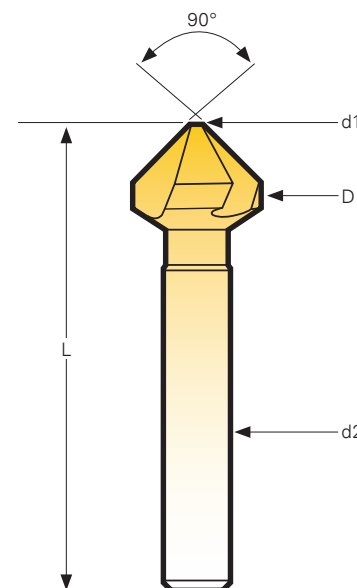

Three Flute Countersinks Anti-Vibration - Angle 90°					DIN 334-C	
D (mm)	d1 max	d2	L	HSS-E 43-A	TiN 483-A	
4.3	1.3	4	40	8443A043000	84483A04300	
5.3	1.5	4	40	8443A053000	84483A05300	
6.0	1.5	5	45	8443A060000	84483A06000	
6.3	1.5	5	45	8443A063000	84483A06300	
8.0	2.0	6	50	8443A080000	84483A08000	
8.3	2.0	6	50	8443A083000	84483A08300	
9.4	2.2	6	50	8443A094000	84483A09400	
10.0	2.5	6	50	8443A100000	84483A10000	
10.4	2.5	6	50	8443A104000	84483A10400	
11.5	2.8	8	56	8443A115000	84483A11500	
12.0	2.8	8	56	8443A120000	84483A12000	
12.4	2.8	8	56	8443A124000	84483A12400	
15.0	3.2	10	60	8443A150000	84483A15000	
16.5	3.2	10	60	8443A165000	84483A16500	
20.5	3.5	10	63	8443A205000	84483A20500	
25.0	3.8	10	67	8443A250000	84483A25000	
28.0	4	12	71	8443A280000	84483A28000	
30.0	4.2	12	71	8443A300000	84483A30000	
31.0	4.2	12	71	8443A310000	84483A31000	

Value Sets			
Composition	Quality	Code	EDP No.
5 cutters 10.4, 16.5 20.5, 25, 31	HSS-E TiN	43-A	8443A000000
		483-A	84483A00000
6 cutters 6.3, 8.3, 10., 12.4, 16.5, 20.5	HSS-E TiN	43-A	8443A000002
		483-A	84483A00002



To place an order or to learn more about Pilot Precision Products, contact customer service at 413-350-5200.

Single Flute Chamfering Cutters

Single Flute Chamfering Cutters¹ - Angle 90°

Diameter		Capacity min/max	d	L	Cobalt 421	M35/TiN 4821
(inch)	(mm)					
1/8	-	1/32 - 1/8	1/8	1-1/4	84421031700	84482103170
0.157	4	3/64 - 0.157	0.157	1-1/2	84421040000	84482104000
3/16	-	3/64 - 3.160	3/16	1-3/8	84421047600	84482104760
0.197	5	3/64 - 0.197	0.197	1-1/2	84421050000	84482105000
0.236	6	3/64 - 0.236	0.236	1-1/2	84421060000	84482106000
1/4	-	3/64 - 1/4	1/4	1-1/2	84421063500	84482106350
5/16	-	3/64 - 5/16	1/4	1-5/8	84421079300	84482107930
0.315	8	3/64 - 0.315	0.236	1-1/2	84421080000	84482108000
3/8	-	3/64 - 3/8	1/4	1-3/4	84421095200	84482109520
0.394	10	3/64 - 0.394	0.236	1-3/4	84421100000	84482110000
0.472	12	5/64 - 0.472	0.315	2	84421120000	84482112000
1/2	-	5/64 - 1/2	1/4	2	84421127000	84482112700
0.590	15	5/64 - 0.590	0.315	2-1/8	84421150000	84482115000
5/8	-	5/64 - 5/8	3/8	2-1/4	84421158700	84482115870
3/4	-	5/64 - 3/4	1/2	2-5/8	84421190500	84482119050
0.787	20	5/64 - 0.787	0.394	2-5/8	84421200000	84482120000
7/8	-	7/64 - 7/8	1/2	2-3/4	84421222200	84482122220
0.984	25	1/8 - 0.984	0.472	3	84421250000	84482125000
1	-	1/8 - 1.000	1/2	2-3/4	84421254000	84482125400
1.181	30	1/8 - 1.181	0.472	3-1/2	84421300000	84482130000
1-1/4	-	1/8 - 1-1/4	1/2	2-3/4	84421317500	84482131750
1.378	35	5/32 - 1.378	0.630 ¹	4	84421350000	84482135000
1.575	40	7/32 - 1.575	0.630 ¹	4-5/8	84421400000	84482140000
2.000	50	15/32 - 2.000	0.630 ¹	5	84421500000	84482150000

¹ Shank with 3 flats for better holding



HSS-E Cobalt M35

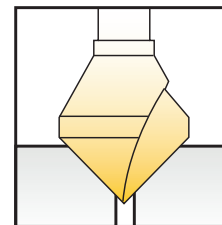

Single Flute Chamfering Cutters - Angle 100°

Diameter		Capacity min/max	d	L	Cobalt 425	M35/TiN 4825
(inch)	(mm)					
0.394	10	3/64 - 0.394	0.236	1-3/4	84425100000	84482510000
0.472	12	5/64 - 0.472	0.315	1-7/8	84425120000	84482512000
0.590	15	5/64 - 0.590	0.315	2-1/8	84425150000	84482515000
0.787	20	5/64 - 0.787	0.394	2-1/2	84425200000	84482520000
0.984	25	1/8 - 0.984	0.472	3	84425250000	84482525000
1.181	30	1/8 - 1.181	0.472	3-3/8	84425300000	84482530000



Single Flute Chamfering Cutters - Angle 120°

Diameter		Capacity min/max	d	L	Cobalt 423	M35/TiN 4823
(inch)	(mm)					
0.394	10	3/64 - 0.394	0.236	1-3/4	84423100000	84482310000
0.472	12	5/64 - 0.472	0.315	1-7/8	84423120000	84482312000
0.590	15	5/64 - 0.590	0.315	2	84423150000	84482315000
0.787	20	5/64 - 0.787	0.394	2-3/8	84423200000	84482320000
0.984	25	1/8 - 0.984	0.472	2-7/8	84423250000	84482325000
1.181	30	1/8 - 1.181	0.472	3-1/4	84423300000	84482330000

Metric Single Flute Countersink - Sets of 5 Pieces

Angle	Cobalt	M35/TiN	Composition
60°	84422000000	84482200000	10-15-20 25-30
82°	84424000000	84482400000	
90°	84421000000	84482100000	
100°	84425000000	84482500000	
120°	84423000000	84482300000	

Single Flute Countersink - Sets of 6 Pieces

Angle	Cobalt	M35/TiN	Composition
60°	84422000006	84482200006	1/4 - 5/16
82°	84424000006	84482400006	3/8 - 1/2
90°	84421000006	84482100006	5/8 - 3/4

90°, 100°,120° Single Flute Chamfering Cutters

The characteristics of the single flute chamfering cutters are similar to those of the deburring tools "with hole." They do vary on the following points:

- Greater countersinking capacity from the point to the outside diameter (up to Ø 30mm)
- Simultaneous drilling and countersinking on thin elements (laminates, aluminum, wood)

Constant finish-grind profile makes it possible to obtain many easy regrinds: a mere touch of the grinder to the tooth is sufficient

We recommend lubricating.



HSS-E Cobalt M35

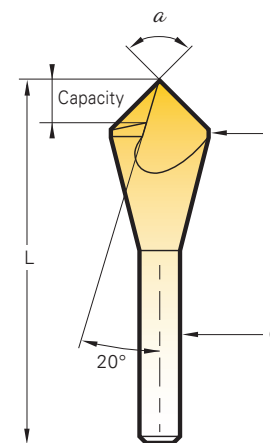
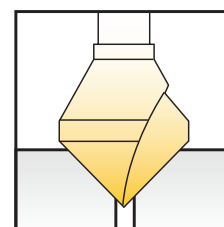

Single Flute Chamfering Cutters - Angles 60° and 82°							
Angle	Diameter		Capacity min/max	d	L	Cobalt 422	M35/TiN 4822
	(inch)	(mm)					
60°	1/8	-	1/32 - 1/8	1/8	1-1/4	84422031700	84482203170
	3/16	-	3/64 - 3/16	3/16	1-3/8	84422047600	84482204760
	0.236	6	3/64 - 0.236	0.236	1-5/8	84422060000	84482206000
	1/4	-	3/64 - 1/4	1/4	1-1/2	84422063500	84482206350
	5/16	-	3/64 - 5/16	1/4	1-5/8	84422079300	84482207930
	3/8	-	3/64 - 3/8	1/4	1-3/4	84422095200	84482209520
	0.394	10	3/64 - 0.394	0.236	1-7/8	84422100000	84482210000
	0.472	12	5/64 - 0.472	0.315	2-1/8	84422120000	84482212000
	1/2	-	5/64 - 1/2	1/4	2	84422127000	84482212700
	0.590	15	5/64 - 0.590	0.315	2-3/8	84422150000	84482215000
	5/8	-	5/64 - 5/8	3/8	2-1/4	84422158700	84482215870
	3/4	-	5/64 - 3/4	1/2	2-5/8	84422190500	84482219050
	0.787	20	5/64 - 0.787	0.394	2-7/8	84422200000	84482220000
	7/8	-	7/64 - 7/8	1/2	2-3/4	84422222200	84482222220
	0.984	25	1/8 - 0.984	0.472	3-3/8	84422250000	84482225000
	1	-	1/8 - 1	1/2	2-3/4	84422254000	84482225400
	1.181	30	1/8 - 1.181	0.472	3-5/8	84422300000	84482230000
	1-1/4	-	1/8 - 1-1/4	1/2	3	84422317500	84482231750
82°	1/8	-	1/32 - 1/8	1/8	1-1/4	84424031700	84482403170
	3/16	-	3/64 - 3/16	3/16	1-3/8	84424047600	84482404760
	0.236	6	3/64 - 0.236	0.236	1-5/8	84424060000	84482406000
	1/4	-	3/64 - 1/4	1/4	1-1/2	84424063500	84482406350
	5/16	-	3/64 - 5/16	1/4	1-5/8	84424079300	84482407930
	3/8	-	3/64 - 3/8	1/4	1-3/4	84424095200	84482409520
	0.394	10	3/64 - 0.394	0.236	1-3/4	84424100000	84482410000
	0.472	12	5/64 - 0.472	0.315	2	84424120000	84482412000
	1/2	-	5/64 - 1/2	1/4	2	84424127000	84482412700
	0.590	15	5/64 - 0.590	0.315	2-1/4	84424150000	84482415000
	5/8	-	5/64 - 5/8	3/8	2-1/4	84424158700	84482415870
	3/4	-	5/64 - 3/4	1/2	2-5/8	84424190500	84482419050
	0.787	20	5/64 - 0.787	0.394	2-5/8	84424200000	84482420000
	7/8	-	7/64 - 7/8	1/2	2-3/4	84424222200	84482422220
	0.984	25	1/8 - 0.984	0.472	3	84424250000	84482425000
	1	-	1/8 - 1	1/2	2-3/4	84424254000	84482425400
	1.181	30	1/8 - 1.181	0.472	3-1/2	84424300000	84482430000
	1-1/4	-	1/8 - 1-1/4	1/2	2-3/4	84424317500	84482431750

Note: 30° and 45° angles are metric standard. Call 413-350-5200 for information.

Tolerances			
D	Angle	d	L
± .03	- 1°	h9	± 1mm

60° & 82° Zero Flute Deburring Tool with Hole

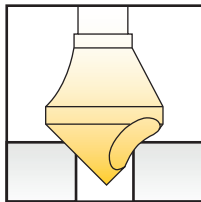

The deburring tool "with hole" is specially designed for countersinking and chamfering light metals and plastics.

The surface obtained is smooth and without burrs. We recommend lubricating.

Metric Zero Flute Deburring Tool with Hole - Angle 90°

#	Diameter (inch)	Diameter (mm)	Capacity min/max	d	L	Cobalt 411	M352/TiN 4811
0	1/4 ¹	-	5/64 - 3/16	1/4	1-3/4	84411063500	84481106350
	0.394	10	5/32 - 11/32	0.236	1-3/4	84411100000	84481110000
1	7/16	-	7/32 - 13/32	1/4	1-3/4	84411112000	84481111200
2	9/16	-	1/4 - 1/2	1/4	2	84411140000	84481114000
	0.590	15	1/4 - 9/16	0.315	2-1/4	84411150000	84481115000
	0.787	20	5/16 - 11/16	0.394	2-1/2	84411200000	84481120000
3	13/16	-	5/16 - 11/16	1/2	2-5/8	84411204000	84481120400
	0.984	25	3/8 - 7/8	0.472	3	84411250000	84481125000
	1.102	28	7/16 - 1	0.472	3-3/8	84411280000	84481128000
	1.181	30	1/2 - 1-1/8	0.472	3-1/2	84411300000	84481130000
4	1-3/16	-	1/2 - 1-1/8	1/2	3-1/2	84411301000	84481130100
	1.378	35	9/16 - 1-5/16	0.630 ²	4	84411350000	84481135000
	1.575	40	5/8 - 1-1/2	0.630 ²	4-5/8	84411400000	84481140000
	1.969	50	3/4 - 1-7/8	0.630 ²	5	84411500000	84481150000

¹ Double end cutter

² Shanks with 3 flats for better holding

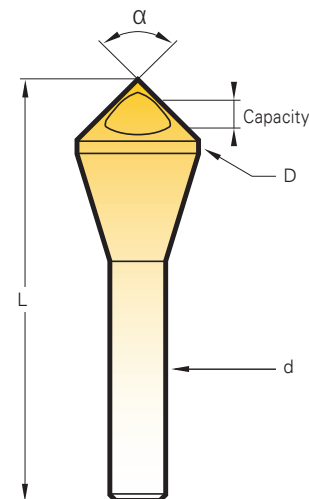

Metric Zero Flute Deburring Tool with Hole - Angles 60°, 82°, 100° and 120°

Angle	#	Diameter (inch)	Diameter (mm)	Capacity min/max	d	L	Cobalt
60° 412	0	1/4 ¹	-	7/64 - 3/16	1/4	1-3/4	84412063500
		0.394	10	3/16 - 11/32	0.236	2	84412100000
	1	7/16	-	3/16 - 3/8	1/4	1-3/4	84412112000
	2	9/16	-	9/32 - 1/2	1/4	2	84412140000
		0.590	15	5/16 - 9/16	0.315	2-3/8	84412150000
		0.787	20	3/8 - 11/16	0.394	2-7/8	84412200000
	3	13/16	-	3/8 - 11/16	1/2	2-5/8	84412204000
		0.984	25	1/2 - 7/8	0.472	3-3/8	84412250000
		1.181	30	9/16 - 1 - 1/8	0.472	3-5/8	84412300000
		1-3/16	-	9/16 - 1 - 1/8	1/2	3-1/2	84412301000
82° 414		1.378	35	11/16 - 1 - 5/16	0.630	4-1/2	84412350000
	0	1/4 ¹	-	5/64 - 3/16	1/4	1-3/4	84414063500
		0.394	10	5/32 - 11/32	0.236	1-3/4	84414100000
	1	7/16	-	7/32 - 13/32	1/4	1-3/4	84414112000
	2	9/16	-	1/4 - 1/2	1/4	2	84414140000
		0.590	15	1/4 - 9/16	0.315	2-1/4	84414150000
		0.787	20	5/16 - 11/16	0.394	2-1/2	84414200000
	3	13/16	-	5/16 - 11/16	1/2	2-5/8	84414204000
		0.984	25	3/8 - 7/8	0.472	3	84414250000
		1.181	30	1/2 - 1-1/8	0.472	3-1/2	84414300000
100° 415	4	1-3/16	-	1/2 - 1-1/8	1/2	3-1/2	84414301000
		1.378	35	9/16 - 1-5/16	0.630	4	84414350000
		0.394	10	5/32 - 11/32	0.236	1-3/4	84415100000
		0.590	15	1/4 - 9/16	0.315	2-1/8	84415150000
		0.787	20	9/32 - 11/16	0.394	2-1/2	84415200000
		0.984	25	11/32 - 7/8	0.472	3	84415250000
120° 413		1.181	30	7/16 - 1-1/16	0.472	3-3/8	84415300000
		1.387	35	1/2 - 1-5/16	0.630	4	84415350000
		0.394	10	5/32 - 11/32	0.236	1-3/4	84413100000
		0.590	15	1/4 - 9/16	0.315	2	84413150000
		0.787	20	9/32 - 11/16	0.394	2-3/8	84413200000
		0.984	25	11/32 - 7/8	0.472	2-7/8	84413250000
	1.181	30	7/16 - 1-1/16	0.472	3-1/4	84413300000	
	1.378	35	1/2 - 1-5/16	0.630	3-3/4	84413350000	

¹ Double end cutter

² Shanks with 3 flats for better holding

Tolerances

D	Angle	d	L
± .03	- 1°	h9	± 1mm



Metric Single Flute Countersink Sets - 5 pieces

Angle	EDP No.	Composition
60°	84412000000	Ø 10-15-20-25-30 mm
	84412000005	# 0-1-2-3-4
82°	84414000000	Ø 10-15-20-25-30 mm
	84414000005	# 0-1-2-3-4
90°	84411000000	Ø 10-15-20-25-30 mm
	84481100000-TiN	Ø 10-15-20-25-30 mm
	84411000002	Ø 10-15-20-28-35 mm
	84411000005	# 0-1-2-3-4
100°	84415000000	Ø 10-15-20-25-30 mm
	84415000005	# 0-1-2-3-4
120°	84413000000	Ø 10-15-20-25-30 mm

Deburring Countersinking - Performance

Performance

Use Recommendations

Example:

3/4" - .750 Diameter 3 Flute to Countersink 304 SS

SFM = Speed : Surface Feet Per Minute

IPM = Feed : Inches Per Minute

RPM = $\frac{SFM \times 12}{3.14 \times Diameter}$

$$RPM = \frac{45 \times 12}{3.14 \times .75} = \frac{540}{2.35} = 230 \text{ RPM}$$

			Deburring Countersinking								Contouring							
			HSS. Co =+TiN		HSS. Co =+TiN		HSS. Co =+TiN		HSS. .8% Co +Red'X		Carbure/Carbide +Hard'X		HSS. Co =+TiN		HSS. .8% Co +Red'X		Carbure/Carbide +Hard'X	
Material	SFM		115-148	115-148	115-148	115-148	55-70	55-70	112-145	112-145	128-256	128-256	55-70	55-70	112-145	112-145	128-256	128-256
Steel < 81 HRB (B)	Ø10	IPM	6.5	6.5	6.5	6.5	3.4	3.4	6.5	6.5	10.0	10.0	3.4	3.4	6.5	6.5	10.0	10.0
	Ø20	IPM	3.4	3.4	3.4	3.4	1.8	1.8	3.4	3.4	5.0	5.0	1.8	1.8	3.4	3.4	5.0	5.0
	Ø30	IPM	2.0	2.0	2.0	2.0	1.2	1.2	2.0	2.0	3.4	3.4	1.2	1.2	2.0	2.0	3.4	3.4
Steel < 24 Rc	SFM		65-95	65-95	65-95	65-95	32-48	32-48	65-95	65-95	95-160	95-160	32-48	32-48	65-95	65-95	95-160	95-160
	Ø10	IPM	4.3	4.3	4.3	4.3	2.4	2.4	4.3	4.3	6.6	6.6	2.4	2.4	4.3	4.3	6.6	6.6
	Ø20	IPM	2.0	2.0	2.0	2.0	1.2	1.2	2.0	2.0	3.4	3.4	1.2	1.2	2.0	2.0	3.4	3.4
Steel 24 - 32 Rc	Ø30	IPM	1.4	1.4	1.4	1.4	0.8	0.8	1.4	1.4	2.4	2.4	0.8	0.8	1.4	1.4	2.4	2.4
	SFM		48-64	48-64	48-64	48-64	25-38	25-38	48-64	48-64	64-128	64-128	25-38	25-38	48-64	48-64	64-128	64-128
	Ø10	IPM	2.0	2.0	2.0	2.0	1.4	1.4	2.0	2.0	4.0	4.0	1.4	1.4	2.0	2.0	4.0	4.0
Stainless Steel 32 - 41 Rc	Ø20	IPM	1.4	1.4	1.4	1.4	1.0	1.0	1.4	1.4	2.4	2.4	1	1.0	1.4	1.4	2.4	2.4
	Ø30	IPM	1.0	1.0	1.0	1.0	0.6	0.6	1.0	1.0	1.8	1.8	0.6	0.6	1.0	1.0	1.8	1.8
	SFM		38-48	38-48	38-48	38-48	20-32	20-32	38-48	38-48	64-128	64-128	20-32	20-32	38-48	38-48	64-128	64-128
Abrasion Resistant Steel	Ø10	IPM	1.8	1.8	1.8	1.8	1.2	1.2	1.8	1.8	4.0	4.0	1.2	1.2	1.8	1.8	4.0	4.0
	Ø20	IPM	1.0	1.0	1.0	1.0	0.6	0.6	1.0	1.0	2.4	2.4	0.6	0.6	1.0	1.0	2.4	2.4
	Ø30	IPM	0.8	0.8	0.8	0.8	0.3	0.3	0.8	0.8	1.6	1.6	0.3	0.3	0.8	0.8	1.6	1.6
Inconel	SFM									38-48	48-64	48-64					38-48	48-64
	Ø10	IPM								1.6	2.0	2.0					1.6	2.0
	Ø20	IPM								1.2	1.4	1.4					1.2	1.4
Cast Iron	Ø30	IPM								0.8	1.0	1.0					0.8	1.0
	SFM		64-128	64-128	64-128	64-128	48-80	48-80	64-128	64-128	128-256	128-256	48-80	48-80	64-128	64-128	128-256	128-256
	Ø10	IPM	5.0	5.0	5.0	5.0	2.8	2.8	5.0	5.0	0.3	0.3	2.8	2.8	5.0	5.0	0.3	0.3
Aluminium	Ø20	IPM	3.0	3.0	3.0	3.0	1.6	1.6	3.0	3.0	6.0	6.0	1.6	1.6	3.0	3.0	6.0	6.0
	Ø30	IPM	2.0	2.0	2.0	2.0	1.2	1.2	2.0	2.0	4.0	4.0	1.2	1.2	2.0	2.0	4.0	4.0
	SFM		160-190	160-190	160-190	160-190	112-145	112-145	160-190	160-190	128-320	128-320	112-145	112-145	160-190	160-190	128-320	128-320
Bronze Brass	Ø10	IPM	10.0	10.0	10.0	10.0	7.8	7.8	10.0	10.0	13.8	13.8	7.8	7.8	10.0	10.0	13.8	13.8
	Ø20	IPM	7.0	7.0	7.0	7.0	5.2	5.2	7.0	7.0	9.0	9.0	5.2	5.2	7.0	7.0	9.0	9.0
	Ø30	IPM	6.0	6.0	6.0	6.0	4.3	4.3	6.0	6.0	7.8	7.8	4.3	4.3	6.0	6.0	7.8	7.8
Copper	SFM		96-128	96-128	96-128	96-128	65-95	65-95	96-128	96-128			65-95	65-95	96-128	96-128		
	Ø10	IPM	6.0	6.0	6.0	6.0	4.7	4.7	6.0	6.0			4.7	4.7	6.0	6.0		
	Ø20	IPM	4.3	4.3	4.3	4.3	3.4	3.4	4.3	4.3			3.4	3.4	4.3	4.3		
Laminated	Ø30	IPM	3.5	3.5	3.5	3.5	2.8	2.8	3.5	3.5			2.8	2.8	3.5	3.5		
	SFM		65-95	65-95	65-95	65-95	48-80	48-80	65-95	65-95	160-256	160-256	48-80	48-80	65-95	65-95	160-256	160-256
	Ø10	IPM	4.7	4.7	4.7	4.7	3.75	3.75	4.7	4.7	12.0	12.0	3.75	3.75	4.7	4.7	12.0	12.0
Nylon, PVC Plastics	Ø20	IPM	3.0	3.0	3.0	3.0	2.4	2.4	3.0	3.0	7.8	7.8	2.4	2.4	3.0	3.0	7.8	7.8
	Ø30	IPM	2.6	2.6	2.6	2.6	1.8	1.8	2.6	2.6	7.0	7.0	1.8	1.8	2.6	2.6	7.0	7.0
	SFM		160-320	160-320	160-320	160-320	112-224	112-224	112-224	112-224			112-224	112-224	112-224	112-224		
Nylon, PVC Plastics	Ø10	IPM	16.0	16.0	16.0	16.0	12.0	12.0	12.0	12.0			12.0	12.0	12.0	12.0		
	Ø20	IPM	12.0	12.0	12.0	12.0	7.8	7.8	7.8	7.8			7.8	7.8	7.8	7.8		
	Ø30	IPM	10.0	10.0	10.0	10.0	6.0	6.0	6.0	6.0			6.0	6.0	6.0	6.0		

TRI-DENT

Hand Countersinks

Countersinks with 3 Flatted Shanks* - Angle 90°

Diameter (inch) (mm)		Capacity min/max	d	L	Cobalt 437	M35/TiN 4837
0.488	12.4	0.098 - 0.488	0.315	2 - 1/4	84437124000	84483712400
0.597	14.4	0.098 - 0.597	0.315	2 - 1/4	84437144000	84483714400
0.650	16.5	0.110 - 0.650	0.394	2 - 3/8	84437165000	84483716500
0.807	20.5	0.118 - 0.807	0.394	2 - 1/2	84437205000	84483720500
0.984	25.0	0.126 - 0.984	0.394	2 - 5/8	84437250000	84483725000
1.220	31.0	0.138 - 1.220	0.472	2 - 3/4	84437310000	84483731000
1.339	34.0	0.177 - 1.339	0.630	4	84437340000	84483734000
1.378	35.0	0.177 - 1.378	0.630	4	84437350000	84483735000
1.457	37.0	0.177 - 1.457	0.630	4 - 5/8	84437370000	84483737000
1.575	40.0	0.177 - 1.575	0.630	4 - 5/8	84437400000	84483740000
1.969	50.0	0.197 - 1.969	0.630	5	84437500000	84483750000
2.480	63.0	0.394 - 2.480	0.630	5 - 1/2	84437630000	84483763000
3.150	80.0	0.551 - 3.150	0.630	6 - 1/2	84437800000	84483780000

This highly productive countersinking cutter is a much-improved version of the traditional multiflute milling cutter. It offers the following benefits:

- Grooves opened wide to allow for greater chip removal
- High positive cut
- Constant profile relief (for many regrinds)
- Self-centering countersink
- Work without vibration

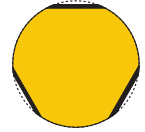

Tool dimensions are adapted to countersink the 82° and 90° caps crews. Lubrication is recommended.



Hand Countersinks - HSS-E Cobalt M35

Diameter (inch) (mm)		Capacity min/max	Angle 82° Cobalt 438	Angle 90° Cobalt 430
0.488	12.4	0.118 - 0.488	84438124000	84430124000
0.650	16.5	0.157 - 0.650	84438165000	84430165000
0.807	20.5	0.157 - 0.807	84438205000	84430205000
0.984	25.0	0.197 - 0.984	84438250000	84430250000
1.220	31.0	0.197 - 1.220	84438310000	84430310000

Universal Auto-Lock Chuck

Handle	Capacity min/max	EDP No.
Ergonomic	3/64 - 8mm	84400200000
Large	3/64 - 1/2"	84400100000

To hold any straight shank tool, for use by hand.



Hand Countersink Sets - HSS-E Cobalt M35

84431000003 ¹	6.3 - 8.3 - 10.4 - 12.4 - 16.5 - 20.5 - 25mm
84431000004 ¹	4.3 - 5.3 - 6.3 - 8.3 - 10.4 - 12.4 - 16.5 - 20.5 - 25 - 31mm
88843100000	10.4 - 16.5 - 20.5 - 25.0 - 31 mm carbide
84431000006 ²	6.3 - 12.4 - 16.5 - 20.5mm
84483100006 TiN ²	

¹ Set supplied with 1 auto-lock chuck handle Code 4001

² Set supplied with 8mm auto-lock chuck handle Code 4002

Auto Body Drill Bits to Disconnect Spot Welds

Hard'X
AlTiN Latuma

The machining of hard sheets has to be done with coated tools.
The high-performance series **8203-H** is made from **Hard'X** coated carbide.

- Easy to start
- Long lasting
- Will spot and drill one panel only, without walking

These short drills are specially designed to be used with these two types of hand type pneumatic disconnecter tools:

- With swan-neck = Magafor 202
- With revolver-handle = Magafor 203

Flatted shanks with 60° taper for a good location in the disconnecter.

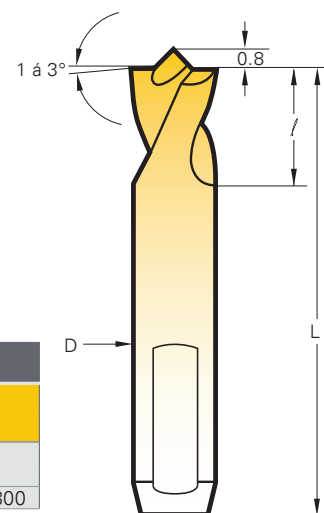
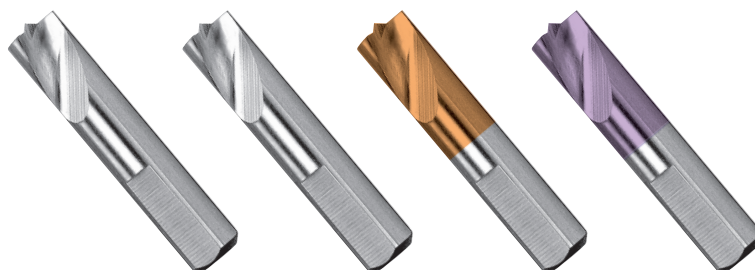

Short Series

Diameter		L	/	Cobalt 202	Cobalt 203	M35/Red'X 2903	K15/Hard'X 8203-H
(inch)	(mm)						
0.236	6	1-3/4	0.590	-	82203060000	-	-
5/16	8	1-1/2	0.590	8220208000	-	-	-
5/16	8	1-3/4	0.590	-	82203080000	82290308000	888203H0800

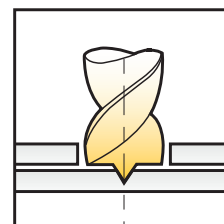

Long Series

Diameter		d	L	Cobalt 201	M35/Red'X 2901	Brazed Carbide 8201
(inch)	(mm)					
0.236	6	2-5/8	1.100	82201060000	82290106000	-
0.275	7	2-7/8	1.340	82201070000	82290107000	-
0.314	8	-	-	-	-	88820108000
5/16	-	3-1/8	1.450	82201080000	82290108000	-
0.394	10	3-1/2	1.690	82201100000	82290110000	-

Tolerances

D	L	/
h8	± 1	+1

The centering point grants perfect drilling without any drifting or walking. Thanks to the special sharpening, the first sheet will be bored without damage to the second one. This design allows for excellent penetration, a high resistance to wear and a great many regrinds. The carbide spot-weld drills are designed to machine the new, very-high elastic limit sheet metal (VHEL).

High Precision Reamers

How to Choose Standard Inch Reamers					
Examples	Reaming (Hole)			Reamer (Tool)	
	Ø	Tolerance (inch)	Tolerance (inch)	Ø	Tolerance-inch
1	1/64"	+0.00006 -0.00012	0.01568 0.01550	EDP No. 861000395 0.01551"	0.01559 0.01551
2	1/32"	+0.0001 -0.0002	0.03135 0.03105	EDP No. 86000079 0.03110"	0.03122 0.03110
3	1/16"	+0.0004 -0.0001	0.0629 0.0624	EDP No. 86000159 0.0626"	0.06272 0.06260

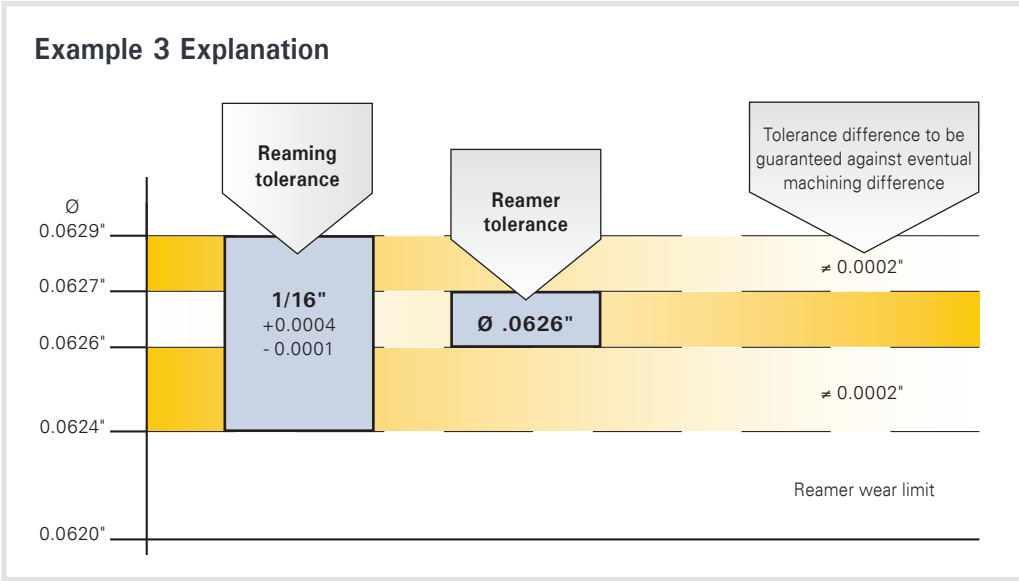

How to Choose Metric Reamers Code 8610 – 8600 : page 85–91									
Tolerance	Ø 2	Ø 3	Ø 4	Ø 5	Ø 6	Ø 8	Ø 10	Ø 12	Ø 14
D 10	2.04	3.04	4.05	5.06	6.06	8.07	10.08	12.10	14.10
E 8	2.02	3.02	4.03	5.03	6.03	8.03	10.03	12.04	14.04
E 9	2.03	3.03	4.04	5.04	6.04	8.05	10.05	12.06	14.06
F 7	2.01	3.01	4.01	5.01	6.01	8.02	10.02	12.02	14.02
F 8	2.01	3.01	4.02	5.02	5.02	8.02	10.02	12.03	14.03
G 7	2.00	3.00	4.01	5.02	5.02	8.01	10.01	12.01	14.01
H 6	2.00	3.01	4.00	5.00	6.00	8.00	10.00	12.00	14.00
H 8	2.01	3.01	4.01	5.01	6.01	8.01	10.01	12.01	14.01
H 9	2.01	2.99	4.02	5.02	6.02	8.02	10.02	12.03	14.03
M 7	1.99	2.99	3.99	4.99	5.99	7.99	9.99	11.99	13.99
N 7	1.99	2.99	3.99	4.99	5.99	7.98	9.98	11.98	13.98
P 7	1.99	2.99	3.98	4.98	5.98	7.98	9.98	11.97	13.97
R 7	1.98	2.98	3.98	4.98	5.98	7.98	9.98	11.97	13.97

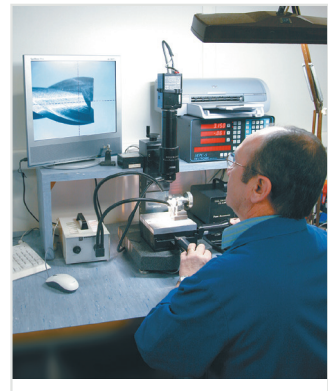

Reamers with Coolant Thru for Blind Holes

8670 Series

*Floating Holders available on pg. 73

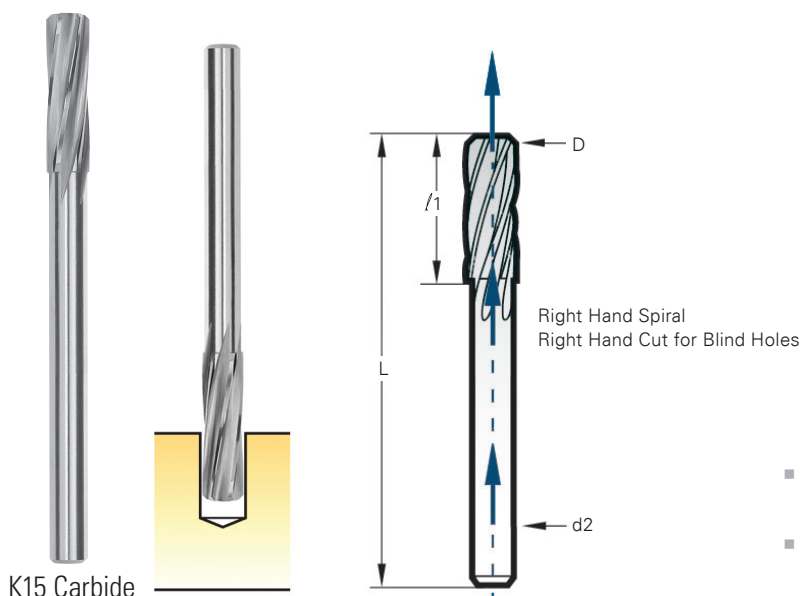

- Central oil feeding: the lubricant is fed directly into the hole to ream
- Right hand spiral - improved removal of swarf and coolant flow

8670 Series

EDP No.	Diameter		L	f1	d2	Wire/Frac
	(inch)	(mm)				
88867003900	0.1535	3.90	2.05	0.787	0.1575	
88867004000	0.1575	4.00	2.05	0.787	0.1575	
88867004100	0.1614	4.10	2.05	0.787	0.1575	
88867004200	0.1654	4.20	2.05	0.787	0.1575	
88867004300	0.1693	4.30	2.05	0.787	0.1575	
88867004400	0.1732	4.40	2.05	0.787	0.1575	
88867004500	0.1772	4.50	2.05	0.787	0.1575	
88867004600	0.1811	4.60	2.05	0.787	0.1575	
88867004700	0.1850	4.70	2.05	0.787	0.1575	
88867004762	0.1875	4.762	2.05	0.787	0.1575	3/16"
88867004800	0.1890	4.80	2.48	0.866	0.1575	
88867004900	0.1929	4.90	2.48	0.866	0.1575	
88867005000	0.1969	5.00	2.48	0.866	0.1575	
88867005100	0.2008	5.10	2.48	0.866	0.1575	
88867005200	0.2047	5.20	2.48	0.866	0.1575	
88867005300	0.2087	5.30	2.48	0.866	0.1575	
88867005400	0.2126	5.40	2.48	0.866	0.1575	
88867005500	0.2165	5.50	2.48	0.866	0.1575	
88867005600	0.2205	5.60	2.48	0.866	0.1575	
88867005700	0.224	5.70	2.48	0.866	0.1575	
88867005800	0.2284	5.80	2.48	0.866	0.1575	
88867005900	0.2323	5.90	2.48	0.866	0.1969	
88867006000	0.2362	6.00	2.48	0.866	0.1969	
88867006100	0.2402	6.10	2.48	0.866	0.1969	
88867006200	0.2241	6.20	2.48	0.866	0.1969	
88867006300	0.2480	6.30	2.48	0.866	0.1969	
88867006350	0.2500	6.35	2.48	0.866	0.1969	E / 1/4"
88867006400	0.2520	6.40	2.48	0.866	0.1969	
88867006500	0.2259	6.50	2.48	0.866	0.1969	
88867006600	0.2598	6.60	2.48	0.866	0.1969	
88867006700	0.2638	6.70	2.80	0.984	0.248	
88867006800	0.2677	6.80	2.80	0.984	0.248	
88867006900	0.2717	6.90	2.80	0.984	0.248	
88867007000	0.2756	7.00	2.80	0.984	0.248	
88867007100	0.2795	7.10	2.80	0.984	0.248	
88867007200	0.2835	7.20	2.80	0.984	0.248	
88867007300	0.2874	7.30	2.80	0.984	0.248	
88867007400	0.2913	7.40	2.80	0.984	0.248	
88867007500	0.2756	7.50	2.80	0.984	0.248	
88867007600	0.2992	7.60	2.80	0.984	0.248	
88867007700	0.3031	7.70	2.80	0.984	0.248	
88867007800	0.3071	7.80	2.80	0.984	0.248	
88867007900	0.3110	7.90	2.80	0.984	0.248	
88867007937	0.3125	7.937	2.80	0.984	0.248	5/16"

8670 Series

EDP No.	Diameter		L	f1	d2	Wire/Frac
	(inch)	(mm)				
88867008000	0.3150	8.00	2.80	0.984	0.248	
88867008100	0.3189	8.10	2.80	0.984	0.248	
88867008200	0.3328	8.20	2.80	0.984	0.248	
88867008300	0.3268	8.30	2.80	0.984	0.248	
88867008400	0.3307	8.40	2.80	0.984	0.248	
88867008500	0.3346	8.50	2.80	0.984	0.248	
88867008600	0.3386	8.60	2.80	0.984	0.315	
88867008700	0.3425	8.70	2.80	0.984	0.315	
88867008800	0.3465	8.80	2.80	0.984	0.315	
88867008900	0.3504	8.90	2.80	0.984	0.315	
88867009000	0.3543	9.00	2.80	0.984	0.315	
88867009100	0.3583	9.10	2.80	0.984	0.315	
88867009200	0.3543	9.20	2.80	0.984	0.315	
88867009300	0.3661	9.30	2.80	0.984	0.315	
88867009400	0.3701	9.40	2.80	0.984	0.315	
88867009500	0.3740	9.50	2.80	0.984	0.315	
88867009525	0.3750	9.525	2.80	0.984	0.315	3/8"
88867009600	0.3780	9.60	2.80	0.984	0.315	
88867009700	0.3819	9.70	2.80	0.984	0.315	
88867009800	0.3858	9.80	2.80	0.984	0.315	
88867009900	0.3897	9.90	2.80	0.984	0.315	
88867010000	0.3937	10.00	2.80	0.984	0.315	
88867010100	0.3976	10.10	2.80	0.984	0.315	
88867010200	0.4016	10.20	2.80	0.984	0.315	
88867010300	0.4055	10.30	2.80	0.984	0.315	
88867010400	0.4094	10.40	2.80	0.984	0.315	
88867010500	0.4134	10.50	2.80	0.984	0.315	
88867010600	0.4173	10.60	2.80	0.984	0.315	
88867010700	0.4213	10.70	3.15	1.102	0.394	
88867010800	0.4252	10.80	3.15	1.102	0.394	
88867010900	0.4291	10.90	3.15	1.102	0.394	
88867011000	0.4331	11.00	3.15	1.102	0.394	
88867011100	0.4370	11.10	3.15	1.102	0.394	
88867011112	0.4375	11.112	3.15	1.102	0.394	7/16"
88867011200	0.4409	11.20	3.15	1.102	0.394	
88867011300	0.449	11.30	3.15	1.102	0.394	
88867011400	0.4488	11.40	3.15	1.102	0.394	
88867011500	0.4528	11.50	3.15	1.102	0.394	
88867011600	0.4567	11.60	3.15	1.102	0.394	
88867011700	0.4606	11.70	3.15	1.102	0.394	
88867011800	0.4646	11.80	3.15	1.102	0.394	
88867011900	0.4685	11.90	3.15	1.102	0.394	15/32"
88867012000	0.4724	12.00	3.15	1.102	0.394	-
88867012700	0.5000	12.70	3.15	1.102	0.394	1/2"

High Precision Carbide Micro-Reamers

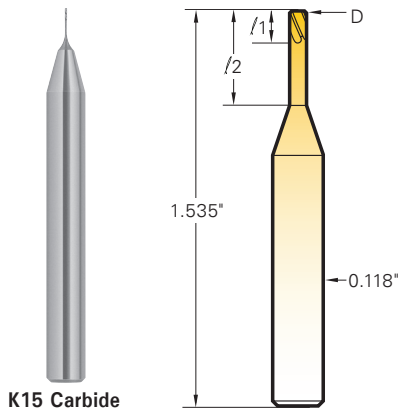

Micro-reamers are manufactured and stocked in all diameters at every 0.0002" increment. Their reinforced shank offers a greater stability necessary for these high precision tools.

Magaforce 8610 Micro-Precision		
D 0.0002" increment	/1	/2
0.0079 to 0.0096	0.036	0.079
0.0098 to 0.0116	0.043	0.098
0.0118 to 0.0136	0.055	0.118
0.0138 to 0.0156	0.067	0.138
0.0157 to 0.0195	0.079	0.157
0.0197 to 0.0234	0.091	0.197

For Magaforce 8610 EDP numbers, see below

Tolerances - inch	
H4	± 0.00004

K15 Carbide — 6.5 – 7% Cobalt (0.600 – 0.008mm grain size)

4 flutes, 20° left spiral, right hand cut

8610 Series			
EDP No.	(mm)	Decimal	Wire
88861000200	0.200	0.0079	92
88861000205	0.205	0.0081	
88861000210	0.210	0.0083	91
88861000215	0.215	0.0085	
88861000220	0.220	0.0087	90
88861000225	0.225	0.0089	
88861000230	0.230	0.0091	89
88861000235	0.235	0.0093	
88861000240	0.240	0.0094	88
88861000245	0.245	0.0096	
88861000250	0.250	0.0098	
88861000255	0.255	0.0100	87
88861000260	0.260	0.0102	
88861000265	0.265	0.0104	86
88861000270	0.270	0.0106	
88861000275	0.275	0.0108	
88861000280	0.280	0.0110	85
88861000285	0.285	0.0112	
88861000290	0.290	0.0114	84
88861000295	0.295	0.0116	
88861000300	0.300	0.0118	
88861000305	0.305	0.0120	83
88861000310	0.310	0.0122	
88861000315	0.315	0.0124	82
88861000320	0.320	0.0126	
88861000325	0.325	0.0128	
88861000330	0.330	0.0130	81

8610 Series			
EDP No.	(mm)	Decimal	Wire
88861000335	0.335	0.0132	
88861000340	0.340	0.0134	80
88861000345	0.345	0.0136	
88861000350	0.350	0.0138	
88861000355	0.355	0.0140	
88861000360	0.360	0.0142	
88861000365	0.365	0.0144	79
88861000370	0.370	0.0146	
88861000375	0.375	0.0148	
88861000380	0.380	0.0150	
88861000385	0.385	0.0152	
88861000390	0.390	0.0154	
88861000395	0.395	0.0156	
88861000400	0.400	0.0157	
88861000405	0.405	0.0159	78
88861000410	0.410	0.0161	
88861000415	0.415	0.0163	
88861000420	0.420	0.0165	
88861000425	0.425	0.0167	
88861000430	0.430	0.0169	
88861000435	0.435	0.0171	
88861000440	0.440	0.0173	
88861000445	0.445	0.0175	
88861000450	0.450	0.0177	
88861000455	0.455	0.0179	77
88861000460	0.460	0.0181	
88861000465	0.465	0.0183	-

8610 Series			
EDP No.	(mm)	Decimal	Wire
88861000470	0.470	0.0185	
88861000475	0.475	0.0187	
88861000480	0.480	0.0189	
88861000485	0.485	0.0191	
88861000490	0.490	0.0193	
88861000495	0.495	0.0195	
88861000500	0.500	0.0197	
88861000505	0.505	0.0199	76
88861000510	0.510	0.0201	
88861000515	0.515	0.0203	
88861000520	0.520	0.0205	
88861000525	0.525	0.0207	
88861000530	0.530	0.0209	75
88861000535	0.535	0.0211	
88861000540	0.540	0.0213	
88861000545	0.545	0.0215	
88861000550	0.550	0.0217	
88861000555	0.555	0.0219	
88861000560	0.560	0.0220	
88861000565	0.565	0.0222	
88861000570	0.570	0.0224	74
88861000575	0.575	0.0226	
88861000580	0.580	0.0228	
88861000585	0.585	0.0230	
88861000590	0.590	0.0232	
88861000595	0.595	0.0234	

All reamers come with 10° left hand spiral/right cut flute, designed for thru holes to optimally flush out chips for improved tool life and surface finish.

High Precision 8600 Miniature Reamers

*Floating Holders available on pg. 73

Magaforce 8600 Micro-Precision				
D 0.0002" increment	f1	f2	L	d2
0.0236 to 0.0413	0.275	0.393	1.300	D
0.0417 to 0.0610	0.393	0.944	1.580	D
0.0614 to 0.0929	0.433	1.220	1.970	D
0.0933 to 0.1476	0.590	1.500	2.250	D
0.1480 to 0.1673	0.748	1.930	2.950	0.158
0.1677 to 0.1870	0.827	2"	3.150	0.177
0.1874 to 0.2087	0.906	2.320	3.390	0.197
0.2091 to 0.2284	1.024	2.559	3.660	0.217
0.2288 to 0.2638	1.102	2.795	3.980	0.236
0.2642 to 0.2972	1.220	3.071	4.290	0.276
0.2976 to 0.3366	1.299	3.307	4.610	0.315
0.3370 to 0.3760	1.417	3.465	4.920	0.354
0.3763 to 0.3957	1.496	3.819	5.236	0.394
0.3961 to 0.4350	1.496	3.819	5.236	0.394
0.4354 to 0.4744	1.732	4.331	5.945	0.472
0.4748 to 0.5138	1.732	4.331	5.945	0.472
0.5535 to 0.5890	1.969	4.4.09	6.378	0.551
0.5929 to 0.7500	2.047	4.606	6.693	0.630
0.7468 to 0.7500	2.283	5.354	7.441	0.630

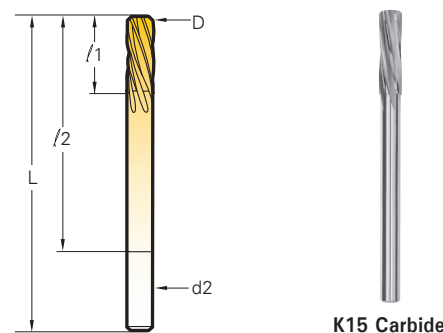

All reamers have a 45° chamfer lead
 Ø 0.0236" to 0.0929 = 4 flutes, Ø 0.0933" to .5138= 6 flutes,
10° left spiral/right hand cut for thru holes.

For Magaforce 8600 EDP numbers see below

Tolerances		
	(mm)	(inch)
H7	0.60 – 3.00	0 + .00012
H8	3.00 – 6.00	0 + .00016
H9	6.00 – 19.05	0 + .00020

8600 Series			8600 Series			
EDP No.	(mm)	Decimal	EDP No.	(mm)	Decimal	Wire
88860000600	0.60	0.0236	88860000980	0.98	0.0386	
88860000610	0.61	0.0240	88860000990	0.99	0.0390	61
88860000620	0.62	0.0244	88860001000	1.00	0.0394	
88860000630	0.63	0.0248	88860001010	1.01	0.0398	60
88860000640	0.64	0.0252	88860001020	1.02	0.0402	
88860000650	0.65	0.0256	88860001030	1.03	0.0406	
88860000660	0.66	0.0260	88860001040	1.04	0.0409	59
88860000670	0.67	0.0264	88860001050	1.05	0.0413	
88860000680	0.68	0.0268	88860001060	1.06	0.0417	
88860000690	0.69	0.0272	88860001070	1.07	0.0421	58
88860000700	0.70	0.0276	88860001080	1.08	0.0425	
88860000710	0.71	0.0280	88860001090	1.09	0.0429	57
88860000720	0.72	0.0283	88860001100	1.10	0.0433	
88860000730	0.73	0.0287	88860001110	1.11	0.0437	
88860000740	0.74	0.0291	88860001120	1.12	0.0441	
88860000750	0.75	0.0295	88860001130	1.13	0.0445	
88860000760	0.76	0.0299	88860001140	1.14	0.0449	
88860000770	0.77	0.0303	88860001150	1.15	0.0453	
88860000780	0.78	0.0307	88860001160	1.16	0.0457	
88860000790	0.79	0.0311	88860001170	1.17	0.0461	
88860000800	0.80	0.0315	88860001180	1.18	0.0465	56
88860000810	0.81	0.0319	88860001190	1.19	0.0469	
88860000820	0.82	0.0323	88860001200	1.20	0.0472	
88860000830	0.83	0.0327	88860001210	1.21	0.0476	
88860000840	0.84	0.0331	88860001220	1.22	0.0480	
88860000850	0.85	0.0335	88860001230	1.23	0.0484	
88860000860	0.86	0.0339	88860001240	1.24	0.0488	
88860000870	0.87	0.0343	88860001250	1.25	0.0492	
88860000880	0.88	0.0346	88860001260	1.26	0.0496	
88860000890	0.89	0.0350	88860001270	1.27	0.0500	
88860000900	0.90	0.0354	88860001280	1.28	0.0504	
88860000910	0.91	0.0358	88860001290	1.29	0.0508	
88860000920	0.92	0.0362	88860001300	1.30	0.0512	
88860000930	0.93	0.0366	88860001310	1.31	0.0516	
88860000940	0.94	0.0370	88860001320	1.32	0.0520	55
88860000950	0.95	0.0374	88860001330	1.33	0.0524	
88860000960	0.96	0.0378	88860001340	1.34	0.0528	
88860000970	0.97	0.0382	88860001350	1.35	0.0531	

8600 Series			
EDP No.	(mm)	Decimal	Wire
88860001360	1.36	0.0535	
88860001370	1.37	0.0539	
88860001380	1.38	0.0543	
88860001390	1.39	0.0547	
88860001400	1.40	0.0551	54
88860001410	1.41	0.0555	
88860001420	1.42	0.0559	
88860001430	1.43	0.0563	
88860001440	1.44	0.0567	
88860001450	1.45	0.0571	
88860001460	1.46	0.0575	
88860001470	1.47	0.0579	
88860001480	1.48	0.0583	
88860001490	1.49	0.0587	
88860001500	1.50	0.0590	
88860001510	1.51	0.0594	53
88860001520	1.52	0.0598	
88860001530	1.53	0.0602	
88860001540	1.54	0.0606	
88860001550	1.55	0.0610	
88860001560	1.56	0.0614	
88860001570	1.57	0.0618	
88860001580	1.58	0.0622	
88860001590	1.59	0.0626	
88860001600	1.60	0.0630	
88860001610	1.61	0.0634	52
88860001620	1.62	0.0638	
88860001630	1.63	0.0642	
88860001640	1.64	0.0646	
88860001650	1.65	0.0650	
88860001660	1.66	0.0654	
88860001670	1.67	0.0657	
88860001680	1.68	0.0661	
88860001690	1.69	0.0665	
88860001700	1.70	0.0669	51
88860001710	1.71	0.0673	
88860001720	1.72	0.0677	
88860001730	1.73	0.0681	

10° left spiral/right hand cut for thru holes.

8600 Series			
EDP No.	(mm)	Decimal	Wire
88860001740	1.74	0.0685	
88860001750	1.75	0.0689	
88860001760	1.76	0.0693	
88860001770	1.77	0.0697	
88860001780	1.78	0.0701	50
88860001790	1.79	0.0705	
88860001800	1.80	0.0709	
88860001810	1.81	0.0713	
88860001820	1.82	0.0717	
88860001830	1.83	0.0720	
88860001840	1.84	0.0724	
88860001850	1.85	0.0728	49
88860001860	1.86	0.0732	
88860001870	1.87	0.0736	
88860001880	1.88	0.0740	
88860001890	1.89	0.0744	
88860001900	1.90	0.0748	
88860001910	1.91	0.0752	
88860001920	1.92	0.0756	
88860001930	1.93	0.0760	48
88860001940	1.94	0.0764	
88860001950	1.95	0.0768	
88860001960	1.96	0.0772	
88860001970	1.97	0.0776	
88860001980	1.98	0.0780	
88860001990	1.99	0.0783	47
88860002000	2.00	0.0787	
88860002010	2.01	0.0791	
88860002020	2.02	0.0795	
88860002030	2.03	0.0799	
88860002040	2.04	0.0803	
88860002050	2.05	0.0807	
88860002060	2.06	0.0811	46
88860002070	2.07	0.0815	
88860002080	2.08	0.0819	45
88860002090	2.09	0.0823	
88860002100	2.10	0.0827	
88860002110	2.11	0.0831	
88860002120	2.12	0.0835	
88860002130	2.13	0.0839	
88860002140	2.14	0.0843	
88860002150	2.15	0.0846	
88860002160	2.16	0.0850	
88860002170	2.17	0.0854	
88860002180	2.18	0.0858	44
88860002190	2.19	0.0862	
88860002200	2.20	0.0866	
88860002210	2.21	0.0870	
88860002220	2.22	0.0874	
88860002230	2.23	0.0878	
88860002240	2.24	0.0882	
88860002250	2.25	0.0886	
88860002260	2.26	0.0890	43
88860002270	2.27	0.0894	
88860002280	2.28	0.0898	
88860002290	2.29	0.0902	
88860002300	2.30	0.0906	
88860002310	2.31	0.0909	
88860002320	2.32	0.0913	
88860002330	2.33	0.0917	
88860002340	2.34	0.0921	
88860002350	2.35	0.0925	
88860002360	2.36	0.0929	
88860002370	2.37	0.0933	42
88860002380	2.38	0.0937	
88860002390	2.39	0.0941	

8600 Series			
EDP No.	(mm)	Decimal	Wire
88860002400	2.40	0.0945	
88860002410	2.41	0.0949	
88860002420	2.42	0.0953	
88860002430	2.43	0.0957	
88860002440	2.44	0.0961	41
88860002450	2.45	0.0965	
88860002460	2.46	0.0969	
88860002470	2.47	0.0972	
88860002480	2.48	0.0976	
88860002490	2.49	0.0980	40
88860002500	2.50	0.0984	
88860002510	2.51	0.0988	
88860002520	2.52	0.0992	
88860002530	2.53	0.0996	39
88860002540	2.54	0.1000	
88860002550	2.55	0.1004	
88860002560	2.56	0.1008	
88860002570	2.57	0.1012	
88860002580	2.58	0.1016	38
88860002590	2.59	0.1020	
88860002600	2.60	0.1024	
88860002610	2.61	0.1028	
88860002620	2.62	0.1031	
88860002630	2.63	0.1035	
88860002640	2.64	0.1039	37
88860002650	2.65	0.1043	
88860002660	2.66	0.1047	
88860002670	2.67	0.1051	
88860002680	2.68	0.1055	
88860002690	2.69	0.1059	
88860002700	2.70	0.1063	36
88860002710	2.71	0.1067	
88860002720	2.72	0.1071	
88860002730	2.73	0.1075	
88860002740	2.74	0.1079	
88860002750	2.75	0.1083	
88860002760	2.76	0.1087	
88860002770	2.77	0.1091	
88860002780	2.78	0.1094	
88860002790	2.79	0.1098	35
88860002800	2.80	0.1102	
88860002810	2.81	0.1106	
88860002820	2.82	0.1110	34
88860002830	2.83	0.1114	
88860002840	2.84	0.1118	
88860002850	2.85	0.1122	
88860002860	2.86	0.1126	
88860002870	2.87	0.1130	33
88860002880	2.88	0.1134	
88860002890	2.89	0.1138	
88860002900	2.90	0.1142	
88860002910	2.91	0.1146	
88860002920	2.92	0.1150	
88860002930	2.93	0.1154	
88860002940	2.94	0.1157	
88860002950	2.95	0.1161	32
88860002960	2.96	0.1164	
88860002970	2.97	0.1169	
88860002980	2.98	0.1173	
88860002990	2.99	0.1177	
88860003000	3.00	0.1181	
88860003010	3.01	0.1185	
88860003020	3.02	0.1189	
88860003030	3.03	0.1193	
88860003040	3.04	0.1197	
88860003050	3.05	0.1201	31

8600 Series			
EDP No.	(mm)	Decimal	Wire
88860003060	3.06	0.1205	
88860003070	3.07	0.1209	
88860003080	3.08	0.1213	
88860003090	3.09	0.1217	
88860003100	3.10	0.1220	
88860003110	3.11	0.1224	
88860003120	3.12	0.1228	
88860003130	3.13	0.1232	
88860003140	3.14	0.1236	
88860003150	3.15	0.1240	
88860003160	3.16	0.1244	
88860003170	3.17	0.1248	
88860003180	3.18	0.1252	
88860003190	3.19	0.1256	
88860003200	3.20	0.1260	
88860003210	3.21	0.1264	
88860003220	3.22	0.1268	
88860003230	3.23	0.1272	
88860003240	3.24	0.1276	
88860003250	3.25	0.1280	
88860003260	3.26	0.1283	30
88860003270	3.27	0.1287	
88860003280	3.28	0.1291	
88860003290	3.29	0.1295	
88860003300	3.30	0.1299	
88860003310	3.31	0.1303	
88860003320	3.32	0.1308	
88860003330	3.33	0.1311	
88860003340	3.34	0.1315	
88860003350	3.35	0.1319	
88860003360	3.36	0.1323	
88860003370	3.37	0.1327	
88860003380	3.38	0.1331	
88860003390	3.39	0.1335	
88860003400	3.40	0.1339	
88860003410	3.41	0.1343	
88860003420	3.42	0.1346	
88860003430	3.43	0.1350	
88860003440	3.44	0.1354	
88860003450	3.45	0.1358	29
88860003460	3.46	0.1362	
88860003470	3.47	0.1366	
88860003480	3.48	0.1370	
88860003490	3.49	0.1374	
88860003500	3.50	0.1378	
88860003510	3.51	0.1382	
88860003520	3.52	0.1386	
88860003530	3.53	0.1390	
88860003540	3.54	0.1394	
88860003550	3.55	0.1398	
88860003560	3.56	0.1402	
88860003570	3.57	0.1406	28
88860003580	3.58	0.1409	
88860003590	3.59	0.1413	
88860003600	3.60	0.1417	
88860003610	3.61	0.1421	
88860003620	3.62	0.1425	
88860003630	3.63	0.1429	
88860003640	3.64	0.1433	
88860003650	3.65	0.1437	
88860003660	3.66	0.1441	27
88860003670	3.67	0.1445	
88860003680	3.68	0.1449	
88860003690	3.69	0.1453	
88860003700	3.70	0.1457	

Note: Highlighted items are an increment of 0.0003

10° left spiral/right hand cut for thru holes.

8600 Series			
EDP No.	(mm)	Decimal	Wire
88860003710	3.71	0.1461	
88860003720	3.72	0.1465	
88860003730	3.73	0.1469	26
88860003740	3.74	0.1472	
88860003750	3.75	0.1476	
88860003760	3.76	0.1480	
88860003770	3.77	0.1484	
88860003780	3.78	0.1488	
88860003790	3.79	0.1492	
88860003800	3.80	0.1496	25
88860003810	3.81	0.1500	
88860003820	3.82	0.1504	
88860003830	3.83	0.1508	
88860003840	3.84	0.1512	
88860003850	3.85	0.1516	
88860003860	3.86	0.1520	24
88860003870	3.87	0.1524	
88860003880	3.88	0.1528	
88860003890	3.89	0.1531	
88860003900	3.90	0.1535	
88860003910	3.91	0.1539	23
88860003920	3.92	0.1543	
88860003930	3.93	0.1547	
88860003940	3.94	0.1551	
88860003950	3.95	0.1555	
88860003960	3.96	0.1559	
88860003970	3.97	0.1563	
88860003980	3.98	0.1567	
88860003990	3.99	0.1571	22
88860004000	4.00	0.1575	
88860004010	4.01	0.1579	
88860004020	4.02	0.1583	
88860004030	4.03	0.1587	
88860004040	4.04	0.1591	21
88860004050	4.05	0.1594	
88860004060	4.06	0.1598	
88860004070	4.07	0.1602	
88860004080	4.08	0.1606	
88860004090	4.09	0.1610	20
88860004100	4.10	0.1614	
88860004110	4.11	0.1618	
88860004120	4.12	0.1622	
88860004130	4.13	0.1626	
88860004140	4.14	0.1630	
88860004150	4.15	0.1634	
88860004160	4.16	0.1638	
88860004170	4.17	0.1642	
88860004180	4.18	0.1646	
88860004190	4.19	0.1650	
88860004200	4.20	0.1654	
88860004210	4.21	0.1657	
88860004220	4.22	0.1661	19
88860004230	4.23	0.1665	
88860004240	4.24	0.1669	
88860004250	4.25	0.1673	
88860004260	4.26	0.1677	
88860004270	4.27	0.1681	
88860004280	4.28	0.1685	
88860004290	4.29	0.1689	
88860004300	4.30	0.1693	18
88860004310	4.31	0.1697	
88860004320	4.32	0.1701	
88860004330	4.33	0.1705	
88860004340	4.34	0.1709	
88860004350	4.35	0.1713	
88860004360	4.36	0.1717	

8600 Series			
EDP No.	(mm)	Decimal	Wire
88860004370	4.37	0.1720	
88860004380	4.38	0.1724	
88860004390	4.39	0.1728	17
88860004400	4.40	0.1732	
88860004410	4.41	0.1736	
88860004420	4.42	0.1740	
88860004430	4.43	0.1744	
88860004440	4.44	0.1748	
88860004450	4.45	0.1752	
88860004460	4.46	0.1756	
88860004470	4.47	0.1760	
88860004480	4.48	0.1764	
88860004490	4.49	0.1768	16
88860004500	4.50	0.1772	
88860004510	4.51	0.1776	
88860004520	4.52	0.1780	
88860004530	4.53	0.1783	
88860004540	4.54	0.1787	
88860004550	4.55	0.1791	
88860004560	4.56	0.1795	
88860004570	4.57	0.1799	15
88860004580	4.58	0.1803	
88860004590	4.59	0.1807	
88860004600	4.60	0.1811	
88860004610	4.61	0.1815	
88860004620	4.62	0.1819	14
88860004630	4.63	0.1823	
88860004640	4.64	0.1827	
88860004650	4.65	0.1831	
88860004660	4.66	0.1835	
88860004670	4.67	0.1839	
88860004680	4.68	0.1843	
88860004690	4.69	0.1846	
88860004700	4.70	0.1850	13
88860004710	4.71	0.1854	
88860004720	4.72	0.1858	
88860004730	4.73	0.1862	
88860004740	4.74	0.1866	
88860004750	4.75	0.1870	
88860004760	4.76	0.1874	
88865004762	4.763	0.1875	
88860004770	4.77	0.1878	
88860004780	4.78	0.1882	
88860004790	4.79	0.1886	
88860004800	4.80	0.1890	12
88860004810	4.81	0.1894	
88860004820	4.82	0.1898	
88860004830	4.83	0.1902	
88860004840	4.84	0.1906	
88860004850	4.85	0.1909	11
88860004860	4.86	0.1913	
88860004870	4.87	0.1917	
88860004880	4.88	0.1921	
88860004890	4.89	0.1925	
88860004900	4.90	0.1929	
88860004910	4.91	0.1933	10
88860004920	4.92	0.1937	
88860004930	4.93	0.1941	
88860004940	4.94	0.1945	
88860004950	4.95	0.1949	
88860004960	4.96	0.1953	
88860004970	4.97	0.1957	
88860004980	4.98	0.1961	9
88860004990	4.99	0.1965	
88860005000	5.00	0.1969	
88860005010	5.01	0.1972	

8600 Series			
EDP No.	(mm)	Decimal	Wire
88860005020	5.02	0.1976	
88860005030	5.03	0.1980	
88860005040	5.04	0.1984	
88860005050	5.05	0.1988	8
88860005060	5.06	0.1992	
88860005070	5.07	0.1996	
88860005080	5.08	0.2000	
88860005090	5.09	0.2004	
88860005100	5.10	0.2008	7
88860005110	5.11	0.2012	
88860005120	5.12	0.2016	
88860005130	5.13	0.2020	
88860005140	5.14	0.2024	
88860005150	5.15	0.2028	
88860005160	5.16	0.2031	
88860005170	5.17	0.2035	
88860005180	5.18	0.2039	6
88860005190	5.19	0.2043	
88860005200	5.20	0.2047	
88860005210	5.21	0.2051	
88860005220	5.22	0.2055	5
88860005230	5.23	0.2059	
88860005240	5.24	0.2063	
88860005250	5.25	0.2067	
88860005260	5.26	0.2071	
88860005270	5.27	0.2075	
88860005280	5.28	0.2079	
88860005290	5.29	0.2083	
88860005300	5.30	0.2087	
88860005310	5.31	0.2091	4
88860005320	5.32	0.2094	
88860005330	5.33	0.2098	
88860005340	5.34	0.2102	
88860005350	5.35	0.2106	
88860005360	5.36	0.2110	
88860005370	5.37	0.2114	
88860005380	5.38	0.2118	
88860005390	5.39	0.2122	
88860005400	5.40	0.2126	
88860005410	5.41	0.2130	3
88860005420	5.42	0.2134	
88860005430	5.43	0.2138	
88860005440	5.44	0.2142	
88860005450	5.45	0.2146	
88860005460	5.46	0.2150	
88860005470	5.47	0.2154	
88860005480	5.48	0.2158	
88860005490	5.49	0.2161	
88860005500	5.50	0.2165	
88860005510	5.51	0.2169	
88860005520	5.52	0.2173	
88860005530	5.53	0.2177	
88860005540	5.54	0.2181	
88860005550	5.55	0.2185	
88860005560	5.56	0.2189	
88860005570	5.57	0.2193	
88860005580	5.58	0.2197	
88860005590	5.59	0.2201	
88860005600	5.60	0.2205	
88860005610	5.61	0.2209	2
88860005620	5.62	0.2213	
88860005630	5.63	0.2217	
88860005640	5.64	0.2220	
88860005650	5.65	0.2224	
88860005660	5.66	0.2228	
88860005670	5.67	0.2232	

Note: Highlighted items are an increment of 0.0003

10° left spiral/right hand cut for thru holes.

8600 Series			
EDP No.	(mm)	Decimal	Wire
88860005680	5.68	0.2236	
88860005690	5.69	0.2240	
88860005700	5.70	0.2244	
88860005710	5.71	0.2248	
88860005720	5.72	0.2252	
88860005730	5.73	0.2256	
88860005740	5.74	0.2260	
88860005750	5.75	0.2264	
88860005760	5.76	0.2268	
88860005770	5.77	0.2272	
88860005780	5.78	0.2276	
88860005790	5.79	0.2280	1
88860005800	5.80	0.2284	
88860005810	5.81	0.2288	
88860005820	5.82	0.2291	
88860005830	5.83	0.2295	
88860005840	5.84	0.2299	
88860005850	5.85	0.2303	
88860005860	5.86	0.2307	
88860005870	5.87	0.2311	
88860005880	5.88	0.2315	
88860005890	5.89	0.2319	
88860005900	5.90	0.2323	
88860005910	5.91	0.2327	
88860005920	5.92	0.2331	
88860005930	5.93	0.2335	
88860005940	5.94	0.2339	A
88860005950	5.95	0.2343	
88860005960	5.96	0.2347	
88860005970	5.97	0.2350	
88860005980	5.98	0.2354	
88860005990	5.99	0.2358	
88860006000	6.00	0.2362	
88860006010	6.01	0.2366	
88860006020	6.02	0.2370	
88860006030	6.03	0.2374	
88860006040	6.04	0.2378	
88860006050	6.05	0.2382	B
88860006060	6.06	0.2386	
88860006070	6.07	0.2390	
88860006080	6.08	0.2394	
88860006090	6.09	0.2398	
88860006100	6.10	0.2402	
88860006110	6.11	0.2406	
88860006120	6.12	0.2410	
88860006130	6.13	0.2413	
88860006140	6.14	0.2417	
88860006150	6.15	0.2421	C
88860006160	6.16	0.2425	
88860006170	6.17	0.2429	
88860006180	6.18	0.2433	
88860006190	6.19	0.2437	
88860006200	6.20	0.2441	
88860006210	6.21	0.2445	
88860006220	6.22	0.2449	
88860006230	6.23	0.2453	
88860006240	6.24	0.2457	
88860006250	6.25	0.2461	D
88860006260	6.26	0.2465	
88860006270	6.27	0.2468	
88860006280	6.28	0.2472	
88860006290	6.29	0.2476	
88860006300	6.30	0.2480	
88860006310	6.31	0.2484	
88860006320	6.32	0.2488	
88860006330	6.33	0.2492	

8600 Series			
EDP No.	(mm)	Decimal	Wire
88860006340	6.34	0.2496	
88860006350	6.35	0.2500	E
88860006360	6.36	0.2504	
88860006370	6.37	0.2508	
88860006380	6.38	0.2512	
88860006390	6.39	0.2517	
88860006400	6.40	0.2520	
88860006410	6.41	0.2524	
88860006420	6.42	0.2528	
88860006430	6.43	0.2531	
88860006440	6.44	0.2535	
88860006450	6.45	0.2539	
88860006460	6.46	0.2543	
88860006470	6.47	0.2547	
88860006480	6.48	0.2551	
88860006490	6.49	0.2555	
88860006500	6.50	0.2559	
88860006510	6.51	0.2563	
88860006520	6.52	0.2567	
88860006530	6.53	0.2571	F
88860006540	6.54	0.2575	
88860006550	6.55	0.2579	
88860006560	6.56	0.2583	
88860006570	6.57	0.2587	
88860006580	6.58	0.2591	
88860006590	6.59	0.2594	
88860006600	6.60	0.2598	
88860006610	6.61	0.2602	
88860006620	6.62	0.2606	
88860006630	6.63	0.2610	G
88860006640	6.64	0.2614	
88860006650	6.65	0.2618	
88860006660	6.66	0.2622	
88860006670	6.67	0.2626	
88860006680	6.68	0.2630	
88860006690	6.69	0.2634	
88860006700	6.70	0.2638	
88860006710	6.71	0.2642	
88860006720	6.72	0.2646	
88860006730	6.73	0.2650	
88860006740	6.74	0.2654	
88860006750	6.75	0.2657	
88860006760	6.76	0.2661	H
88860006770	6.77	0.2665	
88860006780	6.78	0.2669	
88860006790	6.79	0.2673	
88860006800	6.80	0.2677	
88860006810	6.81	0.2681	
88860006820	6.82	0.2685	
88860006830	6.83	0.2689	
88860006840	6.84	0.2693	
88860006850	6.85	0.2697	
88860006860	6.86	0.2701	
88860006870	6.87	0.2705	
88860006880	6.88	0.2709	
88860006890	6.89	0.2713	
88860006900	6.90	0.2717	
88860006910	6.91	0.2720	I
88860006920	6.92	0.2724	
88860006930	6.93	0.2728	
88860006940	6.94	0.2732	
88860006950	6.95	0.2736	
88860006960	6.96	0.2740	
88860006970	6.97	0.2744	
88860006980	6.98	0.2748	
88860006990	6.99	0.2752	

8600 Series			
EDP No.	(mm)	Decimal	Wire
88860007000	7.00	0.2756	
88860007010	7.01	0.2760	
88860007020	7.02	0.2764	
88860007030	7.03	0.2768	J
88860007040	7.04	0.2772	
88860007050	7.05	0.2776	
88860007060	7.06	0.2780	
88860007070	7.07	0.2783	
88860007080	7.08	0.2787	
88860007090	7.09	0.2791	
88860007100	7.10	0.2795	
88860007110	7.11	0.2799	
88860007120	7.12	0.2803	
88860007130	7.13	0.2807	
88860007140	7.14	0.2811	K
88860007150	7.15	0.2815	
88860007160	7.16	0.2819	
88860007170	7.17	0.8223	
88860007180	7.18	0.2827	
88860007190	7.19	0.2831	
88860007200	7.20	0.2835	
88860007210	7.21	0.2839	
88860007220	7.22	0.2843	
88860007230	7.23	0.2846	
88860007240	7.24	0.2850	
88860007250	7.25	0.2854	
88860007260	7.26	0.2858	
88860007270	7.27	0.2862	
88860007280	7.28	0.2866	
88860007290	7.29	0.2870	
88860007300	7.30	0.2874	
88860007310	7.31	0.2878	
88860007320	7.32	0.2882	
88860007330	7.33	0.2886	
88860007340	7.34	0.2890	
88860007350	7.35	0.2894	
88860007360	7.36	0.2898	L
88860007370	7.37	0.2902	
88860007380	7.38	0.2906	
88860007390	7.39	0.2909	
88860007400	7.40	0.2913	
88860007410	7.41	0.2917	
88860007420	7.42	0.2921	
88860007430	7.43	0.2925	
88860007440	7.44	0.2929	
88860007450	7.45	0.2933	
88860007460	7.46	0.2937	
88860007470	7.47	0.2941	
88860007480	7.48	0.2945	
88860007490	7.49	0.2949	M
88860007500	7.50	0.2953	
88860007510	7.51	0.2957	
88860007520	7.52	0.2961	
88860007530	7.53	0.2965	
88860007540	7.54	0.2969	
88860007550	7.55	0.2972	
88860007560	7.56	0.2976	
88860007570	7.57	0.2980	
88860007580	7.58	0.2984	
88860007590	7.59	0.2988	
88860007600	7.60	0.2992	
88860007610	7.61	0.2996	
88860007620	7.62	0.3000	
88860007630	7.63	0.3004	
88860007640	7.64	0.3008	
88860007650	7.65	0.3012	

Note: Highlighted items are an increment of 0.0003

10° left spiral/right hand cut for thru holes.

8600 Series			
EDP No.	(mm)	Decimal	Wire
88860007660	7.66	0.3016	
88860007670	7.67	0.3020	N
88860007680	7.68	0.3024	
88860007690	7.69	0.3028	
88860007700	7.70	0.3031	
88860007710	7.71	0.3035	
88860007720	7.72	0.3039	
88860007730	7.73	0.3043	
88860007740	7.74	0.3047	
88860007750	7.75	0.3051	
88860007760	7.76	0.3055	
88860007770	7.77	0.3059	
88860007780	7.78	0.3063	
88860007790	7.79	0.3067	
88860007800	7.80	0.3071	
88860007810	7.81	0.3075	
88860007820	7.82	0.3079	
88860007830	7.83	0.3083	
88860007840	7.84	0.3087	
88860007850	7.85	0.3091	
88860007860	7.86	0.3094	
88860007870	7.87	0.3098	
88860007880	7.88	0.3102	
88860007890	7.89	0.3106	
88860007900	7.90	0.3110	
88860007910	7.91	0.3114	
88860007920	7.92	0.3118	
88860007930	7.93	0.3122	
88865007937	7.938	0.3125	
88860007940	7.94	0.3126	
88860007950	7.95	0.3130	
88860007960	7.96	0.3134	
88860007970	7.97	0.3138	
88860007980	7.98	0.3142	
88860007990	7.99	0.3146	
88860008000	8.00	0.3150	
88860008010	8.01	0.3154	
88860008020	8.02	0.3157	
88860008030	8.03	0.3161	O
88860008040	8.04	0.3165	
88860008050	8.05	0.3169	
88860008060	8.06	0.3173	
88860008070	8.07	0.3177	
88860008080	8.08	0.3181	
88860008090	8.09	0.3185	
88860008100	8.10	0.3189	
88860008110	8.11	0.3193	
88860008120	8.12	0.3197	
88860008130	8.13	0.3201	
88860008140	8.14	0.3205	
88860008150	8.15	0.3209	
88860008160	8.16	0.3213	
88860008170	8.17	0.3217	
88860008180	8.18	0.3220	
88860008190	8.19	0.3224	
88860008200	8.20	0.3228	P
88860008210	8.21	0.3232	
88860008220	8.22	0.3236	
88860008230	8.23	0.3240	
88860008240	8.24	0.3244	
88860008250	8.25	0.3248	
88860008260	8.26	0.3252	
88860008270	8.27	0.3256	
88860008280	8.28	0.3260	
88860008290	8.29	0.3264	

8600 Series			
EDP No.	(mm)	Decimal	Wire
88860008300	8.30	0.3268	
88860008310	8.31	0.3272	
88860008320	8.32	0.3276	
88860008330	8.33	0.3280	
88860008340	8.34	0.3283	
88860008350	8.35	0.3287	
88860008360	8.36	0.3291	
88860008370	8.37	0.3295	
88860008380	8.38	0.3299	
88860008390	8.39	0.3303	
88860008400	8.40	0.3307	
88860008410	8.41	0.3311	
88860008420	8.42	0.3315	
88860008430	8.43	0.3319	Q
88860008440	8.44	0.3323	
88860008450	8.45	0.3327	
88860008460	8.46	0.3331	
88860008470	8.47	0.3335	
88860008480	8.48	0.3339	
88860008490	8.49	0.3343	
88860008500	8.50	0.3346	
88860008510	8.51	0.3350	
88860008520	8.52	0.3354	
88860008530	8.53	0.3358	
88860008540	8.54	0.3362	
88860008550	8.55	0.3366	
88860008560	8.56	0.3370	
88860008570	8.57	0.3374	
88860008580	8.58	0.3378	
88860008590	8.59	0.3382	
88860008600	8.60	0.3386	
88860008610	8.61	0.3390	R
88860008620	8.62	0.3394	
88860008630	8.63	0.3398	
88860008640	8.64	0.3402	
88860008650	8.65	0.3406	
88860008660	8.66	0.3409	
88860008670	8.67	0.3413	
88860008680	8.68	0.3417	
88860008690	8.69	0.3421	
88860008700	8.70	0.3425	
88860008710	8.71	0.3429	
88860008720	8.72	0.3433	
88860008730	8.73	0.3437	
88860008740	8.74	0.3441	
88860008750	8.75	0.3445	
88860008760	8.76	0.3449	
88860008770	8.77	0.3453	
88860008780	8.78	0.3457	
88860008790	8.79	0.3461	
88860008800	8.80	0.3465	
88860008810	8.81	0.3469	
88860008820	8.82	0.3472	
88860008830	8.83	0.3476	
88860008840	8.84	0.3480	S
88860008850	8.85	0.3484	
88860008860	8.86	0.3488	
88860008870	8.87	0.3492	
88860008880	8.88	0.3496	
88860008890	8.89	0.3500	
88860008900	8.90	0.3504	
88860008910	8.91	0.3508	
88860008920	8.92	0.3512	
88860008930	8.93	0.3516	
88860008940	8.94	0.3520	

8600 Series			
EDP No.	(mm)	Decimal	Wire
88860008950	8.95	0.3524	
88860008960	8.96	0.3528	
88860008970	8.97	0.3531	
88860008980	8.98	0.3535	
88860008990	8.99	0.3539	
88860009000	9.00	0.3543	
88860009010	9.01	0.3547	
88860009020	9.02	0.3551	
88860009030	9.03	0.3555	
88860009040	9.04	0.3559	
88860009050	9.05	0.3563	
88860009060	9.06	0.3567	
88860009070	9.07	0.3571	
88860009080	9.08	0.3575	
88860009090	9.09	0.3579	T
88860009100	9.10	0.3583	
88860009110	9.11	0.3587	
88860009120	9.12	0.3591	
88860009130	9.13	0.3594	
88860009140	9.14	0.3598	
88860009150	9.15	0.3602	
88860009170	9.17	0.3610	
88860009180	9.18	0.3614	
88860009190	9.19	0.3618	
88860009200	9.20	0.3622	
88860009210	9.21	0.3626	
88860009220	9.22	0.3630	
88860009230	9.23	0.3634	
88860009240	9.24	0.3638	
88860009250	9.25	0.3642	
88860009260	9.26	0.3646	
88860009270	9.27	0.3650	
88860009280	9.28	0.3654	
88860009290	9.29	0.3657	
88860009300	9.30	0.3661	
88860009310	9.31	0.3665	
88860009320	9.32	0.3669	
88860009330	9.33	0.3673	
88860009340	9.34	0.3677	
88860009350	9.35	0.3681	U
88860009360	9.36	0.3685	
88860009370	9.37	0.3689	
88860009380	9.38	0.3693	
88860009390	9.39	0.3697	
88860009400	9.40	0.3701	
88860009410	9.41	0.3705	
88860009420	9.42	0.3709	
88860009430	9.43	0.3713	
88860009440	9.44	0.3717	
88860009450	9.45	0.3720	
88860009460	9.46	0.3724	
88860009470	9.47	0.3728	
88860009480	9.48	0.3732	
88860009490	9.49	0.3736	
88860009500	9.50	0.3740	
88860009510	9.51	0.3744	
88860009520	9.52	0.3748	
88865009525	9.525	0.3750	
88860009530	9.53	0.3752	
88860009540	9.54	0.3756	
88860009550	9.55	0.3760	
88860009560	9.56	0.3763	
88860009570	9.57	0.3767	
88860009650	9.65	-	
88860009730	9.73	-	

Note: Highlighted items are an increment of 0.0003

10° left spiral/right hand cut for thru holes.

8600 Series		
25/64" Range		
EDP No.	(mm)	Decimal
88860009870	9.87	0.3886
88860009880	9.88	0.3889
88860009890	9.89	0.3893
88860009900	9.90	0.3897
88860009910	9.91	0.3901
88860009920	9.92	0.3905
88860009930	9.93	0.3909
88860009940	9.94	0.3913
88860009950	9.95	0.3917
88860009960	9.96	0.3921
10mm Range		
EDP No.	(mm)	Decimal
88860009970	9.97	0.3925
88860009980	9.98	0.3929
88860009990	9.99	0.3933
88860010000	10.00	0.3937
88860010010	10.01	0.3941
88860010020	10.02	0.3945
88860010030	10.03	0.3949
88860010040	10.04	0.3953
88860010050	10.05	0.3957
27/64" Range		
EDP No.	(mm)	Decimal
88860010660	10.66	0.4197
88860010670	10.67	0.4201
88860010680	10.68	0.4205
88860010690	10.69	0.4209
88860010700	10.70	0.4213
88860010710	10.71	0.4217
88860010720	10.72	0.4220
88860010730	10.73	0.4224
88860010740	10.74	0.4228
88860010750	10.75	0.4232
88860010760	10.76	0.4236
11mm Range		
EDP No.	(mm)	Decimal
88860010950	10.95	0.4311
88860010960	10.96	0.4315
88860010970	10.97	0.4319
88860010980	10.98	0.4323
88860010990	10.99	0.4327
88860011000	11.00	0.4331
88860011010	11.01	0.4335
88860011020	11.02	0.4339
88860011030	11.03	0.4343
88860011040	11.04	0.4346
88860011050	11.05	0.4350
7/16" Range		
EDP No.	(mm)	Decimal
88860011060	11.06	0.4354
88860011070	11.07	0.4358
88860011080	11.08	0.4362
88860011090	11.09	0.4366
88860011100	11.10	0.4370
88860011110	11.11	0.4374
88865011112	11.113	0.4375
88860011120	11.12	0.4378
88860011130	11.13	0.4382
88860011140	11.14	0.4386
88860011150	11.15	0.4390
88860011160	11.16	0.4394
88860011170	11.17	-

8600 Series		
29/64" & 11.5mm Range		
EDP No.	(mm)	Decimal
88860011450	11.45	0.4508
88860011460	11.46	0.4512
88860011470	11.47	0.4516
88860011480	11.48	0.4520
88860011490	11.49	0.4524
88860011500	11.50	0.4528
88860011510	11.51	0.4531
88860011520	11.52	0.4535
88860011530	11.53	0.4539
88860011540	11.54	0.4543
88860011550	11.55	0.4547
5/32" Range		
EDP No.	(mm)	Decimal
88860011850	11.85	0.4665
88860011860	11.86	0.4669
88860011870	11.87	0.4673
88860011880	11.88	0.4677
88860011890	11.89	0.4681
88860011900	11.90	0.4685
88860011910	11.91	0.4689
88860011920	11.92	0.4693
88860011930	11.93	0.4697
12mm Range		
EDP No.	(mm)	Decimal
88860011940	11.94	0.4701
88860011950	11.95	0.4705
88860011960	11.96	0.4709
88860011970	11.97	0.4713
88860011980	11.98	0.4717
88860011990	11.99	0.4720
88860012000	12.00	0.4724
88860012010	12.01	0.4728
88860012020	12.02	0.4732
88860012030	12.03	0.4736
88860012040	12.04	0.4740
88860012050	12.05	0.4744
31/64" Range		
EDP No.	(mm)	Decimal
88860012250	12.25	0.4823
88860012260	12.26	0.4827
88860012270	12.27	0.4831
88860012280	12.28	0.4835
88860012290	12.29	0.4839
88860012300	12.30	0.4843
88860012310	12.31	0.4846
88860012320	12.32	0.4850
88860012330	12.33	0.4854
88860012340	12.34	0.4858
88860012350	12.35	0.4862

8600 Series		
1/2" Range		
EDP No.	(mm)	Decimal
88860012650	12.65	0.4980
88860012660	12.66	0.4984
88860012670	12.67	0.4988
88860012680	12.68	0.4992
88860012690	12.69	0.4996
88860012700	12.70	0.5000
88860012710	12.71	0.5004
88860012720	12.72	0.5008
88860012730	12.73	0.5012
88860012740	12.74	0.5016
88860012750	12.75	0.5020
88860012940	12.94	0.5094
88860012950	12.95	0.5098
88860012960	12.96	0.5102
88860012970	12.97	0.5106
88860012980	12.98	0.5110
88860012990	12.99	0.5114
13mm Range		
EDP No.	(mm)	Decimal
88860013000	13.00	0.5118
88860013010	13.01	0.5122
88860013020	13.02	0.5126
88860013030	13.03	0.5130
88860013040	13.04	0.5134
88860013050	13.05	0.5138
88865014287	14.287	0.5625
88865015875	15.875	0.6250
88865019050	19.050	0.7500

Note: Highlighted items are an increment of 0.0003

Reamer Formulas for Speeds & Feeds

The parameters below are based on using a carbide reamer at the highest SFM

SFM: Surface Feet per Minute
RPM: Revolutions per Minute
IPT: Inches per Tooth (chip load)
IPM: Inches per Minute
IPR: Inches per Revolution

Speed Formula:
RPM = 3.82 x (SFM ÷ Diameter)
Feed:
IPM = IPT x # of Flutes x RPM
IPR = IPM ÷ RPM
SFM = RPM x Diameter ÷ 3.82

Example:
 using a Carbide 2mm Reamer
 in Steel < 81 HRB
RPM = 3.82 x (132 ÷ .0787) = 6407 RPM
IPM = .0015 x 4 x 6407 = 38.4 IPM
IPR = 38.4 ÷ 6407 = .0059 IPR

This chart lists general reference parameters for a starting point. Below are a couple of tips for fine-tuning the desired size.

To increase the hole diameter: Slow down the feed rate and/or decrease RPM

To decrease the hole diameter: Increase the feed rate and/or increase the RPM

General reference parameters for a starting point									
Material	Speed / SFM			Diameter mm					
	Carbide	Cobalt		2	4	6	10	15	20
Steel < 81 HRB	82 – 132	49 – 72	IPR	0.006	0.006	0.006	0.0098	0.0098	0.0118
			IPM	38.4	19.2	12.8	12.3	8.2	7.7
			RPM	6400	3200	2130	1300	850	640
Steel < 24 Rc.	66 – 82	39 – 56	IPR	0.0039	0.0039	0.0047	0.0071	0.0071	0.0098
			IPM	14.3	8.4	6.4	5.7	3.8	3.8
			RPM	4000	2000	1300	800	500	400
Steel 24-32 Rc.	39 – 59	25 – 33	IPR	0.0031	0.0031	0.0039	0.0071	0.0059	0.0087
			IPM	8.6	4.3	3.4	4.1	2.3	2.4
			RPM	2800	1430	1000	600	400	280
Steel 32-41 Rc.	33 – 49	16 – 23	IPR	0.0031	0.0031	0.0035	0.0059	0.0079	0.0098
			IPM	7.1	3.6	2.9	2.9	2.5	2.3
			RPM	2400	1200	800	500	300	240
Stainless Steel	23 – 39	10 – 16	IPR	0.0028	0.0028	0.0039	0.0047	0.0059	0.0079
			IPM	5.7	2.8	2.3	1.8	1.5	1.5
			RPM	1900	950	630	400	250	240
Inconel/Waspaloy	20 – 33	7 – 10	IPR	0.0028	0.0028	0.0039	0.0047	0.0059	0.0079
			IPM	4.8	2.4	1.9	1.5	1.3	1.2
			RPM	1600	800	540	320	200	200
Cast Iron ≤ 180 HB (Grey)	99 – 132	20 – 49	IPR	0.0039	0.0039	0.0047	0.0079	0.0098	0.0098
			IPM	231.1	11.5	10.2	10	8.2	6.1
			RPM	6400	3200	2130	1300	850	640
Cast Iron > 180 HB	26 – 49	13 – 16	IPR	0.0028	0.0028	0.0039	0.0059	0.0071	0.0079
			IPM	7.1	3.6	2.9	2.9	2.3	1.9
			RPM	2400	1200	800	480	300	240
Copper	82 – 99	39 – 66	IPR	0.0047	0.0047	0.0071	0.0079	0.0098	0.0118
			IPM	23.1	11.5	11.5	7.5	6.1	5.8
			RPM	4800	2400	1600	960	640	480
Brass	115 – 132	66 – 99	IPR	0.0079	0.0079	0.0087	0.0118	0.0138	0.0157
			IPM	50	25	17.9	15.4	11.8	10
			RPM	6400	3200	2130	1300	850	640
Bronze	66 – 82	39 – 56	IPR	0.0059	0.0059	0.0071	0.0087	0.138	0.0146
			IPM	21.5	11.9	9.5	7.2	7.3	5.7
			RPM	4000	2000	1320	800	530	400
Aluminum	132 – 197	82 – 115	IPR	0.0059	0.0059	0.0071	0.0098	0.0118	0.0138
			IPM	57.3	28.7	22.9	18.3	15.3	13.2
			RPM	9500	4800	3200	1900	1300	950
Recommended drill hole diameter:				1.90	3.90	5.85	9.80	14.70	19.70

Note: Reference pg. 118 for Drill Hole Diameter Chart

Reamer Hole Size Chart

Correct Hole Sizes for Best Reamer Results

All Magafor Micro and Miniature Solid Carbide Reamers are left-hand spiral/right-hand cut with a 45° Lead. Designed for thru holes or holes with enough room to accommodate a small amount of waste material.

The left-hand spiral acts like an Archimedean Screw. Coolant is directly led to the cutting edges for better lubrication and cooling. Chips are pushed forward with no scratches and leave outstanding surface finishes.

Over 1,125 Standard Sizes

Starting at .0079 in .0002" increments to 0.0236"
In 0.0004" increments to 0.5020"

Final Hole Size to Drilled Hole Size		
Final Hole Reamer Size (mm/inch)	Reduce Drill Hole Size (inch) min/max	Reduce Drill Hole Size (mm) min/max
0.20 / 0.00787	-0.00157 / -0.00236	-0.04 / -0.06
0.30 / 0.01181	-0.00197 / -0.00315	-0.05 / -0.08
0.40 / 0.01575	-0.00197 / -0.00394	-0.05 / -0.10
0.50 / 0.01969	-0.00197 / -0.0047	-0.05 / -0.12
0.60 / 0.02362	-0.0019 / -0.00472	-0.05 / -0.12
2.00 / 0.07874	-0.00197 / -0.00472	-0.05 / -0.12
6.00 / 0.23622	-0.00591 / -0.00787	-0.15 / -0.20
10.00 / 0.39370	-0.0059 / -0.00787	-0.15 / -0.20
15.00 / 0.59055	-0.01181 / -0.01575	-0.30 / -0.40
20.00 / 0.78740	-0.01181 / -0.01575	-0.30 / -0.40
25.00 / 0.98425	-0.01181 / -0.01969	-0.30 / -0.50
15.00 / 0.59055	-0.01181 / -0.01575	-0.30 / -0.40
20.00 / 0.78740	-0.01181 / -0.01575	-0.30 / -0.40
25.00 / 0.98425	-0.01181 / -0.01969	-0.30 / -0.50

220° Ball-End Miniature End-Mills with Back Clearance

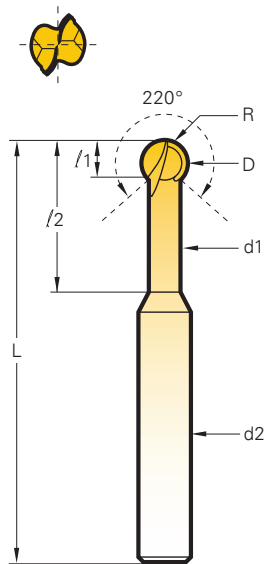
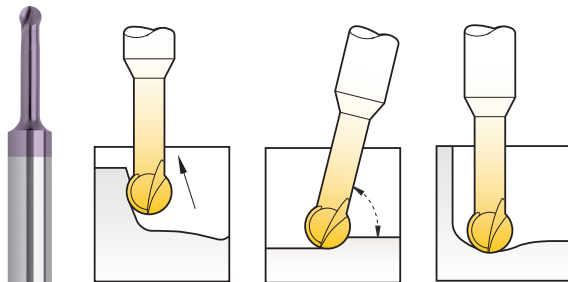

Metric Long Neck Series								/ 2
= 5 x D								
Diameter		d1	d2	L	/ 1	/ 2	R	Hard'X
(inch)	(mm)							8522-H
0.0315	0.8	0.70	3	60	0.55	4.0	0.4	888522H0080
0.0394	1.0	0.85	3	60	0.70	5.0	0.5	888522H0100
0.0472	1.2	1.00	3	60	0.80	6.0	0.6	888522H0120
0.0590	1.5	1.30	3	60	1.00	7.5	0.75	888522H0150
0.0787	2.0	1.70	3	60	1.35	10.0	1.0	888522H0200
0.1180	3.0	2.60	6	75	2.00	15.0	1.5	888522H0300
0.1575	4.0	3.45	6	75	2.70	20.0	2.0	888522H0400
0.1969	5.0	4.30	6	75	3.40	25.0	2.5	888522H0500

K15 Carbide

High Performance Micro-Milling

Applications: **Machining hard materials, abrasives composites, titanium and Hi-temp Alloys.**

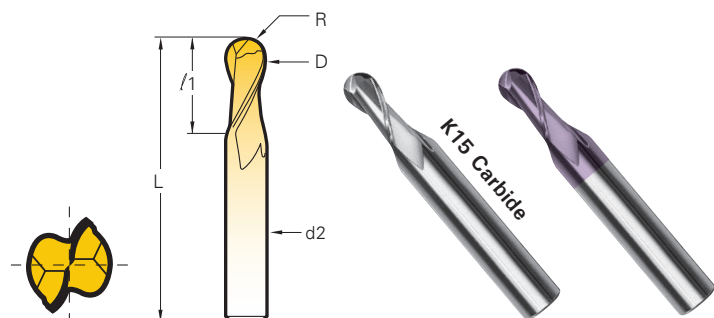

Ball End Series		L = 39mm		d2 = 0.188 / 3mm		l1 = 1.5 x D	
Diameter		l1	r	magafor		Hard'X	
(inch)	(mm)			8527	8527-H		
0.0039	0.10	0.0039	0.0020	88852700100	-	-	-
0.0059	0.15	0.0079	0.0030	88852700150	-	-	-
0.0079	0.20	0.0118	0.0039	88852700200	-	-	-
0.0098	0.25	0.0138	0.0049	88852700250	-	-	-
0.0118	0.30	0.0177	0.0059	88852700300	888527H0030	-	-
0.0157	0.40	0.0236	0.0079	88852700400	888527H0040	-	-
0.0197	0.50	0.0295	0.0098	88852700500	888527H0050	-	-
0.0236	0.60	0.0354	0.0118	88852700600	888527H0060	-	-
0.0276	0.70	0.0413	0.0138	88852700700	888527H0070	-	-
0.0315	0.80	0.0472	0.0157	88852700800	888527H0080	-	-
0.0354	0.90	0.0531	0.0177	88852700900	888527H0090	-	-
0.0394	1.00	0.0591	0.0197	88852701000	888527H0100	-	-
0.0472	1.20	0.0709	0.0236	88852701200	888527H0120	-	-
0.0591	1.50	0.0886	0.0295	88852701500	888527H0150	-	-
0.0787	2.00	0.1181	0.0394	88852702000	888527H0200	-	-

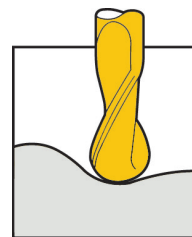

Copying

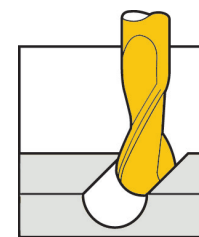

Precise Grooving
0 - 0.01mm

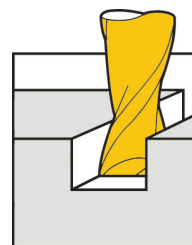

Precise Grooving
R +/- 0.01mm

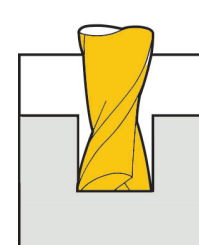

Flat Bottom Boring

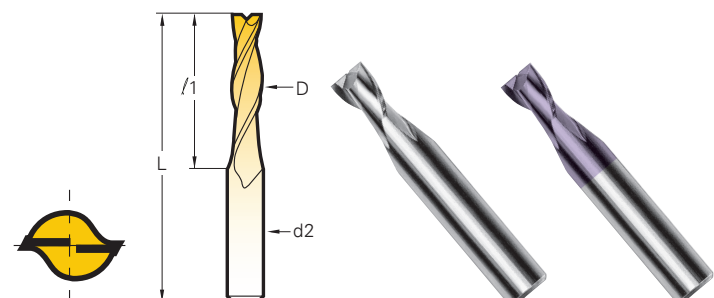

Square End Series		L = 39mm		d2 = 3mm		l1 = 1.5 x D	
Diameter		l1	r	magafor		Hard'X	
(inch)	(mm)			8507	8507-H		
0.0039	0.10	0.0039	0.0020	88850700100	-	-	-
0.0059	0.15	0.0079	0.0030	88850700150	-	-	-
0.0079	0.20	0.0118	0.0039	88850700200	-	-	-
0.0098	0.25	0.0138	0.0049	88850700250	-	-	-
0.0118	0.30	0.0177	0.0059	88850700300	888507H0030	-	-
0.0157	0.40	0.0236	0.0079	88850700400	888507H0040	-	-
0.0197	0.50	0.0295	0.0098	88850700500	888507H0050	-	-
0.0236	0.60	0.0354	0.0118	88850700600	888507H0060	-	-
0.0276	0.70	0.0413	0.0138	88850700700	888507H0070	-	-
0.0315	0.80	0.0472	0.0157	88850700800	888507H0080	-	-
0.0354	0.90	0.0531	0.0177	88850700900	888507H0090	-	-
0.0394	1.00	0.0591	0.0197	88850701000	888507H0100	-	-
0.0433	1.10	0.0650	0.0217	88850701100	888507H0110	-	-
0.0472	1.20	0.0709	0.0236	88850701200	888507H0120	-	-
0.0512	1.30	0.0768	0.0256	88850701300	888507H0130	-	-
0.0551	1.40	0.0827	0.0275	88850701400	888507H0140	-	-
0.0591	1.50	0.0886	0.0295	88850701500	888507H0150	-	-
0.0630	1.60	0.0945	0.0314	88850701600	888507H0160	-	-
0.0669	1.70	0.1004	0.0333	88850701700	888507H0170	-	-
0.0709	1.80	0.1063	0.0352	88850701800	888507H0180	-	-
0.0748	1.90	0.1122	0.0371	88850701900	888507H0190	-	-
0.0787	2.00	0.1181	0.0390	88850702000	888507H0200	-	-

Engaged right from the start in the process aspiring to excellence, in addition to our Futura and TiN coatings, Magafor offers three "X" coatings, sprung from multi-layer nano technology.

Hard'X [For hard milling] carbide tool coating has a high hardness (3500 HV) and shows a high thermic stability. It offers excellent protection against heat and wear and is ideal for dry machining-high speed cut-in treated steels and dies up to 67 Rc.

Graph'X [For composite milling] diamond coating (8000 HV) is particularly effective when machining graphite, composite materials, plastics with glass-fibers or carbon-fibers.

Standard Length Miniature End-mills

Standard Length Miniature End-Mills 2-3 x D							
Diameter		/1	L	d2	magaforce 8500	Graph'X 8500-G	Hard'X 8500-H
(inch)	(mm)						
0.0020	0.05	0.004	1-1/2	0.118 3mm	8885000050		
0.0024	0.06	0.005					
0.0031	0.08	0.006					
0.0039	0.10	0.008					
0.0047	0.12	0.009					
0.0059	0.15	0.012					
0.0079	0.20	0.020					
0.0098	0.25	0.020					
0.0118	0.30	0.039					
0.0138	0.35	0.039					
0.0157	0.40	0.039					
0.0177	0.45	0.039					
0.0197	0.50	0.059					
0.0216	0.55	0.059					
0.0236	0.60	0.059					
0.0256	0.65	0.059					
0.0276	0.70	0.079					
0.0295	0.75	0.079					
0.0315	0.80	0.079					
0.0335	0.85	0.079					
0.0354	0.90	0.098					
0.0374	0.95	0.098					
0.0394	1.00	0.12					
0.0413	1.05	0.12					
0.0433	1.10	0.12					
0.0452	1.15	0.12					
0.0472	1.20	0.16					
0.0492	1.25	0.16					
0.0512	1.30	0.16					
0.0551	1.40	0.16					
0.0591	1.50	0.16					
0.0630	1.60	0.20					
0.0669	1.70	0.20					
0.0709	1.80	0.20					
0.0748	1.90	0.20					
0.0787	2.00	0.20					
0.0827	2.10	0.24					
0.0866	2.20	0.24					
0.0906	2.30	0.24					
0.0945	2.40	0.24					
0.0984	2.50	0.28					
0.1024	2.60	0.28					
0.1063	2.70	0.28					
0.1102	2.80	0.28					
0.1142	2.90	0.28					
0.1181	3.00	0.39					
0.1220	3.10	0.39					
			1-3/4	0.157 4mm	8885000300	888500G0300	888500H0300
					8885000310	888500G0310	888500H0310

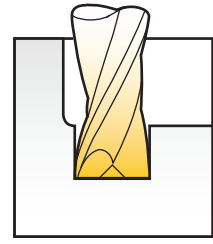

**Slotting
Engraving**

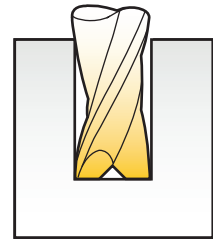

**Flat Bottom
Boring**

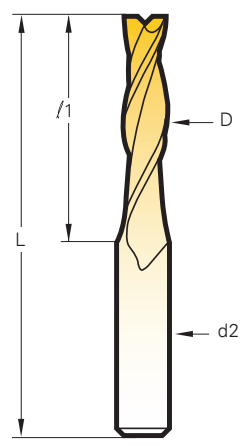

**K15 Carbide – 6.5 – 7% Cobalt
(0.006 – 0.008mm grain size)**

continued next page

Tolerances - inch	
0 – 0.0004	

Standard Length Miniature End-Mills



Continued from page 101

Standard Length Miniature End-Mills 2-3 x D					- / ~				
Diameter		/1	L	d2	magaforce 8500	Graph'X 8500-G	Hard'X 8500-H		
(inch)	(mm)								
0.1260	3.20	0.39	1-3/4	0.157 4mm	88850003200	888500G0320	888500H0320		
0.1299	3.30	0.39			88850003300	888500G0330	888500H0330		
0.1339	3.40	0.39			88850003400	888500G0340	888500H0340		
0.1378	3.50	0.39			88850003500	888500G0350	888500H0350		
0.1417	3.60	0.39			88850003600	888500G0360	888500H0360		
0.1457	3.70	0.39			88850003700	888500G0370	888500H0370		
0.1496	3.80	0.39			88850003800	888500G0380	888500H0380		
0.1535	3.90	0.39			88850003900	888500G0390	888500H0390		
0.1575	4.00	0.47			88850004000	888500G0400	888500H0400		
0.1614	4.10	0.47			88850004100	888500G0410	888500H0410		
0.1654	4.20	0.47	88850004200	888500G0420	888500H0420				
0.1693	4.30	0.47	1-1/2	0.118 3mm	88850004300	888500G0430	888500H0430		
0.1732	4.40	0.47			88850004400	888500G0440	888500H0440		
1.7720	4.50	0.47			88850004500	888500G0450	888500H0450		
0.1811	4.60	0.47			88850004600	888500G0460	888500H0460		
0.1850	4.70	0.47			88850004700	888500G0470	888500H0470		
0.1890	4.80	0.47			88850004800	888500G0480	888500H0480		
0.1929	4.90	0.47			88850004900	888500G0490	888500H0490		
0.1969	5.00	0.55			2-3/16	0.236 6mm	88850005000	888500G0500	888500H0500
0.2008	5.10	0.55					88850005100	888500G0510	888500H0510
0.2047	5.20	0.55					88850005200	888500G0520	888500H0520
0.2087	5.30	0.55	88850005300	888500G0530			888500H0530		
0.2126	5.40	0.55	88850005400	888500G0540			888500H0540		
0.2165	5.50	0.55	88850005500	888500G0550			888500H0550		
0.2205	5.60	0.55	88850005600	888500G0560			888500H0560		
0.2244	5.70	0.55	88850005700	888500G0570			888500H0570		
0.2283	5.80	0.55	88850005800	888500G0580			888500H0580		
0.2323	5.90	0.55	88850005900	888500G0590			888500H0590		



K15 Carbide

Long Miniature End-mills

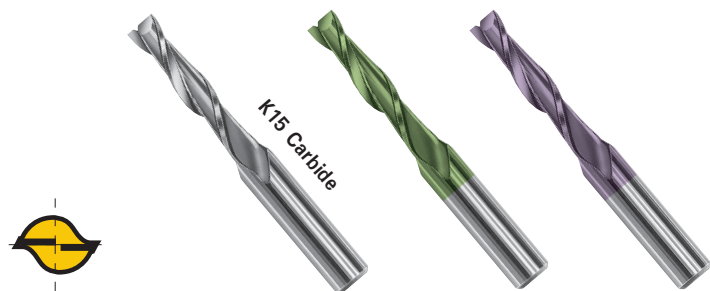

Long Series K15 Carbide			d2 = 0.118 L = 39mm / = 5 x D		
Diameter (inch)	(mm)	/1	magaforce 8509	Graph'X 8509-G	Hard'X 8509-H
0.0157	0.4	0.078	88850900400	888509G0040	888509H0040
0.0197	0.5	0.098	88850900500	888509G0050	888509H0050
0.0236	0.6	0.118	88850900600	888509G0060	888509H0060
0.0276	0.7	0.137	88850900700	888509G0070	888509H0070
0.0315	0.8	0.157	88850900800	888509G0080	888509H0080
0.0354	0.9	0.177	88850900900	888509G0090	888509H0090
0.0394	1.0	0.197	88850901000	888509G0100	888509H0100
0.0472	1.2	0.236	88850901200	888509G0120	888509H0120
0.0591	1.5	0.295	88850901500	888509G0150	888509H0150
0.0787	2.0	0.394	88850902000	888509G0200	888509H0200

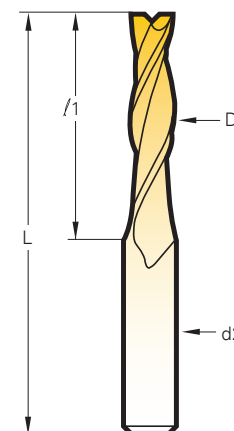

Tolerances - inch
0 - 0.0004

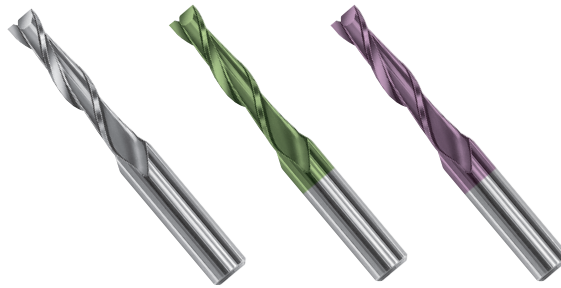

Extra-Long Series
K15 Carbide

$l = 8 \times D$

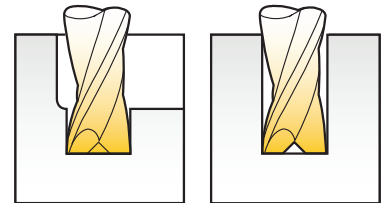

Slotting
Engraving

Flat Bottom
Boring

Diameter		/1	L	d2	magaforce 8510	Graph'X 8510-G	Hard'X 8510-H
(inch)	(mm)						
0.0197	0.5	0.157	1-1/2	0.118 3 mm	88851000500	888510G0050	888510H0050
0.0236	0.6	0.197			88851000600	888510G0060	888510H0060
0.0315	0.8	0.236			88851000800	888510G0080	888510H0080
0.0394	1.0	0.315			88851001000	888510G0100	888510H0100
0.0472	1.2	0.354	1-3/4	0.157 4 mm	88851001200	888510G0120	888510H0120
0.0591	1.5	0.472			88851001500	888510G0150	888510H0150
0.0787	2.0	0.630			88851002000	888510G0200	888510H0200
0.0984	2.5	0.788	2-3/8	0.197 5 mm	88851002500	888510G0250	888510H0250
0.1181	3.0	0.945			88851003000	888510G0300	888510H0300

Tolerances - inch

0 - 0.0004

Miniature End-mills with Back Clearance

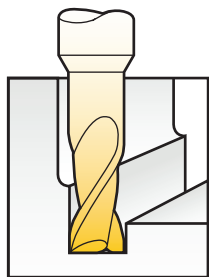

Hard to Reach
Machining

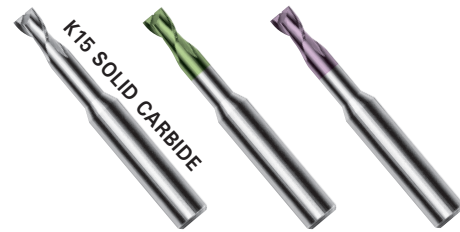

Long Neck Series
 $= 1.5 \times D$

$d2 = 0.188 / 3\text{mm} \quad /$

Diameter x /2		/1	L	magaforce 8507-D	K15/Graph'X 8507-DG	K15/Hard'X 8507-DH
(inch)	(mm)					
0.0157 x 0.078	0.4 x 2	0.024	1-1/2	888507D0042	888507DG0042	888507DH0042
0.0197 x 0.078	0.5 x 2	0.027	1-1/2	888507D0052	888507DG0052	888507DH0052
0.0197 x 0.157	0.5 x 4	0.027	1-1/2	888507D0054	888507DG0054	888507DH0054
0.0197 x 0.236	0.5 x 6	0.027	2-3/8	888507D0056	888507DG0056	888507DH0056
0.0236 x 0.157	0.6 x 4	0.029	1-1/2	888507D0064	888507DG0064	888507DH0064
0.0276 x 0.157	0.7 x 4	0.035	1-1/2	888507D0074	888507DG0074	888507DH0074
0.0315 x 0.157	0.8 x 4	0.041	1-1/2	888507D0084	888507DG0084	888507DH0084
0.0315 x 0.236	0.8 x 6	0.041	1-1/2	888507D0086	888507DG0086	888507DH0086
0.0315 x 0.354	0.8 x 9	0.041	2-3/8	888507D0089	888507DG0089	888507DH0089
0.0354 x 0.236	0.9 x 6	0.053	1-1/2	888507D0096	888507DG0096	888507DH0096
0.0394 x 0.157	1.0 x 4	0.059	1-1/2	888507D0140	888507DG014	888507DH014
0.0394 x 0.236	1.0 x 6	0.059	1-1/2	888507D0160	888507DG016	888507DH016
0.0394 x 0.354	1.0 x 9	0.059	1-1/2	888507D0190	888507DG019	888507DH019
0.0394 x 0.472	1.0 x 12	0.059	2-3/8	888507D0112	888507DG0112	888507DH0112
0.0472 x 0.236	1.2 x 6	0.071	1-1/2	888507D0126	888507DG0126	888507DH0126
0.0472 x 0.354	1.2 x 9	0.071	1-1/2	888507D0129	888507DG0129	888507DH0129
0.0551 x 0.236	1.4 x 6	0.083	1-1/2	888507D0146	888507DG0146	888507DH0146
0.0551 x 0.354	1.4 x 9	0.083	1-1/2	888507D0149	888507DG0149	888507DH0149
0.0591 x 0.236	1.5 x 6	0.089	1-1/2	888507D0156	888507DG0156	888507DH0156
0.0591 x 0.354	1.5 x 9	0.089	1-1/2	888507D0159	888507DG0159	888507DH0159
0.0591 x 0.472	1.5 x 12	0.089	2-3/8	888507D01512	888507DG01512	888507DH01512
0.0709 x 0.354	1.8 x 9	0.106	1-1/2	888507D0189	888507DG0189	888507DH0189
0.0709 x 0.472	1.8 x 12	0.106	1-1/2	888507D01812	888507DG01812	888507DH01812
0.0787 x 0.354	2.0 x 9	0.118	1-1/2	888507D0290	888507DG029	888507DH029
0.0787 x 0.472	2.0 x 12	0.118	1-1/2	888507D0212	888507DG0212	888507DH0212
0.0787 x 0.590	2.0 x 15	0.118	2-3/8	888507D0215	888507DG0215	888507DH0215
0.0984 x 0.590	2.5 x 15	0.148	2-3/8	888507D02515	888507DG02515	888507DH02515

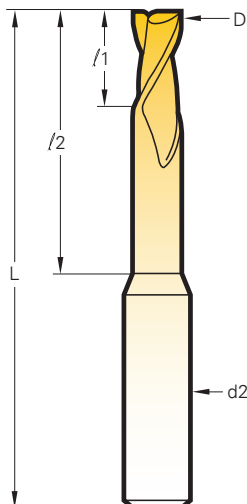



Performance Recommendations

- Endmills with long neck, extra-long neck, and deep machining: Reduce the speed, while maintaining the suggested feed.
- Superficial work: Increase the speed, while maintaining the suggested feed.

This chart lists general reference parameters for a starting point.

SFM: Surface Feet per Minute

RPM: Revolutions per Minute

IPT: Inches per Tooth (chip load)

IPM: Inches per Minute

IPR: Inches per Revolution

Speed Formula:

$$RPM = 3.82 \times (SFM \div \text{Diameter})$$

Feed:

$$IPM = IPT \times \# \text{ of Flutes} \times RPM$$

$$IPR = IPM \div RPM$$

$$SFM = RPM \times \text{Diameter} \div 3.82$$

Hard'X

Graph'X

Material	Diameter (inch - mm)	Hard'X				Graph'X			
		Speed SFM	RPM	IPT 2 Flute	IPM	Speed SFM	RPM	IPT 2 flute	IPM
Chromium / Cobalt	0.0197 - 0.5	82	15,900 – 28,504	0.0004	13 – 23	164	31,000 – 38,200	0.0004	25 – 30
	0.0394 - 1.0	~	7,950 – 14,252	0.0006	9.5 – 17	~	15,900 – 19,100	0.0006	19 – 23
	0.0787 - 2.0	147	3,980 – 7,135	0.0012	9.5 – 17	197	7,960 – 9,562	0.0012	19 – 23
	0.1575 - 4.0		1,989 – 3,565	0.0023	9 – 16		3,978 – 4,778	0.0023	18 – 22
Graphite, Plastic w/glass or carbon fibers	0.0197 - 0.5	197	38,200 – 57,203	0.0004	30 – 46	656	127,204 – 159,005	0.0004	102 - 127
	0.0394 - 1.0	~	19,100 – 28,602	0.0006	23 – 34	~	63,602 – 79,502	0.0006	76 – 95
	0.0787 - 2.0	295	9,562 – 14,189	0.0012	23 – 34	820	31,841 – 39,802	0.0012	76 – 95
	0.1575 - 4.0		4,778 – 7,155	0.0023	22 – 33		15,911 – 19,888	0.0023	73 - 91
Steel 24 ~ 44 HrC	0.0394 - 1.0	~	12,700 – 15,900	0.0003	7.5 - 9.5				
	0.0787 - 2.0	164	6,359 – 7,960	0.0007	9-11				
	0.1575 - 4.0		3,177 – 3,978	0.0014	9-11				
Treated Steel 45 ~ 55 HrC	0.0197 - 0.5	98	19,003 – 22,300	0.0001	3.8 - 4.5				
	0.0394 - 1.0	~	9,502 – 11,150	0.0002	3.8 - 4.5				
	0.0787 - 2.0	115	4,757 – 5,582	0.0004	3.8 - 4.5				
	0.1575 - 4.0		2,377 – 2,789	0.0008	3.8 - 4.5				
Treated Steel > 55 HrC	0.0197 - 0.5	49	9,502 – 11,798	0.00006	1.1 - 1.4				
	0.0394 - 1.0	~	4,750 – 6,399	0.00015	1.4 - 1.9				
	0.0787 - 2.0	66	2,378 – 3,204	0.00024	1.1 - 1.5				
	0.1575 - 4.0		1,188 – 1,600	0.00055	1.3 - 1.8				
Stainless Steel	0.0197 - 0.5	131	25,400 – 31,000	0.0002	10 – 12				
	0.0394 - 1.0	~	12,700 – 15,900	0.0004	10 – 13				
	0.0787 - 2.0	164	6,359 – 7,960	0.0008	10 – 13				
	0.1575 - 4.0		3,177 – 3,978	0.0019	12 – 15				
Super alloys Inconel / Waspaloy	0.0197 - 0.5	59	11,440 – 15,900	0.00004	1 – 1.3				
	0.0394 - 1.0	~	5,720 – 7,950	0.00012	1.4 - 1.9				
	0.0787 - 2.0	82	2,864 – 3,980	0.00016	1 – 1.3				
	0.1575 - 4.0		1,431 – 1,989	0.00032	1 – 1.3				
Titanium / Ti-alloy	0.0197 - 0.5	65	12,604 – 19,003	0.00008	2 – 3				
	0.0394 - 1.0	~	6,302 – 9,502	0.00024	3 – 4.5				
	0.0787 - 2.0	98	3,155 – 4,757	0.00032	2 – 3				
	0.1575 - 4.0		1,577 – 2,377	0.00059	1.9 - 2.8				
Ceramics	0.0197 - 0.5	229	44,405 – 57,203	0.0004	35 – 46				
	0.0394 - 1.0	~	22,203 – 28,602	0.0008	35 – 46				
	0.0787 - 2.0	295	11,115 – 14,189	0.0016	35 – 45				
	0.1575 - 4.0		5,554 – 7,155	0.0031	34 - 44				
Aluminum other plastics	0.0197 - 0.5	328	63,602 – 95,403	0.0004	51 – 76				
	0.0394 - 1.0	~	31,801 – 47,702	0.0006	38 – 57				
	0.0787 - 2.0	492	15,920 – 23,881	0.0012	38 – 57				
	0.1575 - 4.0		7,955 – 11,933	0.0023	36 - 55				
Copper / Brass / Bronze	0.0197 - 0.5	164	31,000 – 50,804	0.0004	25 – 41				
	0.0394 - 1.0	~	15,900 – 25,402	0.0006	19 – 30				
	0.0787 - 2.0	262	7,960 – 12,717	0.0012	19 – 30				
	0.1575 - 4.0		3,978 – 6,355	0.0023	18 - 29				



GMauvaisUSATM

High-Precision Micro Drills

PILLOT

Introduction	125
5140 Series HSS-E Cobalt 8% 2-3 x D, Center Cut – Pilot – Spot Drills 120°.....	126
5100 Series HSS-E Cobalt 8% 5 x D – Depth of Cut 120°.....	127-130
6140 Series Solid Carbide 2-3 x D, Center Cut – Pilot – Spot Drills 120°.....	131
6130 Series Solid Carbide 4-5 x D – Depth of Cut 120°.....	132-133
6120 Series Solid Carbide 4-5 x D – Depth of Cut 120°.....	134-137
6100 Series Solid Carbide 5-7 x D – Depth of Cut 120°.....	138-140
1100 Series Solid Carbide Half Round Gun Drills 10 x D – Depth of Cut 120°.....	141
6200 HP Series Solid Carbide High Performance! 6-7 x D – Depth of Cut 140°.....	142
6220 HP Series Solid Carbide High Performance! 12 x D – Depth of Cut 140°.....	143
6230 CT Series Coolant-Thru 15 x D – Depth of Cut 140°.....	144
62FLX Series Solid Carbide 30-40 x D – Depth of Cut 135°.....	145
3100 Series Short Solid Carbide 3 Flute SHORT Cross Drills 140°.....	146
3200 Series Long Solid Carbide 3 Flute LONG Reamer Drills 140°.....	147
62H1 Gun Drill - Single Flute Helicoidal Drills	148
Speeds and Feeds Chart	149





The Anatomy of a Superior Micro Drill

- Superior edge quality and flute surface finishes for high performance
- Extraordinary concentricity, circularity and straightness within 2 microns
- Consistent, accurate dimensions every time
- Amazing dimension control at h6, h4 and h3 μm tolerances
- Ultra-fine surface finish for smooth operation
- Superior HSS heat treating and 10% cobalt micro grain carbide for outstanding performance and long tool life



μm

What is a Micron?

1 micron = .001mm = .00003937"

One Hundredth (1/100) of a human hair

Superior Micro Drills...

Since 1928, GMauvaisUSA™ been delivering high precision micro drills in μm Micron tolerances to the Swiss Watch Industry. With innovative and unique manufacturing technologies in turning, bar cutting, grinding, milling, flute grinding, sharpening and heat-treating, the company produces products of the most consistent quality and reliable specifications, meeting their strict standards for superior quality. Their ability to control our high production operations with incredibly tight tolerances, makes us the right choice. Pilot Precision Products offers a complete range of products in solid carbide and cobalt high speed steel.

Operation	Series	
Centering	5140 6140 61CD	
Pivot/Spot	5140 6140 61CD	
Drilling	5100 6120 6130	
	6100 6200 3200	
	6220 6230 CT	
Cross-Drilling	3100 3200	



**Superior Precision,
Quality, Consistency and
Performance**

5140 Series HSS-E Cobalt 8%

2-3 x D, Center Cut – Pilot – Spot Drills 120°

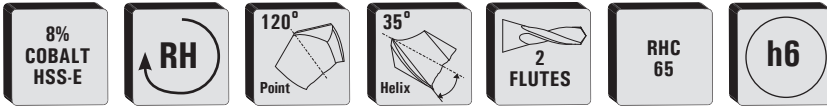

+ 0.000/- 0.006mm (h6)

For use prior to using 5100 series drills. Can also be used as a drill with 2-3 x D Depth.
 All items can be ordered as left hand at same pricing. Special, custom specification items available.

Custom specifications such as:

- Helix angle of 15°, 24°, 30° or other
- Point angles of 90°, 110°, 130°, 140° or other
- Special diameters of 1.255mm or other
- Special tolerances as +/- 0.001mm or other
- Coatings available upon request
- Minimum custom order is 10 pieces
- **Lead-time on custom orders—4 weeks ARO**

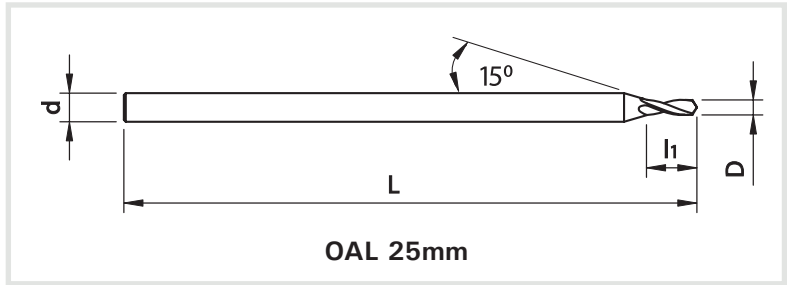

5140 Series HSS-E Cobalt 8% - Drill Sizes 0.20 – 3.00mm
 NOTE: Sold in 10 piece packages only

D Flute Dia. (mm)	D Dec. Equiv. Flute Dia. (inch)	Wire # Frac	d Shank Dia. (mm)	l1 Flute Length (mm)	L Overall Length OAL (mm)	Uncoated (R) EDP No.
0.20	0.0079	92	1.5	0.6	25.0	5140020R
0.25	0.0098			0.8		5140025R
0.30	0.0118			0.9		5140030R
0.35	0.0138			1.0		5140035R
0.40	0.0157			1.2		5140040R
0.45	0.0177			1.4		5140045R
0.50	0.0197			1.7		5140050R
0.55	0.0217			2.0		5140055R
0.60	0.0236			2.3		5140060R
0.65	0.0256			2.7		5140065R
0.70	0.0276			3.0		5140070R
0.75	0.0295					5140075R
0.80	0.0315					5140080R
0.85	0.0335					5140085R
0.90	0.0354					5140090R
0.95	0.0374					5140095R
1.00	0.0394			5140100R		
1.05	0.0413			5140105R		
1.10	0.0433			5140110R		
1.15	0.0453			5140115R		
1.20	0.0472			5140120R		
1.25	0.0492			5140125R		
1.30	0.0512			5140130R		
1.35	0.0531			5140135R		
1.40	0.0551	54		5140140R		
1.45	0.0571			5140145R		
1.50	0.0591		2.0	5140150R		
1.60	0.0630	51		5140160R		

5140 Series HSS-E Cobalt 8% - Drill Sizes 0.20 – 3.00mm

D Flute Dia. (mm)	D Dec. Equiv. Flute Dia. (inch)	Wire # Frac	d Shank Dia. (mm)	l1 Flute Length (mm)	L Overall Length OAL (mm)	Uncoated (R) EDP No.
1.70	0.0669		2.0	3.3	25.0	5140170R
1.80	0.0709			4.0		5140180R
1.90	0.0748			4.6		5140190R
2.00	0.0787			5.3		5140200R
2.10	0.0827		2.5	4.0		5140210R
2.20	0.0866			4.6		5140220R
2.30	0.0906			5.3		5140230R
2.40	0.0945			4.6		5140240R
2.50	0.0984		3.0	4.6		5140250R
2.60	0.1024			5.3		5140260R
2.70	0.1063			4.6	5140270R	
2.80	0.1102			5.3	5140280R	
2.90	0.1142			5140290R		
3.00	0.1181			5140300R		

Pilot Drills

- For use prior to using 5100 series drills
- Can be used as pilot drill with 2-3 x D Depth

5100 Series HSS-E Cobalt 8%

5 x D – Depth of Cut 120°



+ 0.000/- 0.006mm (h6)

For materials with long forming chips, steel up to 35 rhc, copper, stainless, titanium.

All items can be ordered as left hand at same pricing. Special, custom specification items available.

Custom specifications such as:

- Helix angle of 15°, 30°, 35° or other
- Point angles of 90°, 110°, 130°, 140° or other
- Special diameters of 1.255mm or other
- Special tolerances as +/- 0.001mm or other
- Coatings available upon request
- Minimum custom order is 10 Pieces
- **Lead-time on custom orders—4 weeks ARO**

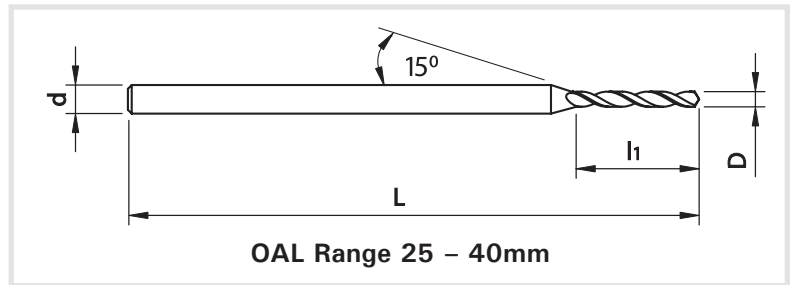

5100 Series HSS-E Cobalt 8% - Drill Sizes 0.10 – 0.65mm
NOTE: Sold in 10 piece packages only

D Flute Dia. (mm)	D Dec. Equiv. Flute Dia. (inch)	Wire # Frac	d Shank Dia. (mm)	l1 Flute Length (mm)	L Overall Length OAL (mm)	Uncoated (R) EDP No.			
0.10	0.0039		1.0	0.7	25	5100010R			
0.11	0.0043					5100011R			
0.12	0.0047					5100012R			
0.13	0.0051			5100013R					
0.14	0.0055			5100014R					
0.15	0.0059	97		5100015R					
0.16	0.0063	96		5100016R					
0.17	0.0067	95		5100017R					
0.18	0.0071	94		5100018R					
0.19	0.0075	93		5100019R					
0.20	0.0079	92		5100020R					
0.21	0.0083	91		5100021R					
0.22	0.0087	90		5100022R					
0.23	0.0091	89		5100023R					
0.24	0.0094	88		5100024R					
0.25	0.0098			5100025R					
0.26	0.0102			5100026R					
0.27	0.0106	86		5100027R					
0.28	0.0110	85		5100028R					
0.29	0.0114	84		5100029R					
0.30	0.0118			5100030R					
0.31	0.0122			5100031R					
0.32	0.0126	82		5100032R					
0.33	0.0130	81		5100033R					
0.34	0.0134	80		5100034R					
0.35	0.0138			5100035R					
0.36	0.0142			5100036R					
0.37	0.0146	79		5100037R					
				2.2		2.8			

5100 Series HSS-E Cobalt 8% - Drill Sizes 0.10 – 0.65mm

D Flute Dia. (mm)	D Dec. Equiv. Flute Dia. (inch)	Wire # Frac	d Shank Dia. (mm)	l1 Flute Length (mm)	L Overall Length OAL (mm)	Uncoated (R) EDP No.
0.38	0.0150		1	2.8	25	5100038R
0.39	0.0154			5100039R		
0.40	0.0157			5100040R		
0.41	0.0161	78		5100041R		
0.42	0.0165			5100042R		
0.43	0.0169			5100043R		
0.44	0.0173			5100044R		
0.45	0.0177			5100045R		
0.46	0.0181	77		5100046R		
0.47	0.0185			5100047R		
0.48	0.0189		5100048R			
0.49	0.0193		5100049R			
0.50	0.0197		1.5	4.0		5100050R
0.51	0.0201	76			5100051R	
0.52	0.0205				5100052R	
0.53	0.0209	75			5100053R	
0.54	0.0213				5100054R	
0.55	0.0217			5100055R		
0.56	0.0220			4.5		5100056R
0.57	0.0224	74			5100057R	
0.58	0.0228				5100058R	
0.59	0.0232				5100059R	
0.60	0.0236		5100060R			
0.61	0.0240	73	4.7		5100061R	
0.62	0.0244			5100062R		
0.63	0.0248	72		5100063R		
0.64	0.0252			5100064R		
0.65	0.0256			5100065R		

Series 5100 Continued

5100 Series HSS-E Cobalt 8%

5 x D – Depth of Cut 120°, continued



5100 Series HSS-E Cobalt 8% - Drill Sizes 0.66 – 1.59mm
NOTE: Sold in 10 piece packages only

D Flute Dia. (mm)	D Dec. Equiv. Flute Dia. (inch)	Wire # Frac	d Shank Dia. (mm)	I1 Flute Length (mm)	L Overall Length OAL (mm)	Uncoated (R) EDP No.
0.66	0.0260	71		4.7	25.0	5100066R
0.67	0.0264					5100067R
0.68	0.0268					5100068R
0.69	0.0272			5100069R		
0.70	0.0276			5100070R		
0.71	0.0280	70		5.2		5100071R
0.72	0.0283					5100072R
0.73	0.0287					5100073R
0.74	0.0291	69				5100074R
0.75	0.0295					5100075R
0.76	0.0299					5100076R
0.77	0.0303			5100077R		
0.78	0.0307		5100078R			
0.79	0.0311	68-1/32	5.5	5100079R		
0.80	0.0315			5100080R		
0.81	0.0319	67		5100081R		
0.82	0.0323			5100082R		
0.83	0.0327			5100083R		
0.84	0.0331	66		5100084R		
0.85	0.0335			5100085R		
0.86	0.0339			5100086R		
0.87	0.0343			5100087R		
0.88	0.0346			5100088R		
0.89	0.0350	65	6.0	5100089R		
0.90	0.0354			5100090R		
0.91	0.0358	64		5100091R		
0.92	0.0362			5100092R		
0.93	0.0366			5100093R		
0.94	0.0370	63		5100094R		
0.95	0.0374			5100095R		
0.96	0.0378	62		5100096R		
0.97	0.0382			5100097R		
0.98	0.0386			5100098R		
0.99	0.0390	61	6.5	5100099R		
1.00	0.0394			5100100R		
1.01	0.0398	60		5100101R		
1.02	0.0402			5100102R		
1.03	0.0406			5100103R		
1.04	0.0409	59		5100104R		
1.05	0.0413			5100105R		
1.06	0.0417			5100106R		
1.07	0.0421	58		5100107R		
1.08	0.0425			5100108R		
1.09	0.0429	57	7.0	5100109R		
1.10	0.0433			5100110R		
1.11	0.0437			5100111R		
1.12	0.0441			5100112R		

5100 Series HSS-E Cobalt 8% - Drill Sizes 1.60 – 2.53mm

D Flute Dia. (mm)	D Dec. Equiv. Flute Dia. (inch)	Wire # Frac	d Shank Dia. (mm)	I1 Flute Length (mm)	L Overall Length OAL (mm)	Uncoated (R) EDP No.
1.13	0.0445		1.5	7.0	25.0	5100113R
1.14	0.0449					5100114R
1.15	0.0453					5100115R
1.16	0.0457					5100116R
1.17	0.0461					5100117R
1.18	0.0465	56				5100118R
1.19	0.0469	3/64		5100119R		
1.20	0.0472			7.5		5100120R
1.21	0.0476					5100121R
1.22	0.0480					5100122R
1.23	0.0484					5100123R
1.24	0.0488					5100124R
1.25	0.0492		5100125R			
1.26	0.0496		8.5	5100126R		
1.27	0.0500			5100127R		
1.28	0.0504			5100128R		
1.29	0.0508			5100129R		
1.30	0.0512			5100130R		
1.31	0.0516			5100131R		
1.32	0.0520	55		5100132R		
1.33	0.0524			5100133R		
1.34	0.0528			5100134R		
1.35	0.0531			5100135R		
1.36	0.0535		5100136R			
1.37	0.0539		5100137R			
1.38	0.0543		5100138R			
1.39	0.0547		5100139R			
1.40	0.0551	54	2.0	5100140R		
1.41	0.0555			5100141R		
1.42	0.0559			5100142R		
1.43	0.0563			5100143R		
1.44	0.0567			5100144R		
1.45	0.0571			5100145R		
1.46	0.0575			5100146R		
1.47	0.0579			5100147R		
1.48	0.0583			5100148R		
1.49	0.0587			5100149R		
1.50	0.0591		10.0	5100150R		
1.51	0.0594	53		5100151R		
1.52	0.0598			5100152R		
1.53	0.0602			5100153R		
1.54	0.0606			5100154R		
1.55	0.0610			5100155R		
1.56	0.0614			5100156R		
1.57	0.0618			5100157R		
1.58	0.0622			5100158R		
1.59	0.0626	1/16	5100159R			

Series 5100 Continued

5100 Series HSS-E Cobalt 8%

5 x D – Depth of Cut 120°, continued



5100 Series HSS-E Cobalt 8% - Drill Sizes 1.60 – 2.53mm
 NOTE: Sold in 10 piece packages only

D Flute Dia. (mm)	D Dec. Equiv. Flute Dia. (inch)	Wire # Frac	d Shank Dia. (mm)	I1 Flute Length (mm)	L Overall Length OAL (mm)	Uncoated (R) EDP No.
1.60	0.0630		2.0	10.0	35.0	5100160R
1.61	0.0634	52				5100161R
1.62	0.0638					5100162R
1.63	0.0642					5100163R
1.64	0.0646					5100164R
1.65	0.0650					5100165R
1.66	0.0654					5100166R
1.67	0.0657					5100167R
1.68	0.0661					5100168R
1.69	0.0665					5100169R
1.70	0.0669	51				5100170R
1.71	0.0673					5100171R
1.72	0.0677					5100172R
1.73	0.0681					5100173R
1.74	0.0685		5100174R			
1.75	0.0689		5100175R			
1.76	0.0693		5100176R			
1.77	0.0697		5100177R			
1.78	0.0701	50	5100178R			
1.79	0.0705		5100179R			
1.80	0.0709		5100180R			
1.81	0.0713		5100181R			
1.82	0.0717		5100182R			
1.83	0.0720		5100183R			
1.84	0.0724		5100184R			
1.85	0.0728	49	5100185R			
1.86	0.0732		5100186R			
1.87	0.0736		5100187R			
1.88	0.0740		5100188R			
1.89	0.0744		5100189R			
1.90	0.0748		5100190R			
1.91	0.0752		5100191R			
1.92	0.0756		5100192R			
1.93	0.0760	48	5100193R			
1.94	0.0764		5100194R			
1.95	0.0768		5100195R			
1.96	0.0772		5100196R			
1.97	0.0776		5100197R			
1.98	0.0780	5/64	5100198R			
1.99	0.0783	47	5100199R			
2.00	0.0787		5100200R			
2.01	0.0791		5100201R			
2.02	0.0795		5100202R			
2.03	0.0799		5100203R			
2.04	0.0803		5100204R			
2.05	0.0807		5100205R			
2.06	0.0811	46	5100206R			

5100 Series HSS-E Cobalt 8% - Drill Sizes 1.60 – 2.53mm

D Flute Dia. (mm)	D Dec. Equiv. Flute Dia. (inch)	Wire # Frac	d Shank Dia. (mm)	I1 Flute Length (mm)	L Overall Length OAL (mm)	Uncoated (R) EDP No.
2.07	0.0815		2.5	12.0	35.0	5100207R
2.08	0.0819	45				5100208R
2.09	0.0823					5100209R
2.10	0.0827					5100210R
2.11	0.0831					5100211R
2.12	0.0835					5100212R
2.13	0.0839					5100213R
2.14	0.0843					5100214R
2.15	0.0846					5100215R
2.16	0.0850					5100216R
2.17	0.0854					5100217R
2.18	0.0858	44				5100218R
2.19	0.0862					5100219R
2.20	0.0866					5100220R
2.21	0.0870		5100221R			
2.22	0.0874		5100222R			
2.23	0.0878		5100223R			
2.24	0.0882		5100224R			
2.25	0.0886		5100225R			
2.26	0.0890	43	5100226R			
2.27	0.0894		5100227R			
2.28	0.0898		5100228R			
2.29	0.0902		5100229R			
2.30	0.0906		5100230R			
2.31	0.0909		5100231R			
2.32	0.0913		5100232R			
2.33	0.0917		5100233R			
2.34	0.0921		5100234R			
2.35	0.0925		5100235R			
2.36	0.0929		5100236R			
2.37	0.0933		5100237R			
2.38	0.0937	3/32	5100238R			
2.39	0.0941		5100239R			
2.40	0.0945		5100240R			
2.41	0.0949		5100241R			
2.42	0.0953		5100242R			
2.43	0.0957		5100243R			
2.44	0.0961	41	5100244R			
2.45	0.0965		5100245R			
2.46	0.0969		5100246R			
2.47	0.0972		5100247R			
2.48	0.0976		5100248R			
2.49	0.0980	40	5100249R			
2.50	0.0984		5100250R			
2.51	0.0988		5100251R			
2.52	0.0992		5100252R			
2.53	0.0996	39	5100253R			

Series 5100 Continued

5100 Series HSS-E Cobalt 8%

5 x D – Depth of Cut 120°, continued

5100 Series HSS-E Cobalt 8% - Drill Sizes 2.54 – 3.00mm
 NOTE: Sold in 10 piece packages only

D Flute Dia. (mm)	D Dec. Equiv. Flute Dia. (inch)	Wire # Frac	d Shank Dia. (mm)	l1 Flute Length (mm)	L Overall Length OAL (mm)	Uncoated (R) EDP No.
2.54	0.1000		3.0	16.0	40.0	5100254R
2.55	0.1004					5100255R
2.56	0.1008					5100256R
2.57	0.1012					5100257R
2.58	0.1016	38				5100258R
2.59	0.1020					5100259R
2.60	0.1024					5100260R
2.61	0.1028					5100261R
2.62	0.1031					5100262R
2.63	0.1035					5100263R
2.64	0.1039	37				5100264R
2.65	0.1043					5100265R
2.66	0.1047					5100266R
2.67	0.1051					5100267R
2.68	0.1055					5100268R
2.69	0.1059					5100269R
2.70	0.1063	36				5100270R
2.71	0.1067					5100271R
2.72	0.1071					5100272R
2.73	0.1075					5100273R
2.74	0.1079			5100274R		
2.75	0.1083			5100275R		
2.76	0.1087			5100276R		
2.77	0.1091			18.0	5100277R	

5100 Series HSS-E Cobalt 8% - Drill Sizes 2.54 – 3.00mm

D Flute Dia. (mm)	D Dec. Equiv. Flute Dia. (inch)	Wire # Frac	d Shank Dia. (mm)	l1 Flute Length (mm)	L Overall Length OAL (mm)	Uncoated (R) EDP No.
2.78	0.1094	7/64	3.0	18.0	40.0	5100278R
2.79	0.1098	35				5100279R
2.80	0.1102					5100280R
2.81	0.1106					5100281R
2.82	0.1110	34				5100282R
2.83	0.1114					5100283R
2.84	0.1118					5100284R
2.85	0.1122					5100285R
2.86	0.1126					5100286R
2.87	0.1130	33				5100287R
2.88	0.1134					5100288R
2.89	0.1138					5100289R
2.90	0.1142					5100290R
2.91	0.1146					5100291R
2.92	0.1150					5100292R
2.93	0.1154					5100293R
2.94	0.1157					5100294R
2.95	0.1161	32				5100295R
2.96	0.1165					5100296R
2.97	0.1169					5100297R
2.98	0.1173					5100298R
2.99	0.1177					5100299R
3.00	0.1181					5100300R

5100 Series HSS-E Cobalt 8%



- For materials with long forming chips, steel up to 35 RHC, Copper, Stainless, Titanium
- Amazing dimension control at h6, h4 & h3 μm tolerances
- Ultra-fine surface finish for smooth operation
- Superb heat treating for outstanding performance & long tool life
- Coatings available upon request

6140 Series Solid Carbide

2-3 x D, Center Cut – Pilot – Spot Drills 120°



10% COBALT
MICRO
GRAIN
CARBIDE

RH

120°
Point

24°
Helix

2
FLUTES

RHC
65

h6

+ 0.000/- 0.006mm (h6) Uncoated Version
+ 0.002/-0.004mm Coated Version

**For use prior to using 6120 and 6100 series drills. Can also be used as a drill with 2–3 x D depth.
All items can be ordered as left hand at same pricing. Special, custom specification items available.**

Custom specifications such as:

- Helix angle of 15°, 30°, 35° or other
- Point angles of 90°, 110°, 130°, 140° or other
- Special diameters as 0.92mm or other
- Special tolerances as +/- 0.001mm or other
- Coolant thru drills at 3 and 4mm shanks and 1.25 to 3mm flute diameters
- Coatings available upon request
- Minimum custom order is 10 Pieces
- 4mm for specials
- **Lead-time on custom orders—4 Weeks ARO**

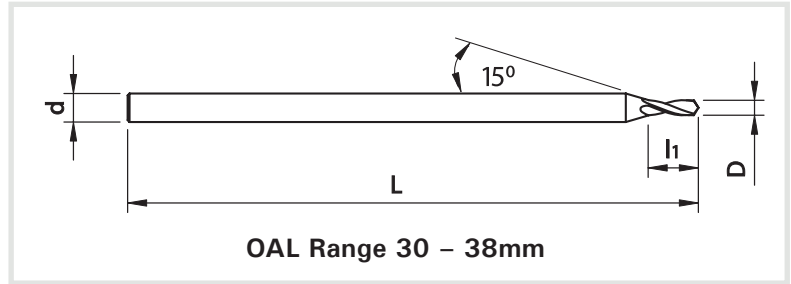

Non-stock: allow 4 weeks for delivery

6140 Series Solid Carbide* - Drill Sizes 0.20 – 3.00mm
NOTE: Sold in 10 piece packages only

D Flute Dia. (mm)	D Dec. Equiv. Flute Dia. (inch)	Wire # Frac	d Shank Dia. (mm)	l1 Flute Length (mm)	L Overall Length OAL (mm)	Uncoated (R) EDP No.	TiAlN Coated (RC) EDP No.
0.20	0.0079	92	1.5	.9	30.0	6140020R	-
0.25	0.0098					6140025R	-
0.30	0.0118					6140030R	-
0.35	0.0138					6140035R	-
0.40	0.0157					6140040R	-
0.45	0.0177					6140045R	-
0.50	0.0197			6140050R	6140050RC		
0.55	0.0217			6140055R	6140055RC		
0.60	0.0236			6140060R	6140060RC		
0.65	0.0256			6140065R	6140065RC		
0.70	0.0276			6140070R	6140070RC		
0.75	0.0295			6140075R	6140075RC		
0.80	0.0315			6140080R	6140080RC		
0.85	0.0335			6140085R	6140085RC		
0.90	0.0354			6140090R	6140090RC		
0.95	0.0374			6140095R	6140095RC		
1.00	0.0394		6140100R	6140100RC			
1.05	0.0413		6140105R	6140105RC			
1.10	0.0433		6140110R	6140110RC			
1.15	0.0453		6140115R	6140115RC			
1.20	0.0472		6140120R	6140120RC			

6140 Series Solid Carbide - Drill Sizes 0.20 – 3.00mm

D Flute Dia. (mm)	D Dec. Equiv. Flute Dia. (inch)	Wire # Frac	d Shank Dia. (mm)	l1 Flute Length (mm)	L Overall Length OAL (mm)	Uncoated (R) EDP No.	TiAlN Coated (RC) EDP No.	
1.25	0.0492		1.5	4.2	30.0	6140125R	6140125RC	
1.30	0.0512					6140130R	6140130RC	
1.35	0.0531					6140135R	6140135RC	
1.40	0.0551	54		4.7		38.0	6140140R	6140140RC
1.45	0.0571						6140145R	6140145RC
1.50	0.0591						6140150R	6140150RC
1.60	0.0630	51	5.4	38.0	6140160R		6140160RC	
1.70	0.0669				6140170R		6140170RC	
1.80	0.0709				6140180R		6140180RC	
1.90	0.0748		6.5		38.0	6140190R	6140190RC	
2.00	0.0787					6140200R	6140200RC	
2.10	0.0827					6140210R	6140210RC	
2.20	0.0866		6.5	38.0		6140220R	6140220RC	
2.30	0.0906					6140230R	6140230RC	
2.40	0.0945					6140240R	6140240RC	
2.50	0.0984		7.5		38.0	6140250R	6140250RC	
2.60	0.1024					6140260R	6140260RC	
2.70	0.1063					6140270R	6140270RC	
2.80	0.1102		7.5	38.0		6140280R	6140280RC	
2.90	0.1142					6140290R	6140290RC	
3.00	0.1181					6140300R	6140300RC	

***SPECIAL ORDERS:** Series 6140 flute diameters coated sizes smaller than 0.50mm are special order. Please contact Pilot Precision Products for details at 413-350-5200.

6130 Series Solid Carbide

4-5 x D – Depth of Cut 120°



h6 Tolerance Reinforced Shank d 3.0mm

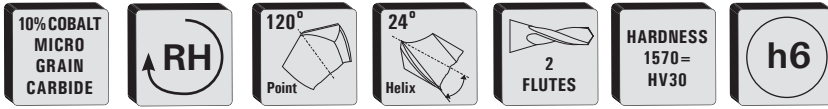

+ 0.000/- 0.006mm (h6) Uncoated Version
+ 0.002/-0.004mm Coated Version

For soft, medium to high tensile strength steel, stainless, titanium alloys and cast iron.
All items can be ordered as left hand at same pricing. Special, custom specification items available.

Custom specifications such as:

- Helix angle of 15°, 30°, 35° or other
- Point Angles of 90°, 110°, 130°, 140° or other
- Special Diameters as 1.255mm or other
- Special Tolerances as +/- 0.001mm or other
- Minimum custom order is 10 pieces
- 4mm for specials
- **Lead-Time on custom orders—4 Weeks ARO**

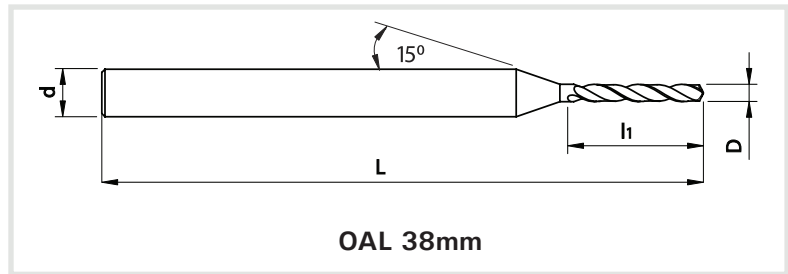

OAL 38mm

Non-stock: allow 4 weeks for delivery

6130 Series Solid Carbide - Drill Sizes 0.20 – 0.88mm

NOTE: Sold in 10 piece packages only

D Flute Dia. (mm)	D Dec. Equiv. Flute Dia. (inch)	Wire #	d Shank Dia. (mm)	l1 Flute Length (mm)	L Overall Length OAL (mm)	Uncoated (R) EDP No.	TiAlN Coated (RC) EDP No.
0.20	0.0079	92	3.0	1.1	38.0	6130020R	-
0.21	0.0083	91				6130021R	-
0.22	0.0087	90				6130022R	-
0.23	0.0091	89				6130023R	-
0.24	0.0094	88				6130024R	-
0.25	0.0098					6130025R	-
0.26	0.0102					6130026R	-
0.27	0.0106	86				6130027R	-
0.28	0.0110	85				6130028R	-
0.29	0.0114	84				6130029R	-
0.30	0.0118			6130030R		-	
0.31	0.0122			6130031R		-	
0.32	0.0126	82		6130032R		-	
0.33	0.0130	81		6130033R		-	
0.34	0.0134	80		6130034R		-	
0.35	0.0138			6130035R		-	
0.36	0.0142			6130036R		-	
0.37	0.0146	79		6130037R		-	
0.38	0.0150			6130038R		-	
0.39	0.0154			6130039R		-	
0.40	0.0157			6130040R		-	
0.41	0.0161	78		6130041R		-	
0.42	0.0165			6130042R		-	
0.43	0.0169			6130043R		-	
0.44	0.0173			6130044R		-	
0.45	0.0177			6130045R		-	
0.46	0.0181	77		6130046R		-	
0.47	0.0185			6130047R		-	
0.48	0.0189			6130048R		-	
0.49	0.0193			6130049R		-	
0.50	0.0197		6130050R	6130050RC			
0.51	0.0201	76	6130051R	6130051RC			
0.52	0.0205		6130052R	6130052RC			
0.53	0.0209	75	6130053R	6130053RC			
0.54	0.0213		6130054R	6130054RC			

6130 Series Solid Carbide - Drill Sizes 0.20 – 0.88mm

D Flute Dia. (mm)	D Dec. Equiv. Flute Dia. (inch)	Wire #	d Shank Dia. (mm)	l1 Flute Length (mm)	L Overall Length OAL (mm)	Uncoated (R) EDP No.	TiAlN Coated (RC) EDP No.
0.55	0.0217		3.0	2.8	38.0	6130055R	6130055RC
0.56	0.0220					6130056R	6130056RC
0.57	0.0224	74				6130057R	6130057RC
0.58	0.0228					6130058R	6130058RC
0.59	0.0232					6130059R	6130059RC
0.60	0.0236					6130060R	6130060RC
0.61	0.0240	73				6130061R	6130061RC
0.62	0.0244					6130062R	6130062RC
0.63	0.0248	72				6130063R	6130063RC
0.64	0.0252					6130064R	6130064RC
0.65	0.0256			6130065R		6130065RC	
0.66	0.0260	71		6130066R		6130066RC	
0.67	0.0264			6130067R		6130067RC	
0.68	0.0268			6130068R		6130068RC	
0.69	0.0272			6130069R		6130069RC	
0.70	0.0276			6130070R		6130070RC	
0.71	0.0280	70		6130071R		6130071RC	
0.72	0.0283			6130072R		6130072RC	
0.73	0.0287			6130073R		6130073RC	
0.74	0.0291	69		6130074R		6130074RC	
0.75	0.0295			6130075R		6130075RC	
0.76	0.0299			6130076R		6130076RC	
0.77	0.0303			6130077R		6130077RC	
0.78	0.0307			6130078R		6130078RC	
0.79	0.0311	68-1/32		6130079R		6130079RC	
0.80	0.0315			6130080R		6130080RC	
0.81	0.0319	67		6130081R		6130081RC	
0.82	0.0323			6130082R		6130082RC	
0.83	0.0327			6130083R		6130083RC	
0.84	0.0331	66		6130084R		6130084RC	
0.85	0.0335		6130085R	6130085RC			
0.86	0.0339		6130086R	6130086RC			
0.87	0.0343		6130087R	6130087RC			
0.88	0.0346		6130088R	6130088RC			

Series 6130 Continued

*SPECIAL ORDERS: Series 6130 flute diameters coated sizes smaller than 0.50mm are special order. Please contact Pilot Precision Products for details.

6130 Series Solid Carbide

4-5 x D – Depth of Cut 120°, continued

Non-stock: allow 4 weeks for delivery

6130 Series Solid Carbide - Drill Sizes 0.89–1.99 mm x 3mm Shank Tools <i>NOTE: Sold in 10 piece packages only</i>							
D Flute Dia. (mm)	D Dec. Equiv. Flute Dia. (inch)	Wire # Frac	d Shank Dia. (mm)	l1 Flute length (mm)	L Overall Length OAL (mm)	Uncoated (R) EDP No.	TiAlN Coated (RC) EDP No.
0.89	0.0350	65	3.0	4.8	38.0	6130089R	6130089RC
0.90	0.0354					6130090R	6130090RC
0.91	0.0358	64				6130091R	6130091RC
0.92	0.0362					6130092R	6130092RC
0.93	0.0366					6130093R	6130093RC
0.94	0.0370	63				6130094R	6130094RC
0.95	0.0374					6130095R	6130095RC
0.96	0.0378	62				6130096R	6130096RC
0.97	0.0382					6130097R	6130097RC
0.98	0.0386					6130098R	6130098RC
0.99	0.0390	61				6130099R	6130099RC
1.00	0.0394					6130100R	6130100RC
1.01	0.0398	60				6130101R	6130101RC
1.02	0.0402					6130102R	6130102RC
1.03	0.0406					6130103R	6130103RC
1.04	0.0409	59				6130104R	6130104RC
1.05	0.0413					6130105R	6130105RC
1.06	0.0417					6130106R	6130106RC
1.07	0.0421	58				6130107R	6130107RC
1.08	0.0425					6130108R	6130108RC
1.09	0.0429	57		6130109R		6130109RC	
1.100	0.0433			6130110R		6130110RC	
1.11	0.0437			6130111R		6130111RC	
1.12	0.0441			6130112R		6130112RC	
1.13	0.0445			6130113R		6130113RC	
1.14	0.0449			6130114R		6130114RC	
1.15	0.0453			6130115R		6130115RC	
1.16	0.0457			6130116R		6130116RC	
1.17	0.0461			6130117R		6130117RC	
1.18	0.0465	56		6130118R		6130118RC	
1.19	0.0469	3/64		6130119R		6130119RC	
1.20	0.0472			6130120R		6130120RC	
1.21	0.0476			6130121R		6130121RC	
1.22	0.0480			6130122R		6130122RC	
1.23	0.0484			6130123R		6130123RC	
1.24	0.0488			6130124R		6130124RC	
1.25	0.0492			6130125R		6130125RC	
1.26	0.0496			6130126R		6130126RC	
1.27	0.0500			6130127R		6130127RC	
1.28	0.0504			6130128R		6130128RC	
1.29	0.0508		6130129R	6130129RC			
1.30	0.0512		6130130R	6130130RC			
1.31	0.0516		6130131R	6130131RC			
1.32	0.0520	55	6130132R	6130132RC			
1.33	0.0524		6130133R	6130133RC			
1.34	0.0528		6130134R	6130134RC			
1.35	0.0531		6130135R	6130135RC			
1.36	0.0535		6130136R	6130136RC			
1.37	0.0539		6130137R	6130137RC			
1.38	0.0543		6130138R	6130138RC			
1.39	0.0547		6130139R	6130139RC			
1.40	0.0551	54	6130140R	6130140RC			
1.41	0.0555		6130141R	6130141RC			
1.42	0.0559		6130142R	6130142RC			
1.43	0.0563		6130143R	6130143RC			
1.44	0.0567		6130144R	6130144RC			

6130 Series Solid Carbide - Drill Sizes 0.89–1.99 mm x 3mm Shank Tools							
D Flute Dia. (mm)	D Dec. Equiv. Flute Dia. (inch)	Wire # Frac	d Shank Dia. (mm)	l1 Flute Length (mm)	L Overall Length OAL (mm)	Uncoated (R) EDP No.	TiAlN Coated (RC) EDP No.
1.45	0.0571		3.0	6.7	38.0	6130145R	6130145RC
1.46	0.0575					6130146R	6130146RC
1.47	0.0579					6130147R	6130147RC
1.48	0.0583					6130148R	6130148RC
1.49	0.0587					6130149R	6130149RC
1.50	0.0591					6130150R	6130150RC
1.51	0.0594	53				6130151R	6130151RC
1.52	0.0598					6130152R	6130152RC
1.53	0.0602					6130153R	6130153RC
1.54	0.0606					6130154R	6130154RC
1.55	0.0610			6130155R		6130155RC	
1.56	0.0614			6130156R		6130156RC	
1.57	0.0618			6130157R		6130157RC	
1.58	0.0622			6130158R		6130158RC	
1.59	0.0626	1/16		6130159R		6130159RC	
1.60	0.0630			6130160R		6130160RC	
1.61	0.0634	52		6130161R		6130161RC	
1.62	0.0638			6130162R		6130162RC	
1.63	0.0642			6130163R		6130163RC	
1.64	0.0646			6130164R		6130164RC	
1.65	0.0650		6130165R	6130165RC			
1.66	0.0654		6130166R	6130166RC			
1.67	0.0657		6130167R	6130167RC			
1.68	0.0661		6130168R	6130168RC			
1.69	0.0665		6130169R	6130169RC			
1.70	0.0669	51	6130170R	6130170RC			
1.71	0.0673		6130171R	6130171RC			
1.72	0.0677		6130172R	6130172RC			
1.73	0.0681		6130173R	6130173RC			
1.74	0.0685		6130174R	6130174RC			
1.75	0.0689		6130175R	6130175RC			
1.76	0.0693		6130176R	6130176RC			
1.77	0.0697		6130177R	6130177RC			
1.78	0.0701	50	6130178R	6130178RC			
1.79	0.0705		6130179R	6130179RC			
1.80	0.0709		6130180R	6130180RC			
1.81	0.0713		6130181R	6130181RC			
1.82	0.0717		6130182R	6130182RC			
1.83	0.0720		6130183R	6130183RC			
1.84	0.0724		6130184R	6130184RC			
1.85	0.0728	49	6130185R	6130185RC			
1.86	0.0732		6130186R	6130186RC			
1.87	0.0736		6130187R	6130187RC			
1.88	0.0740		6130188R	6130188RC			
1.89	0.0744		6130189R	6130189RC			
1.90	0.0748		6130190R	6130190RC			
1.91	0.0752		6130191R	6130191RC			
1.92	0.0756		6130192R	6130192RC			
1.93	0.0760	48	6130193R	6130193RC			
1.94	0.0764		6130194R	6130194RC			
1.95	0.0768		6130195R	6130195RC			
1.96	0.0772		6130196R	6130196RC			
1.97	0.0776		6130197R	6130197RC			
1.98	0.0780	5/64	6130198R	6130198RC			
1.99	0.0783	47	6130199R	6130199RC			

NOTE: For 2.00 to 3.00mm x 3mm Shank go to 6120 Series

6120 Series Solid Carbide

4-5 x D – Depth of Cut 120°



10% COBALT
MICRO
GRAIN
CARBIDE

RH

120°
Point

35°
Helix

2
FLUTES

HARDNESS
1570=
HV30

h6

+ 0.000/- 0.006mm (h6) Uncoated Version
+ 0.002/-0.004mm Coated Version

For medium to high tensile strength steel, stainless, titanium alloys and cast iron.

All items can be ordered as left hand at same pricing. Special, custom specification items available.

Custom specifications such as:

- Helix angle of 15°, 24°, 30° or other
- Point angles of 90°, 110°, 130°, 140° or other
- Special diameters as 1.255mm or other
- Special tolerances as +/- 0.001mm or other
- Coolant thru drills at 3 and 4mm shanks and 1.25 to 3mm flute diameters
- Coatings available upon request
- Minimum custom order is 10 Pieces / Spec.
- 4mm max for specials
- **Lead-time on custom orders—4 Weeks ARO**

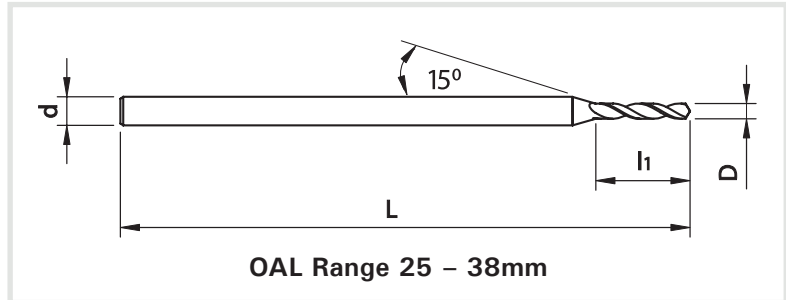

Non-stock: allow 4 weeks for delivery

6120 Series Solid Carbide - Drill Sizes 0.20 – 0.71mm
NOTE: Sold in 10 piece packages only

D Flute Dia. (mm)	Dec. Equiv. Flute Dia. (inch)	Wire # Frac	d Shank Dia. (mm)	l1 Flute Length (mm)	L Overall Length OAL (mm)	Uncoated (R) EDP No.	TiAlN Coated (RC) EDP No.				
0.20	0.0079	92	1.0	1.1	25.0	6120020R	-				
0.21	0.0083	91				6120021R	-				
0.22	0.0087	90				6120022R	-				
0.23	0.0091	89				6120023R	-				
0.24	0.0094	88				6120024R	-				
0.25	0.0098					6120025R	-				
0.26	0.0102					6120026R	-				
0.27	0.0106	86				6120027R	-				
0.28	0.0110	85				6120028R	-				
0.29	0.0114	84				6120029R	-				
0.30	0.0118			6120030R		-					
0.31	0.0122			6120031R		-					
0.32	0.0126	82		6120032R		-					
0.33	0.0130	81		6120033R		-					
0.34	0.0134	80		6120034R		-					
0.35	0.0138			6120035R		-					
0.36	0.0142			6120036R		-					
0.37	0.0146	79		6120037R		-					
0.38	0.0150			6120038R		-					
0.39	0.0154			6120039R		-					
0.40	0.0157			6120040R		-					
0.41	0.0161	78		6120041R		-					
0.42	0.0165			6120042R		-					
0.43	0.0169			6120043R		-					
0.44	0.0173			6120044R		-					
0.45	0.0177			6120045R		-					
				1.3		1.6					
				2.0		2.0					

6120 Series Solid Carbide - Drill Sizes 0.20 – 0.71mm

D Flute Dia. (mm)	Dec. Equiv. Flute Dia. (inch)	Wire # Frac	d Shank Dia. (mm)	l1 Flute Length (mm)	L Overall Length OAL (mm)	Uncoated (R) EDP No.	TiAlN Coated (RC) EDP No.
0.46	0.0181	77	1.0	2.0	25.0	6120046R	-
0.47	0.0185					6120047R	-
0.48	0.0189					6120048R	-
0.49	0.0193					6120049R	-
0.50	0.0197					6120050R	6120050RC
0.51	0.0201	76		2.4		6120051R	6120051RC
0.52	0.0205					6120052R	6120052RC
0.53	0.0209	75				6120053R	6120053RC
0.54	0.0213					6120054R	6120054RC
0.55	0.0217					6120055R	6120055RC
0.56	0.0220		2.8	6120056R	6120056RC		
0.57	0.0224	74		6120057R	6120057RC		
0.58	0.0228			6120058R	6120058RC		
0.59	0.0232			6120059R	6120059RC		
0.60	0.0236			1.5	2.8	6120060R	6120060RC
0.61	0.0240	73	6120061R			6120061RC	
0.62	0.0244		6120062R			6120062RC	
0.63	0.0248	72	6120063R			6120063RC	
0.64	0.0252		3.3			6120064R	6120064RC
0.65	0.0256				6120065R	6120065RC	
0.66	0.0260	71			6120066R	6120066RC	
0.67	0.0264				6120067R	6120067RC	
0.68	0.0268				3.8	6120068R	6120068RC
0.69	0.0272		6120069R			6120069RC	
0.70	0.0276		6120070R	6120070RC			
0.71	0.0280	70	6120071R	6120071RC			

Series 6120 Continued

***SPECIAL ORDERS:** Series 6120 flute diameters coated sizes smaller than 0.50mm are special order. Please contact Pilot Precision Products for details.

6120 Series Solid Carbide

4-5 x D – Depth of Cut 120°, continued



Non-stock: allow 4 weeks for delivery

6120 Series Solid Carbide - Drill Sizes 0.72 – 1.65mm							
NOTE: Sold in 10 piece packages only							
D Flute Dia. (mm)	D Dec. Equiv. Flute Dia. (inch)	Wire # Frac	d Shank Dia. (mm)	l1 Flute Length (mm)	L Overall Length OAL (mm)	Uncoated (R) EDP No.	TiAlN Coated (RC) EDP No.
0.72	0.0283		1.5	3.8	30.0	6120072R	6120072RC
0.73	0.0287					6120073R	6120073RC
0.74	0.0291	69				6120074R	6120074RC
0.75	0.0295					6120075R	6120075RC
0.76	0.0299					6120076R	6120076RC
0.77	0.0303					6120077R	6120077RC
0.78	0.0307			6120078R		6120078RC	
0.79	0.0311	68-1/32		6120079R		6120079RC	
0.80	0.0315			6120080R		6120080RC	
0.81	0.0319	67		6120081R		6120081RC	
0.82	0.0323			6120082R		6120082RC	
0.83	0.0327			6120083R		6120083RC	
0.84	0.0331	66		6120084R		6120084RC	
0.85	0.0335			6120085R		6120085RC	
0.86	0.0339			6120086R		6120086RC	
0.87	0.0343			6120087R		6120087RC	
0.88	0.0346			6120088R		6120088RC	
0.89	0.0350	65		6120089R		6120089RC	
0.90	0.0354		6120090R	6120090RC			
0.91	0.0358	64	6120091R	6120091RC			
0.92	0.0362		6120092R	6120092RC			
0.93	0.0366		6120093R	6120093RC			
0.94	0.0370	63	6120094R	6120094RC			
0.95	0.0374		6120095R	6120095RC			
0.96	0.0378	62	6120096R	6120096RC			
0.97	0.0382		6120097R	6120097RC			
0.98	0.0386		6120098R	6120098RC			
0.99	0.0390	61	6120099R	6120099RC			
1.00	0.0394		6120100R	6120100RC			
1.01	0.0398	60	6120101R	6120101RC			
1.02	0.0402		6120102R	6120102RC			
1.03	0.0406		6120103R	6120103RC			
1.04	0.0409	59	6120104R	6120104RC			
1.05	0.0413		6120105R	6120105RC			
1.06	0.0417		6120106R	6120106RC			
1.07	0.0421	58	6120107R	6120107RC			
1.08	0.0425		6120108R	6120108RC			
1.09	0.0429	57	6120109R	6120109RC			
1.10	0.0433		6120110R	6120110RC			
1.11	0.0437		6120111R	6120111RC			
1.12	0.0441		6120112R	6120112RC			
1.13	0.0445		6120113R	6120113RC			
1.14	0.0449		6120114R	6120114RC			
1.15	0.0453		6120115R	6120115RC			
1.16	0.0457		6120116R	6120116RC			
1.17	0.0461		6120117R	6120117RC			
1.18	0.0465	56	6120118R	6120118RC			

6120 Series Solid Carbide - Drill Sizes 0.72 – 1.65mm							
D Flute Dia. (mm)	D Dec. Equiv. Flute Dia. (inch)	Wire # Frac	d Shank Dia. (mm)	l1 Flute Length (mm)	L Overall Length OAL (mm)	Uncoated (R) EDP No.	TiAlN Coated (RC) EDP No.
1.19	0.0469	3/64	1.5	5.4	30.0	6120119R	6120119RC
1.20	0.0472			6120120R		6120120RC	
1.21	0.0476			6120121R		6120121RC	
1.22	0.0480			6120122R		6120122RC	
1.23	0.0484			6120123R		6120123RC	
1.24	0.0488			6120124R		6120124RC	
1.25	0.0492			6120125R		6120125RC	
1.26	0.0496			6120126R		6120126RC	
1.27	0.0500			6120127R		6120127RC	
1.28	0.0504			6120128R		6120128RC	
1.29	0.0508			6120129R		6120129RC	
1.30	0.0512			6120130R		6120130RC	
1.31	0.0516			6120131R		6120131RC	
1.32	0.0520	55		6120132R		6120132RC	
1.33	0.0524			6120133R		6120133RC	
1.34	0.0528			6120134R		6120134RC	
1.35	0.0531			6120135R		6120135RC	
1.36	0.0535			6120136R		6120136RC	
1.37	0.0539		6120137R	6120137RC			
1.38	0.0543		6120138R	6120138RC			
1.39	0.0547		6120139R	6120139RC			
1.40	0.0551	54	6120140R	6120140RC			
1.41	0.0555		6120141R	6120141RC			
1.42	0.0559		6120142R	6120142RC			
1.43	0.0563		6120143R	6120143RC			
1.44	0.0567		6120144R	6120144RC			
1.45	0.0571		6120145R	6120145RC			
1.46	0.0575		6120146R	6120146RC			
1.47	0.0579		6120147R	6120147RC			
1.48	0.0583		6120148R	6120148RC			
1.49	0.0587		6120149R	6120149RC			
1.50	0.0591		6120150R	6120150RC			
1.51	0.0594	53	6120151R	6120151RC			
1.52	0.0598		6120152R	6120152RC			
1.53	0.0602		6120153R	6120153RC			
1.54	0.0606		6120154R	6120154RC			
1.55	0.0610		6120155R	6120155RC			
1.56	0.0614		6120156R	6120156RC			
1.57	0.0618		6120157R	6120157RC			
1.58	0.0622		6120158R	6120158RC			
1.59	0.0626	1/16	6120159R	6120159RC			
1.60	0.0630		6120160R	6120160RC			
1.61	0.0634	52	6120161R	6120161RC			
1.62	0.0638		6120162R	6120162RC			
1.63	0.0642		6120163R	6120163RC			
1.64	0.0646		6120164R	6120164RC			
1.65	0.0650		6120165R	6120165RC			

Series 6120 Continued

6120 Series Solid Carbide

4-5 x D – Depth of Cut 120°, continued



Non-stock: allow 4 weeks for delivery

6120 Series Solid Carbide - Drill Sizes 1.66 – 2.59mm								
NOTE: Sold in 10 piece packages only								
D Flute Dia. (mm)	D Dec. Equiv. Flute Dia. (inch)	Wire #	d Shank Dia. (mm)	I1 Flute Length (mm)	L Overall Length OAL (mm)	Uncoated (R) EDP No.	TiAlN Coated (RC) EDP No.	
1.66	0.0654		7.2	7.2	38.0	6120166R	6120166RC	
1.67	0.0657					6120167R	6120167RC	
1.68	0.0661					6120168R	6120168RC	
1.69	0.0665					6120169R	6120169RC	
1.70	0.0669	51				6120170R	6120170RC	
1.71	0.0673					6120171R	6120171RC	
1.72	0.0677					6120172R	6120172RC	
1.73	0.0681					6120173R	6120173RC	
1.74	0.0685					6120174R	6120174RC	
1.75	0.0689					6120175R	6120175RC	
1.76	0.0693					6120176R	6120176RC	
1.77	0.0697					6120177R	6120177RC	
1.78	0.0701	50				6120178R	6120178RC	
1.79	0.0705					6120179R	6120179RC	
1.80	0.0709					6120180R	6120180RC	
1.81	0.0713					6120181R	6120181RC	
1.82	0.0717					6120182R	6120182RC	
1.83	0.0720					6120183R	6120183RC	
1.84	0.0724		6120184R	6120184RC				
1.85	0.0728	49	6120185R	6120185RC				
1.86	0.0732		6120186R	6120186RC				
1.87	0.0736		6120187R	6120187RC				
1.88	0.0740		6120188R	6120188RC				
1.89	0.0744		6120189R	6120189RC				
1.90	0.0748		6120190R	6120190RC				
1.91	0.0752		6120191R	6120191RC				
1.92	0.0756		6120192R	6120192RC				
1.93	0.0760	48	6120193R	6120193RC				
1.94	0.0764		6120194R	6120194RC				
1.95	0.0768		6120195R	6120195RC				
1.96	0.0772		6120196R	6120196RC				
1.97	0.0776		6120197R	6120197RC				
1.98	0.0780	5/64	6120198R	6120198RC				
1.99	0.0783	47	6120199R	6120199RC				
2.00	0.0787		6120200R	6120200RC				
2.01	0.0791		6120201R	6120201RC				
2.02	0.0795		6120202R	6120202RC				
2.03	0.0799		6120203R	6120203RC				
2.04	0.0803		6120204R	6120204RC				
2.05	0.0807		6120205R	6120205RC				
2.06	0.0811	46	6120206R	6120206RC				
2.07	0.0815		6120207R	6120207RC				
2.08	0.0819	45	6120208R	6120208RC				
2.09	0.0823		6120209R	6120209RC				
2.10	0.0827		6120210R	6120210RC				
2.11	0.0831		6120211R	6120211RC				
2.12	0.0835		6120212R	6120212RC				

6120 Series Solid Carbide - Drill Sizes 1.66 – 2.59mm								
D Flute Dia. (mm)	D Dec. Equiv. Flute Dia. (inch)	Wire #	d Shank Dia. (mm)	I1 Flute Length (mm)	L Overall Length OAL (mm)	Uncoated (R) EDP No.	TiAlN Coated (RC) EDP No.	
2.13	0.0839		12.0	12.0	38.0	6120213R	6120213RC	
2.14	0.0843					6120214R	6120214RC	
2.15	0.0846					6120215R	6120215RC	
2.16	0.0850					6120216R	6120216RC	
2.17	0.0854					6120217R	6120217RC	
2.18	0.0858	44				6120218R	6120218RC	
2.19	0.0862					6120219R	6120219RC	
2.20	0.0866					6120220R	6120220RC	
2.21	0.0870					6120221R	6120221RC	
2.22	0.0874					6120222R	6120222RC	
2.23	0.0878					6120223R	6120223RC	
2.24	0.0882					6120224R	6120224RC	
2.25	0.0886					6120225R	6120225RC	
2.26	0.0890	43				6120226R	6120226RC	
2.27	0.0894					6120227R	6120227RC	
2.28	0.0898					6120228R	6120228RC	
2.29	0.0902					6120229R	6120229RC	
2.30	0.0906					6120230R	6120230RC	
2.31	0.0909		6120231R	6120231RC				
2.32	0.0913		6120232R	6120232RC				
2.33	0.0917		6120233R	6120233RC				
2.34	0.0921		6120234R	6120234RC				
2.35	0.0925		6120235R	6120235RC				
2.36	0.0929		6120236R	6120236RC				
2.37	0.0933		6120237R	6120237RC				
2.38	0.0937	3/32	6120238R	6120238RC				
2.39	0.0941		6120239R	6120239RC				
2.40	0.0945		6120240R	6120240RC				
2.41	0.0949		6120241R	6120241RC				
2.42	0.0953		6120242R	6120242RC				
2.43	0.0957		6120243R	6120243RC				
2.44	0.0961	41	6120244R	6120244RC				
2.45	0.0965		6120245R	6120245RC				
2.46	0.0969		6120246R	6120246RC				
2.47	0.0972		6120247R	6120247RC				
2.48	0.0976		6120248R	6120248RC				
2.49	0.0980	40	6120249R	6120249RC				
2.50	0.0984		6120250R	6120250RC				
2.51	0.0988		6120251R	6120251RC				
2.52	0.0992		6120252R	6120252RC				
2.53	0.0996	39	6120253R	6120253RC				
2.54	0.1000		6120254R	6120254RC				
2.55	0.1004		6120255R	6120255RC				
2.56	0.1008		6120256R	6120256RC				
2.57	0.1012		6120257R	6120257RC				
2.58	0.1016	38	6120258R	6120258RC				
2.59	0.1020		6120259R	6120259RC				

Series 6120 Continued

6120 Series Solid Carbide

4-5x D – Depth of Cut 120°, continued



Non-stock: allow 4 weeks for delivery

6120 Series Solid Carbide - Drill Sizes 2.60 – 3.00mm

NOTE: Sold in 10 piece packages only

D Flute Dia. (mm)	D Dec. Equiv. Flute Dia. (inch)	Wire # Frac	d Shank Dia. (mm)	l1 Flute Length (mm)	L Overall Length OAL (mm)	Uncoated (R) EDP No.	TiAlN Coated (RC) EDP No.
2.60	0.1024		3.0	14.0	38.0	6120260R	6120260RC
2.61	0.1028					6120261R	6120261RC
2.62	0.1031					6120262R	6120262RC
2.63	0.1035					6120263R	6120263RC
2.64	0.1039	37				6120264R	6120264RC
2.65	0.1043					6120265R	6120265RC
2.66	0.1047					6120266R	6120266RC
2.67	0.1051					6120267R	6120267RC
2.68	0.1055					6120268R	6120268RC
2.69	0.1059					6120269R	6120269RC
2.70	0.1063	36				6120270R	6120270RC
2.71	0.1067					6120271R	6120271RC
2.72	0.1071					6120272R	6120272RC
2.73	0.1075					6120273R	6120273RC
2.74	0.1079					6120274R	6120274RC
2.75	0.1083					6120275R	6120275RC
2.76	0.1087					6120276R	6120276RC
2.77	0.1091					6120277R	6120277RC
2.78	0.1094	7/64				6120278R	6120278RC
2.79	0.1098	35				6120279R	6120279RC
2.80	0.1102		6120280R	6120280RC			

6120 Series Solid Carbide - Drill Sizes 2.60 – 3.00mm

D Flute Dia. (mm)	D Dec. Equiv. Flute Dia. (inch)	Wire # Frac	d Shank Dia. (mm)	l1 Flute Length (mm)	L Overall Length OAL (mm)	Uncoated (R) EDP No.	TiAlN Coated (RC) EDP No.
2.81	0.1106		3.0	14.0	38.0	6120281R	6120281RC
2.82	0.1110	34				6120282R	6120282RC
2.83	0.1114					6120283R	6120283RC
2.84	0.1118					6120284R	6120284RC
2.85	0.1122					6120285R	6120285RC
2.86	0.1126					6120286R	6120286RC
2.87	0.1130	33				6120287R	6120287RC
2.88	0.1134					6120288R	6120288RC
2.89	0.1138					6120289R	6120289RC
2.90	0.1142					6120290R	6120290RC
2.91	0.1146					6120291R	6120291RC
2.92	0.1150					6120292R	6120292RC
2.93	0.1154					6120293R	6120293RC
2.94	0.1157					6120294R	6120294RC
2.95	0.1161	32				6120295R	6120295RC
2.96	0.1165					6120296R	6120296RC
2.97	0.1169					6120297R	6120297RC
2.98	0.1173					6120298R	6120298RC
2.99	0.1177					6120299R	6120299RC
3.00	0.1181					6120300R	6120300RC

6100 Series Solid Carbide

5-7 x D – Depth of Cut 120°



10% COBALT
MICRO
GRAIN
CARBIDE

RH

120°
Point

35°
Helix

2
FLUTES

HARDNESS
1570=HV30

h6

+ 0.000/- 0.006mm (h6) Uncoated Version
+ 0.002/-0.004mm Coated Version

For medium to high tensile strength steel, stainless, titanium alloys and cast iron.
All items can be ordered as left hand at same pricing. Special, custom specification items available.

Custom specifications such as:

- Helix angle of 15°, 24°, 30° or other
- Point angles of 90°, 110°, 130°, 140° or other
- Special diameters as 1.255mm or other
- Special tolerances as +/- 0.001mm or other
- Coolant thru drills at 3 and 4mm shanks
- **Special sizes up to 4mm**
- Minimum custom order is 10 Pieces / Spec.
- **Lead-time on custom orders—4 Weeks ARO**

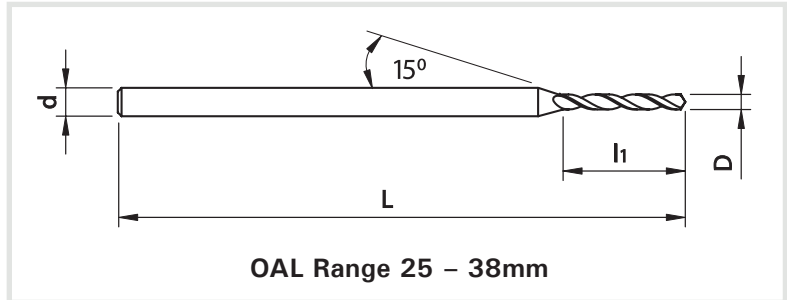

OAL Range 25 – 38mm

 Non-stock: allow 4 weeks for delivery

6100 Series Solid Carbide - Drill Sizes 0.10 – 0.61mm
NOTE: Sold in 10 piece packages only

D Flute Dia. (mm)	D Dec. Equiv. Flute Dia. (inch)	Wire # Frac	d Shank Dia. (mm)	l1 Flute Fength (mm)	L Overall Length OAL (mm)	Uncoated (R) EDP No.	TiAlN Coated (RC) EDP No.
0.10	0.0039		1.0	0.5	25.0	6100010R	-
0.11	0.0043					6100011R	-
0.12	0.0047					6100012R	-
0.13	0.0051			6100013R		-	
0.14	0.0055			6100014R		-	
0.15	0.0059	97		6100015R		-	
0.16	0.0063	96		6100016R		-	
0.17	0.0067	95		6100017R		-	
0.18	0.0071	94		6100018R		-	
0.19	0.0075	93		6100019R		-	
0.20	0.0079	92	6100020R	-			
0.21	0.0083	91	1.8	25.0	6100021R	-	
0.22	0.0087	90			6100022R	-	
0.23	0.0091	89			6100023R	-	
0.24	0.0094	88			6100024R	-	
0.25	0.0098				6100025R	-	
0.26	0.0102				6100026R	-	
0.27	0.0106	86			6100027R	-	
0.28	0.0110	85			6100028R	-	
0.29	0.0114	84			6100029R	-	
0.30	0.0118				6100030R	-	
0.31	0.0122		2.2	25.0	6100031R	-	
0.32	0.0126	82			6100032R	-	
0.33	0.0130	81			6100033R	-	
0.34	0.0134	80			6100034R	-	
0.35	0.0138				6100035R	-	

6100 Series Solid Carbide - Drill Sizes 0.10 – 0.61mm

D Flute Dia. (mm)	D Dec. Equiv. Flute Dia. (inch)	Wire # Frac	d Shank Dia. (mm)	l1 Flute Length (mm)	L Overall Length OAL (mm)	Uncoated (R) EDP No.	TiAlN Coated (RC) EDP No.
0.36	0.0142		1.0	2.8	25.0	6100036R	-
0.37	0.0146	79				6100037R	-
0.38	0.0150					6100038R	-
0.39	0.0154					6100039R	-
0.40	0.0157					6100040R	-
0.41	0.0161	78		6100041R		-	
0.42	0.0165			6100042R		-	
0.43	0.0169			6100043R		-	
0.44	0.0173			6100044R		-	
0.45	0.0177			6100045R		-	
0.46	0.0181	77	6100046R	-			
0.47	0.0185		4.0	25.0	6100047R	-	
0.48	0.0189				6100048R	-	
0.49	0.0193				6100049R	-	
0.50	0.0197				6100050R	6100050RC	
0.51	0.0201	76			6100051R	6100051RC	
0.52	0.0205				6100052R	6100052RC	
0.53	0.0209	75			6100053R	6100053RC	
0.54	0.0213				6100054R	6100054RC	
0.55	0.0217				6100055R	6100055RC	
0.56	0.0220				6100056R	6100056RC	
0.57	0.0224	74	4.5	25.0	6100057R	6100057RC	
0.58	0.0228				6100058R	6100058RC	
0.59	0.0232				6100059R	6100059RC	
0.60	0.0236				6100060R	6100060RC	
0.61	0.0240	73			6100061R	6100061RC	

Series 6100 Continued

***SPECIAL ORDERS:** Series 6100 flute diameters coated sizes smaller than 0.50mm are special order.
Please contact Pilot Precision Products for details.

6100 Series Solid Carbide

5-7 x D – Depth of Cut 120°, continued



Non-stock: allow 4 weeks for delivery

6100 Series Solid Carbide - Drill Sizes 0.62 – 1.53mm							
NOTE: Sold in 10 piece packages only							
D Flute Dia. (mm)	D Dec. Equiv. Flute Dia. (inch)	Wire # Frac	d Shank Dia. (mm)	l1 Flute Length (mm)	L Overall Length OAL (mm)	Uncoated (R) EDP No.	TiAlN Coated (RC) EDP No.
0.62	0.0244		1.5	5.0	30.0	6100062R	6100062RC
0.63	0.0248	72				6100063R	6100063RC
0.64	0.0252					6100064R	6100064RC
0.65	0.0256					6100065R	6100065RC
0.66	0.0260	71				6100066R	6100066RC
0.67	0.0264			6100067R		6100067RC	
0.68	0.0268			6100068R		6100068RC	
0.69	0.0272			6100069R		6100069RC	
0.70	0.0276			6100070R		6100070RC	
0.71	0.0280	70		6100071R		6100071RC	
0.72	0.0283		5.6	30.0	6100072R	6100072RC	
0.73	0.0287				6100073R	6100073RC	
0.74	0.0291	69			6100074R	6100074RC	
0.75	0.0295				6100075R	6100075RC	
0.76	0.0299				6100076R	6100076RC	
0.77	0.0303		6100077R		6100077RC		
0.78	0.0307		6100078R		6100078RC		
0.79	0.0311	68-1/32	6.3		30.0	6100079R	6100079RC
0.80	0.0315					6100080R	6100080RC
0.81	0.0319	67				6100081R	6100081RC
0.82	0.0323			6100082R		6100082RC	
0.83	0.0327			6100083R		6100083RC	
0.84	0.0331	66	6100084R	6100084RC			
0.85	0.0335		6100085R	6100085RC			
0.86	0.0339		6100086R	6100086RC			
0.87	0.0343		6100087R	6100087RC			
0.88	0.0346		6100088R	6100088RC			
0.89	0.0350	65	7.1	30.0	6100089R	6100089RC	
0.90	0.0354				6100090R	6100090RC	
0.91	0.0358	64			6100091R	6100091RC	
0.92	0.0362				6100092R	6100092RC	
0.93	0.0366				6100093R	6100093RC	
0.94	0.0370	63	6100094R		6100094RC		
0.95	0.0374		6100095R		6100095RC		
0.96	0.0378	62	8.0		30.0	6100096R	6100096RC
0.97	0.0382					6100097R	6100097RC
0.98	0.0386					6100098R	6100098RC
0.99	0.0390	61		6100099R		6100099RC	
1.00	0.0394			6100100R		6100100RC	
1.01	0.0398	60	6100101R	6100101RC			
1.02	0.0402		6100102R	6100102RC			
1.03	0.0406		6100103R	6100103RC			
1.04	0.0409	59	6100104R	6100104RC			
1.05	0.0413		6100105R	6100105RC			
1.06	0.0417		9.0	30.0	6100106R	6100106RC	
1.07	0.0421	58			6100107R	6100107RC	

6100 Series Solid Carbide - Drill Sizes 0.62 – 1.53mm								
D Flute Dia. (mm)	D Dec. Equiv. Flute Dia. (inch)	Wire # Frac	d Shank Dia. (mm)	l1 Flute Length (mm)	L Overall Length OAL (mm)	Uncoated (R) EDP No.	TiAlN Coated (RC) EDP No.	
1.08	0.0425		1.5	9.0	30.0	6100108R	6100108RC	
1.09	0.0429	57				6100109R	6100109RC	
1.10	0.0433					6100110R	6100110RC	
1.11	0.0437					6100111R	6100111RC	
1.12	0.0441					6100112R	6100112RC	
1.13	0.0445			10.0		30.0	6100113R	6100113RC
1.14	0.0449						6100114R	6100114RC
1.15	0.0453						6100115R	6100115RC
1.16	0.0457						6100116R	6100116RC
1.17	0.0461						6100117R	6100117RC
1.18	0.0465	56	11.2	30.0	6100118R		6100118RC	
1.19	0.0469	3/64			6100119R		6100119RC	
1.20	0.0472				6100120R		6100120RC	
1.21	0.0476				6100121R		6100121RC	
1.22	0.0480				6100122R		6100122RC	
1.23	0.0484		11.2		30.0	6100123R	6100123RC	
1.24	0.0488					6100124R	6100124RC	
1.25	0.0492					6100125R	6100125RC	
1.26	0.0496					6100126R	6100126RC	
1.27	0.0500					6100127R	6100127RC	
1.28	0.0504		2.0	38.0		6100128R	6100128RC	
1.29	0.0508					6100129R	6100129RC	
1.30	0.0512					6100130R	6100130RC	
1.31	0.0516					6100131R	6100131RC	
1.32	0.0520	55				6100132R	6100132RC	
1.33	0.0524		11.2		38.0	6100133R	6100133RC	
1.34	0.0528					6100134R	6100134RC	
1.35	0.0531					6100135R	6100135RC	
1.36	0.0535					6100136R	6100136RC	
1.37	0.0539					6100137R	6100137RC	
1.38	0.0543		11.2	38.0		6100138R	6100138RC	
1.39	0.0547					6100139R	6100139RC	
1.40	0.0551	54				6100140R	6100140RC	
1.41	0.0555					6100141R	6100141RC	
1.42	0.0559					6100142R	6100142RC	
1.43	0.0563		11.2		38.0	6100143R	6100143RC	
1.44	0.0567					6100144R	6100144RC	
1.45	0.0571					6100145R	6100145RC	
1.46	0.0575					6100146R	6100146RC	
1.47	0.0579					6100147R	6100147RC	
1.48	0.0583		11.2	38.0		6100148R	6100148RC	
1.49	0.0587					6100149R	6100149RC	
1.50	0.0591					6100150R	6100150RC	
1.51	0.0594	53				6100151R	6100151RC	
1.52	0.0598					6100152R	6100152RC	
1.53	0.0602		6100153R		6100153RC			

Series 6100 Continued

6100 Series Solid Carbide

5-7 x D – Depth of Cut 120°, continued



Non-stock: allow 4 weeks for delivery

6100 Series Solid Carbide - Drill Sizes 1.54 – 1.99mm
NOTE: Sold in 10 piece packages only

D Flute Dia. (mm)	D Dec. Equiv. Flute Dia. (inch)	Wire # Frac	d Shank Dia. (mm)	l1 Flute Length (mm)	L Overall Length OAL (mm)	Uncoated (R) EDP No.	TiAlN Coated (RC) EDP No.
1.54	0.0606		2.0	12.0	38.0	6100154R	6100154RC
1.55	0.0610					6100155R	6100155RC
1.56	0.0614					6100156R	6100156RC
1.57	0.0618					6100157R	6100157RC
1.58	0.0622					6100158R	6100158RC
1.59	0.0626	1/16				6100159R	6100159RC
1.60	0.0630					6100160R	6100160RC
1.61	0.0634	52				6100161R	6100161RC
1.62	0.0638					6100162R	6100162RC
1.63	0.0642					6100163R	6100163RC
1.64	0.0646					6100164R	6100164RC
1.65	0.0650					6100165R	6100165RC
1.66	0.0654					6100166R	6100166RC
1.67	0.0657					6100167R	6100167RC
1.68	0.0661					6100168R	6100168RC
1.69	0.0665					6100169R	6100169RC
1.70	0.0669	51				6100170R	6100170RC
1.71	0.0673					6100171R	6100171RC
1.72	0.0677					6100172R	6100172RC
1.73	0.0681					6100173R	6100173RC
1.74	0.0685		6100174R	6100174RC			
1.75	0.0689		6100175R	6100175RC			
1.76	0.0693		6100176R	6100176RC			

6100 Series Solid Carbide - Drill Sizes 1.54 – 1.99mm

D Flute Dia. (mm)	D Dec. Equiv. Flute Dia. (inch)	Wire # Frac	d Shank Dia. (mm)	l1 Flute Length (mm)	L Overall Length OAL (mm)	Uncoated (R) EDP No.	TiAlN Coated (RC) EDP No.
1.77	0.0697		2.0	12.0	38.0	6100177R	6100177RC
1.78	0.0701	50				6100178R	6100178RC
1.79	0.0705					6100179R	6100179RC
1.80	0.0709					6100180R	6100180RC
1.81	0.0713					6100181R	6100181RC
1.82	0.0717					6100182R	6100182RC
1.83	0.0720					6100183R	6100183RC
1.84	0.0724					6100184R	6100184RC
1.85	0.0728	49				6100185R	6100185RC
1.86	0.0732					6100186R	6100186RC
1.87	0.0736					6100187R	6100187RC
1.88	0.0740					6100188R	6100188RC
1.89	0.0744					6100189R	6100189RC
1.90	0.0748					6100190R	6100190RC
1.91	0.0752					6100191R	6100191RC
1.92	0.0756					6100192R	6100192RC
1.93	0.0760	48				6100193R	6100193RC
1.94	0.0764					6100194R	6100194RC
1.95	0.0768					6100195R	6100195RC
1.96	0.0772					6100196R	6100196RC
1.97	0.0776		6100197R	6100197RC			
1.98	0.0780	5/64	6100198R	6100198RC			
1.99	0.0783	47	6100199R	6100199RC			

NOTE: For drill sizes 2.00mm and larger See our 6120 and 6200 Series

6100 Series Solid Carbide

- For medium to high tensile strength Steel, Stainless, Titanium Alloys and Cast Iron
- Amazing dimension control at h6, h4 & h3 μm tolerances
- Ultra-fine surface finish for smooth operation
- Micro Grain Carbide with 10% Cobalt Content for outstanding performance & long tool life
- Coatings available upon request

1100 Series Solid Carbide Half Round Gun Drills

10 x D – Depth of Cut 120°



Direct drilling, no centering required, good chip evacuation, high performance in brass connectors.
 For soft materials, brass, copper, gold, silver and stainless, titanium alloys.
 Single lip half round for outstanding coolant flow and fine surface finishes.
 All items can be ordered as left hand cut at same pricing.
 Special, custom specification items available.

Custom specifications such as:

- Size range from 0.5mm to 2.00mm in increments of 0.05mm
- Intermediate sizes upon request
- Special sizes, point angles and tolerances available
- Minimum custom order is 10 Pieces
- **Lead-time on customs 4 weeks ARO**
6 weeks with coating

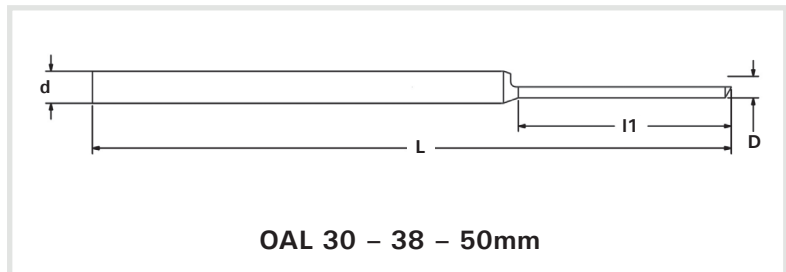

1100 Series Solid Carbide Half Round Gun Drills- Drill Sizes 0.20 – 3.00mm <i>NOTE: Sold in 10 piece packages only</i>						
D Flute Dia. (mm)	D Dec. Equiv. Flute Dia. (inch)	Wire # Frac	d Shank Dia. (mm)	l1 Flute Length (mm)	L Overall Length OAL (mm)	Uncoated (R) EDP No.
0.20	0.0079		1.50	2.00	30.0	1100020R
0.25	0.0098			2.50		1100025R
0.30	0.0118			3.00		1100030R
0.35	0.0138			3.50		1100035R
0.40	0.0157			4.00		1100040R
0.45	0.0177			4.50		1100045R
0.50	0.0197			5.00		1100050R
0.55	0.0217			5.50		1100055R
0.60	0.0236			6.00		1100060R
0.65	0.0256			6.50		1100065R
0.70	0.0276			7.00		1100070R
0.75	0.0295			7.50		1100075R
0.80	0.0315			8.00		1100080R
0.85	0.0335			8.50		1100085R
0.90	0.0354			9.00		1100090R
0.95	0.0374			9.50		1100095R
1.00	0.0394			10.00		1100100R
1.05	0.0413			11.50		1100105R
1.10	0.0433		11.00	1100110R		
1.15	0.0453		11.50	1100115R		
1.20	0.0472		12.00	1100120R		
1.25	0.0492		12.50	1100125R		
1.30	0.0512		13.00	1100130R		
1.35	0.0531		13.50	1100135R		

1100 Series Solid Carbide Half Round Gun Drills- Drill Sizes 0.20 – 3.00mm						
D Flute Dia. (mm)	D Dec. Equiv. Flute Dia. (inch)	Wire # Frac	d Shank Dia. (mm)	l1 Flute Length (mm)	L Overall Length OAL (mm)	Uncoated (R) EDP No.
1.40	0.0551	54	1.5	14.00	30.0	1100140R
1.45	0.0571			14.50		1100145R
1.50	0.0591		2.0	15.00	38.0	1100150R
1.55	0.0610			15.50		1100155R
1.60	0.0630			16.00		1100160R
1.65	0.0650			16.50		1100165R
1.70	0.0669	51		17.00		1100170R
1.75	0.0689			17.50		1100175R
1.80	0.0709			18.00		1100180R
1.85	0.0728	49		18.50		1100185R
1.90	0.0748			19.00		1100190R
1.95	0.0768			19.50		1100195R
2.00	0.0787		3.0	20.00	50.0	1100200R
2.10	0.0827			21.00		1100210R
2.20	0.0866			22.00		1100220R
2.30	0.0906			23.00		1100230R
2.40	0.0945			24.00		1100240R
2.50	0.0984			25.00		1100250R
2.60	0.1024			26.00		1100260R
2.70	0.1063	36		27.00		1100270R
2.80	0.1102			28.00		1100280R
2.90	0.1142			29.00		1100290R
3.00	0.1181		30.00	1100300R		

6200 HP Series Solid Carbide

6-7 x D – Depth of Cut 140°



h4 Tolerance Reinforced Shank d 3.0mm

10% COBALT
MICRO
GRAIN
CARBIDE

RH

140°
Point

30°
Helix

2
FLUTES

HARDNESS
1570=
HV30

h4

+ 0.000/- 0.004mm (h4) Uncoated Version
+ 0.002/-0.002mm Coated Version

High performance drill with a wide range of applications: steels, cast iron, and non-ferrous metals. Spot/center drill recommended for better hole straightness - with 6140 series. High performance with outstanding surface finishes with strong core - no deviation. All items can be quoted as left hand cut - contact us. Special, custom specification items available.

Custom specifications such as:

- Helix angle of 15°, 24°, 35° or other
- Point angles of 90°, 110°, 120°, 130° or other
- Special diameters as 0.92mm or other
- Special tolerances as +/- 0.001mm or other
- Minimum custom order is 10 Pieces
- **Lead-time on custom orders—4 Weeks ARO**

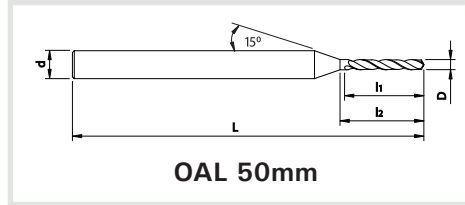

6200 HP Series Solid Carbide - Drill Sizes 0.50 – 4.00mm
NOTE: Sold in 5 piece packages only

D Flute Dia. (mm)	D Dec. Equiv. Flute Dia. (inch)	Wire # Frac	d Shank Dia. (mm)	I1 Flute Length (mm)	I2 D Length (mm)	L Overall Length OAL (mm)	Uncoated (R) EDP No.	TiAlN Coated (RC) EDP No.
0.50	0.0197		3.0	3.5	4.4	50.0	6200050R	6200050RC
0.55	0.0217			4.0	5.0		6200055R	6200055RC
0.60	0.0236			4.5	5.6		6200060R	6200060RC
0.65	0.0256			5.0	6.3		6200065R	6200065RC
0.70	0.0276			5.5	6.9		6200070R	6200070RC
0.75	0.0295			5.6	7.2		6200075R	6200075RC
0.80	0.0315			6.0	7.6		6200080R	6200080RC
0.85	0.0335			6.5	8.1		6200085R	6200085RC
0.90	0.0354			6.7	8.5		6200090R	6200090RC
0.95	0.0374			7.0	8.8		6200095R	6200095RC
1.00	0.0394			7.5	9.4		6200100R	6200100RC
1.05	0.0413			8.0	1.1		6200105R	6200105RC
1.10	0.0433			8.1	1.4		6200110R	6200110RC
1.15	0.0453			8.5	11.0		6200115R	6200115RC
1.20	0.0472			8.9	11.3		6200120R	6200120RC
1.25	0.0492			9.2	11.7		6200125R	6200125RC
1.30	0.0512			9.6	12.2		6200130R	6200130RC
1.35	0.0531		10.0	12.5	6200135R	6200135RC		
1.40	0.0551	54	10.0	12.5	6200140R	6200140RC		
1.45	0.0571		11.5	13.0	6200145R	6200145RC		
1.50	0.0591		11.0	13.5	6200150R	6200150RC		
1.55	0.0610		11.5	14.0	6200155R	6200155RC		
1.60	0.0630		12.0	15.0	6200160R	6200160RC		
1.65	0.0650		12.0	15.0	6200165R	6200165RC		
1.70	0.0669	51	12.0	15.0	6200170R	6200170RC		
1.75	0.0689		12.5	15.5	6200175R	6200175RC		

6200 HP Series Solid Carbide - Drill Sizes 0.50 – 4.00mm

D Flute Dia. (mm)	D Dec. Equiv. Flute Dia. (inch)	Wire # Frac	d Shank Dia. (mm)	I1 Flute Length (mm)	I2 D Length (mm)	L Overall Length OAL (mm)	Uncoated (R) EDP No.	TiAlN Coated (RC) EDP No.
1.80	0.0709		3.0	13.0	16.0	50.0	6200180R	6200180RC
1.85	0.0728	49		13.5	17.5		6200185R	6200185RC
1.90	0.0748			14.0	18.0		6200190R	6200190RC
1.95	0.0768			14.5	18.5		6200195R	6200195RC
2.00	0.0787			15.0	19.0		6200200R	6200200RC
2.05	0.0807			15.5	19.5		6200205R	6200205RC
2.10	0.0827			16.0	20.0		6200210R	6200210RC
2.15	0.0846			16.5	21.0		6200215R	6200215RC
2.20	0.0866			17.0	22.0		6200220R	6200220RC
2.25	0.0886			17.5	22.5		6200225R	6200225RC
2.30	0.0906			18.0	23.0		6200230R	6200230RC
2.35	0.0925			18.5	23.5		6200235R	6200235RC
2.40	0.0945			19.0	24.0		6200240R	6200240RC
2.45	0.0965			19.5	24.5		6200245R	6200245RC
2.50	0.0984			20.0	25.0		6200250R	6200250RC
2.55	0.1004			20.5	25.5		6200255R	6200255RC
2.60	0.1024			21.0	26.0		6200260R	6200260RC
2.65	0.1043		21.5	26.0	6200265R	6200265RC		
2.70	0.1063	36	22.0	27.0	6200270R	6200270RC		
2.75	0.1083		22.5	27.5	6200275R	6200275RC		
2.80	0.1102		23.0	27.5	6200280R	6200280RC		
2.85	0.1122		23.5	28.5	6200285R	6200285RC		
2.90	0.1142		24.0	29.0	6200290R	6200290RC		
2.95	0.1161	32	24.5	29.5	6200295R	6200295RC		
3.00	0.1181		25.0	30.0	6200300R	6200300RC		
3.10	0.1220		25.5	31.0	6200310R	6200310RC		
3.20	0.1260		26.0	32.0	6200320R	6200320RC		
3.30	0.1299		26.5	33.0	6200330R	6200330RC		
3.40	0.1339		27.0	33.0	6200340R	6200340RC		
3.50	0.1378		27.5	34.0	6200350R	6200350RC		
3.60	0.1417		28.0	35.0	6200360R	6200360RC		
3.70	0.1457		28.5	36.0	6200370R	6200370RC		
3.80	0.1496		29.0	37.0	6200380R	6200380RC		
3.90	0.1535		29.5	38.0	6200390R	6200390RC		
4.00	0.1575		30.0	39.0	6200400R	6200400RC		

New for 2022

6220 HP Series Solid Carbide

12 x D – Depth of Cut 140°



h5 Tolerance Reinforced Shank d 3.0mm



+ 0.000/- 0.005mm (h5) Uncoated Version
 + 0.002/-0.003mm Coated Version

High performance drill with reinforced shank at 3.00mm.
 Spot/center drill recommended for better hole straightness - with 6140 series.
 For soft, medium and tensile strength steels, stainless, titanium, alloys and cast iron.
 High performance with outstanding surface finishes with strong core - no deviation.
 All items can be quoted as left hand cut - contact us.

Custom specifications such as:

- Size range from 0.20mm to 3.00mm in increments of 0.05mm
- Intermediate sizes upon request
- Special sizes and tolerances available
- Special sizes up to 4mm**
- Minimum custom order is 10 Pieces
- Lead-time on custom orders—4 Weeks ARO**

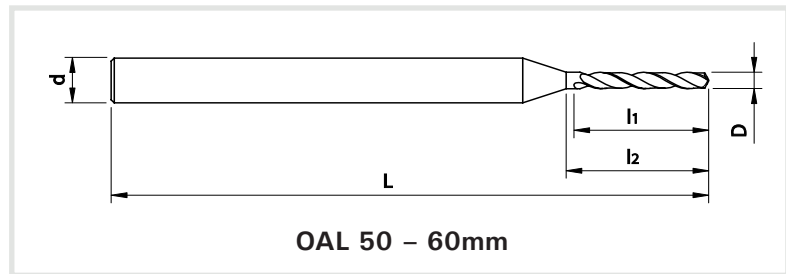

6220 HP Series Solid Carbide - Drill Sizes 0.50 – 3.00mm

NOTE: Sold in 5 piece packages only

D Flute Dia. (mm)	D Dec. Equiv. Flute Dia. (inch)	Wire # Frac	d Shank Dia. (mm)	l1 Flute Length (mm)	l2 D Length (mm)	L Overall Length OAL (mm)	Uncoated (R) EDP No.	TiAIN Coated (RC) EDP No.
0.50	0.0197		3.0	6.0	7.2	50.0	6220050R	6220050RC
0.55	0.0217			6.6	7.9		6220055R	6220055RC
0.60	0.0236			7.2	8.6		6220060R	6220060RC
0.65	0.0256			7.8	9.4		6220065R	6220065RC
0.70	0.0276			8.4	1.1		6220070R	6220070RC
0.75	0.0295			9.0	1.8		6220075R	6220075RC
0.80	0.0315			9.6	11.5		6220080R	6220080RC
0.85	0.0335			1.2	12.2		6220085R	6220085RC
0.90	0.0354			1.8	13.0		6220090R	6220090RC
0.95	0.0374			11.4	13.7		6220095R	6220095RC
1.00	0.0394			12.0	14.4		6220100R	6220100RC
1.05	0.0413			12.6	15.1		6220105R	6220105RC
1.10	0.0433			13.2	15.8		6220110R	6220110RC
1.15	0.0453			13.8	16.6		6220115R	6220115RC
1.20	0.0472			14.4	17.3		6220120R	6220120RC
1.25	0.0492			15.0	18.0		6220125R	6220125RC

New for 2022

6220 HP Series Solid Carbide - Drill Sizes 0.50 – 3.00mm

D Flute Dia. (mm)	D Dec. Equiv. Flute Dia. (inch)	Wire # Frac	d Shank Dia. (mm)	l1 Flute Length (mm)	l2 D Length (mm)	L Overall Length OAL (mm)	Uncoated (R) EDP No.	TiAIN Coated (RC) EDP No.
1.30	0.0512		3.0	15.6	18.7	50.0	6220130R	6220130RC
1.35	0.0531			16.2	19.4		6220135R	6220135RC
1.40	0.0551	54		16.8	20.2		6220140R	6220140RC
1.45	0.0571			17.4	20.9		6220145R	6220145RC
1.50	0.0591			18.0	21.6		6220150R	6220150RC
1.55	0.0610			18.6	22.3		6220155R	6220155RC
1.60	0.0630			19.2	23.0	6220160R	6220160RC	
1.65	0.0650			19.8	23.8	6220165R	6220165RC	
1.70	0.0669	51		24.0	24.5	6220170R	6220170RC	
1.75	0.0689			21.0	25.2	6220175R	6220175RC	
1.80	0.0709			21.6	25.9	6220180R	6220180RC	
1.85	0.0728	49		22.2	26.6	6220185R	6220185RC	
1.90	0.0748			22.8	27.4	6220190R	6220190RC	
1.95	0.0768			23.4	28.1	6220195R	6220195RC	
2.00	0.0787			24.0	28.8	6220200R	6220200RC	
2.10	0.0827			25.2	30.2	6220210R	6220210RC	
2.20	0.0866		26.4	31.7	6220220R	6220220RC		
2.30	0.0906		27.6	33.1	6220230R	6220230RC		
2.40	0.0945		28.8	34.6	6220240R	6220240RC		
2.50	0.0984		30	36.0	6220250R	6220250RC		
2.60	0.1024		31.2	37.4	6220260R	6220260RC		
2.70	0.1063		32.4	38.9	6220270R	6220270RC		
2.80	0.1102		33.6	40.3	6220280R	6220280RC		
2.90	0.1142		34.8	41.8	6220290R	6220290RC		
3.00	0.1181		36.0	43.2	6220300R	6220300RC		

6230 CT Series Coolant-Thru

15 x D – Depth of Cut 140°



10% COBALT
MICRO
GRAIN
CARBIDE

RH

140°
Point

30°
Helix

2
FLUTES

HARDNESS
1570=
HV30

h5

h5 Tolerance
2-Flutes Drill with
2 Helicoidal Internal Holes

- + 0.000/- 0.005mm (h5) Uncoated Version
- + 0.002/-0.0003mm Coated Version

High performance-coolant-thru micro drills with a strong web for maximum alignment and accuracy. Coolant-thru to optimize lubrication, chip removal and cooling. Ideal for a wide range of applications, medium and high tensile strength steels, stainless steel, titanium-alloys, cast iron. Standard sizes in 0.05mm increments, but intermediate sizes upon request.

Custom specifications such as:

- Point angles of 90°, 110°, 120°, 130° or other
- Special diameters as 2.03 mm or other
- Special tolerances as +/- 0.001 mm or other
- Minimum special order is 10 Pieces
- **Lead-time on customs 4 weeks ARO**
6 weeks with coating
- **Specials available up to 6mm diameter**

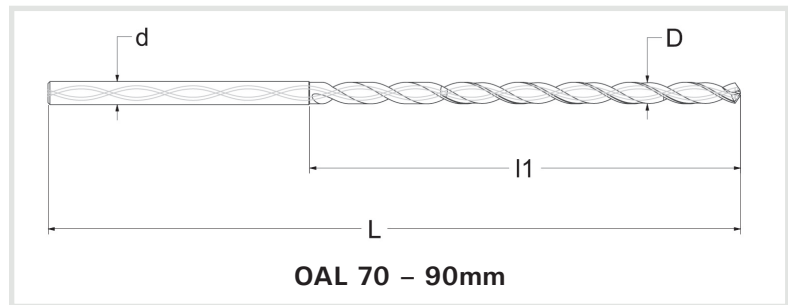

6230 CT Series Coolant-Thru - Drill Sizes 2.05 – 3.00mm

NOTE: Sold in single unit packages

D Flute Dia. (mm)	D Dec. Equiv. Flute Dia. (inch)	Wire # Frac	d Shank Dia. (mm)	l1 Flute Fength (mm)	L Overall Length OAL (mm)	TiAlN Coated (RC) EDP No.
2.05	0.0807		3.0	34	70.0	6230205RC
2.10	0.0827			36		6230210RC
2.15	0.0846			38		6230215RC
2.20	0.0866			40		6230220RC
2.25	0.0886			42		6230225RC
2.30	0.0906			44		6230230RC
2.35	0.0925			46		6230235RC
2.40	0.0945			48		6230240RC
2.45	0.0965			50	90.0	6230245RC
2.50	0.0984				6230250RC	
2.55	0.1004				6230255RC	
2.60	0.1024				6230260RC	
2.65	0.1043				6230265RC	
2.70	0.1063				6230270RC	
2.75	0.1083	36			6230275RC	
2.80	0.1102				6230280RC	
2.85	0.1122		6230285RC			
2.90	0.1142		6230290RC			
2.95	0.1161	32	6230295RC			
3.00	0.1181		6230300RC			

Features:

- For holes with depth 15x diameter
- Solid Tungsten Carbide Sub-micro grain with 2 helicoidal holes
- Right-cut, point geometry for self-centering
- Standard sizes in increments of 0.05mm
- Other diameters and lengths on request
- Available uncoated or TiAlN coated

Benefits:

- Higher drilling speed and longer tool life
- Suitable for specific materials
- High precision with h5 tolerances
- Strong, no deviation, maximum alignment accuracy
- Optimum cooling, lubrication and chip removal

All 6230 Series Drills sold in single unit packages

62FLX Series Solid Carbide

30-40xD – Depth of Cut 135°



h5 Tolerance Reinforced Shank d 3.0mm



+ 0.000/- 0.005mm (h5) Uncoated Version
 + 0.002/-0.0003mm Coated Version

High performance drill with reinforced shank at 3.00mm.

For use on small, deep holes and medium and tensile strength steels, stainless, titanium, alloys and cast iron.

High performance with outstanding surface finishes with strong core - no deviation.

All items can be quoted as left hand cut - contact us. Ideal for Medical applications.

Custom specifications such as:

- Size range from 0.30mm to 1.00mm
in increments of 0.05mm
- Intermediate sizes upon request
- For Drilling 30-40xD with Pecking Cycle Process
- H24° / 135°
- Shank Diameter 3.00 or 1/8" x OAL 50mm
- Special sizes and tolerances available
- Minimum custom order is 10 Pieces
- Other diameters and lengths on request
- Available in uncoated or TiAlN coated
- **Lead-time on custom orders—4 Weeks ARO**

NEW for 2022

62FLX Series Solid Carbide - Drill Sizes 0.30 – 1.00mm

NOTE: Sold in single unit packages

D Flute Dia. (mm)	D Dec. Equiv. Flute Dia. (inch)	d Shank Dia. (mm)	I1 Flute Length (mm)	I2 D Length (mm)	L Overall Length OAL (mm)	TiAlN Coated (RC) EDP No.
0.30	0.0118	3.0	3	12.0	50.0	62FLX030RC
0.35	0.0138		3.5	14.0		62FLX035RC
0.40	0.0157		4	16.0		62FLX040RC
0.45	0.0177		4.5	18.0		62FLX045RC
0.50	0.0197		5	20.0		62FLX050RC
0.55	0.0217		5.5	22.0		62FLX055RC
0.60	0.0236		6	24.0		62FLX060RC
0.65	0.0256		6.5	26.0	62FLX065RC	
0.70	0.0276		7	28.0	77.0	62FLX070RC
0.75	0.0295		7.5	30.0		62FLX075RC
0.80	0.0315		8	32.0		62FLX080RC
0.85	0.0335		8.5	34.0		62FLX085RC
0.90	0.0354		9	36.0		62FLX090RC
0.95	0.0374		9.5	38.0		62FLX095RC
1.00	0.0394	10	40.0	62FLX100RC		

Currently Non-Stock. Inventory Coming Soon.

3100 Series Short Solid Carbide 3 Flute Short Cross Drills

140°



h5 Tolerance Reinforced Shank d 3.0mm

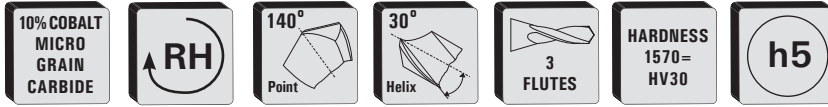

+ 0.000/- 0.005mm (h5)

High performance drill, 3-flutes for drilling and reaming in one operation.
For soft, medium and tensile strength steels, stainless, titanium, alloys and cast iron.
Good for transversal drilling with no burrs inside cut and strong web with no deviation.
Special, custom specification items available.

Custom specifications such as:

- Only available in right hand cut
- Size range from 0.5mm to 3.00mm in increments of 0.05 or 0.10mm
- Intermediate sizes upon request
- Special sizes and tolerances available
- Minimum Special Order is 10 Pieces
- **Lead-time on customs 4 weeks ARO**
6 weeks with coating

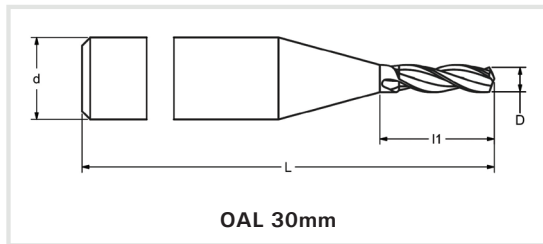

3100 Series Short Solid Carbide 3 Flute Short Cross Drills - Drill Sizes
 0.50 – 1.50mm
NOTE: Sold in single unit packages

D Flute Dia. (mm)	D Dec. Equiv. Flute Dia. (inch)	Wire # Frac	d Shank Dia. (mm)	l1 Flute Length (mm)	L Overall Length OAL (mm)	TiAlN Coated (RC) EDP No.
0.50	0.0197		3.0	3.0	30.0	3100050RC
0.55	0.0217					3100055RC
0.60	0.0236					3100060RC
0.65	0.0256					3100065RC
0.70	0.0276					3100070RC
0.75	0.0295					3100075RC
0.80	0.0315			3100080RC		
0.85	0.0335			3100085RC		
0.90	0.0354			3100090RC		
0.95	0.0374			3100095RC		
1.00	0.0394			3100100RC		
1.05	0.0413			3100105RC		
1.10	0.0433			3100110RC		
1.15	0.0453			3100115RC		
1.20	0.0472			3100120RC		
1.25	0.0492			3100125RC		
1.30	0.0512		3100130RC			
1.35	0.0531		3100135RC			
1.40	0.0551	54	5.0	3100140RC		
1.45	0.0571			3100145RC		
1.50	0.0591			3100150RC		

Feed & Speed indications for Titanium, Stainless, and Aluminum

*Feeds & Speeds are indications only and may vary depending on the process

	Cutting Speed Vc (m/min) / (SFM)	Feed per Revolution (mm) / (inch)				
		Diam 0,50-1,00	Diam 1,00-1,50	Diam 1,50-2,00	Diam 2,00-3,00	
Titanium	Uncoated	20-30 / 65-98	0,01-0,02 / 0.0004-0.0008	0,02-0,04 / 0.0008-0.0016	0,04-0,08 / 0.0016-0.0031	0,08-0,12 / 0.0031-0.0047
	Coated	30-40 / 98-131				
Stainless	Uncoated	30-40 / 98-131	0,02-0,04 / 0.0008-0.0016	0,04-0,06 / 0.0016-0.0024	0,06-0,10 / 0.0024-0.0039	0,10-0,15 / 0.0039-0.0059
	Coated	40-60 / 131-197				
Aluminum	Uncoated	100-150 / 328-492	0,03-0,05 / 0.0011-0.002	0,05-0,10 / 0.002-0.0039	0,10-0,20 / 0.0039-0.0079	0,20-0,30 / 0.0079-0.0118
	Coated	150-200 / 492-656				

3200 Series Long Solid Carbide 3 Flute Long Reamer Drills | 140°

h5 Tolerance Reinforced Shank d 3.0mm



+ 0.000/- 0.005mm (h5)

High performance drill, 3-flutes for drilling and reaming in one operation.
For soft, medium and tensile strength steels, stainless, titanium, alloys and cast iron.
Good for transversal drilling with no burrs inside cut and strong web with no deviation.
Special, custom specification items available.

Custom specifications such as:

- Only available in right hand cut
- Size range from 0.5mm to 3.00mm in increments of 0.05 or 0.10mm
- Intermediate sizes upon request
- Special sizes and tolerances available
- Minimum special order is 10 Pieces
- **Lead-time on customs 4 weeks ARO**
6 weeks with coating

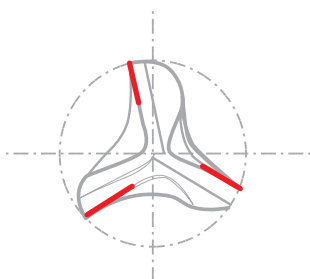
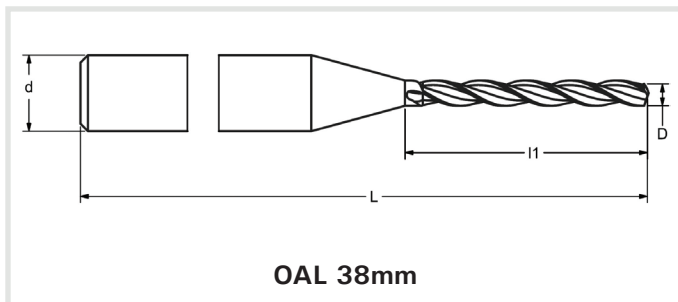

3 SHORT LIPS

Heat of cutting is absorbed by 3 short lips so perfect for hightense materials. 3 lips make thinner chips. Good for less burrs outside hole.

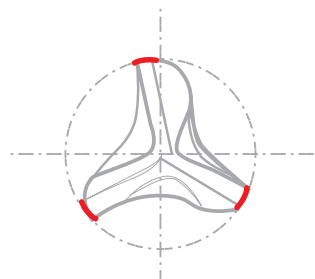

3 MARGINS

Drill is guided by 3 margins which make the drilling through hole straight. Circularity of hole is perfect with no ovalization.

3200 Series Long Solid Carbide 3 Flute Long Reamer Drills - Drill Sizes 0.50 – 3.00mm

NOTE: Sold in single unit packages

D Flute Dia. (mm)	D dec. equiv. flute dia. (inch)	Wire # Frac	d Shank Dia. (mm)	l1 Flute Length (mm)	L Overall Length OAL (mm)	TiAlN Coated (RC) EDP No.
0.50	0.0197		3.0	6.0	38	3200050RC
0.55	0.0217					3200055RC
0.60	0.0236					3200060RC
0.65	0.0256			3200065RC		
0.70	0.0276			3200070RC		
0.75	0.0295			3200075RC		
0.80	0.0315			3200080RC		
0.85	0.0335			3200085RC		
0.90	0.0354			3200090RC		
0.95	0.0374			3200095RC		
1.00	0.0394			3200100RC		
1.05	0.0413			3200105RC		
1.10	0.0433			3200110RC		
1.15	0.0453			3200115RC		
1.20	0.0472			3200120RC		
1.25	0.0492			3200125RC		
1.30	0.0512			3200130RC		
1.35	0.0531			3200135RC		
1.40	0.0551	54		3200140RC		
1.45	0.0571			3200145RC		
1.50	0.0591			3200150RC		
1.60	0.0630			3200160RC		
1.70	0.0669	51		3200170RC		
1.80	0.0709			3200180RC		
1.90	0.0748			3200190RC		
2.00	0.0787			3200200RC		
2.10	0.0827			3200210RC		
2.20	0.0866			3200220RC		
2.30	0.0906			3200230RC		
2.40	0.0945			3200240RC		
2.50	0.0984			3200250RC		
2.60	0.1024			3200260RC		
2.70	0.1063	36		3200270RC		
2.80	0.1102		3200280RC			
2.90	0.1142		3200290RC			
3.00	0.1181		3200300RC			

62H1 Gun Drill - Single Flute Helicoidal Drills

10 x D – Depth of Cut 120°

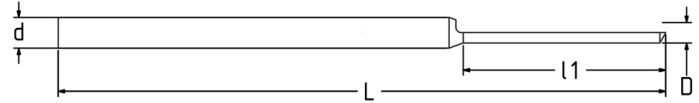
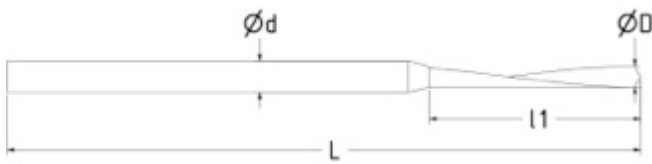

For polycarbonates, soft materials, brass & copper

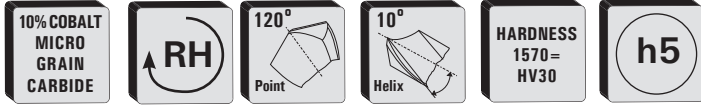

For soft materials, brass, copper, stainless.

Direct drilling, no centering required.

Single lip works close to hole center so chip cutting is easier.

Good for reaming operation. Can be used as a reamer.

Custom specifications such as:

- Range from D0.50 to D1.50 - increments of 0.05 mm
- Intermediate sizes upon request
- Special sizes, point angles and tolerances available
- Minimum custom order is 10 Pieces



NEW for 2022

62H1 Gun Drill Z1 Helicoidal - Drill Sizes 0.50–1.50mm

NOTE: Sold in 5 piece packages only

D (mm)	D (inch)	Flute Length (mm)	Shank Diameter (mm)	AOL L (mm)	EDP No.
0.50	0.0197	5.00	1.50	30	62H1050R
0.55	0.0217	5.50	1.50	30	62H1055R
0.60	0.0236	6.00	1.50	30	62H1060R
0.65	0.0256	6.50	1.50	30	62H1065R
0.70	0.0276	7.00	1.50	30	62H1070R
0.75	0.0295	7.50	1.50	30	62H1075R
0.80	0.0315	8.00	1.50	30	62H1080R
0.85	0.0335	8.50	1.50	30	62H1085R
0.90	0.0354	9.00	1.50	30	62H1090R
0.95	0.0374	9.50	1.50	30	62H1095R
1.00	0.0394	10.00	1.50	30	62H1100R
1.05	0.0413	10.50	1.50	30	62H1105R
1.10	0.0433	11.00	1.50	30	62H1110R
1.15	0.0453	11.50	1.50	30	62H1115R
1.20	0.0472	12.00	1.50	30	62H1120R
1.25	0.0492	12.50	1.50	30	62H1125R
1.30	0.0512	13.00	1.50	30	62H1130R
1.35	0.0531	13.50	1.50	30	62H1135R
1.40	0.0551	14.00	1.50	30	62H1140R
1.45	0.0571	14.50	1.50	30	62H1145R
1.50	0.0591	15.00	1.50	30	62H1150R

Currently Non-Stock Item. Inventory Coming Soon.

Speeds and Feeds Chart

Cutting Speed - RPM = 3.82 x SFM / Drill Dia.

Feed Rate - IPM = RPM X IPR

Guidelines - Not Guaranteed

Material	Diameter (mm)	Speed (sfm)	Feed Rate (lpr)
Mild and Low Carbon Steels	0.10 – 0.50	40 – 80	0.0002 – 0.0003
	0.51 – 0.70	80 – 140	0.0003 – 0.0004
	0.71 – 0.99	140 – 200	0.0004 – 0.0006
	1.00 – 2.00	140 – 200	0.0006 – 0.0016
	2.01 – 3.00	140 – 200	0.0016 – 0.0020
High Carbon, Alloy Steels	0.10 – 0.50	30 – 70	0.0002 – 0.0003
	0.51 – 0.70	70 – 100	0.0002 – 0.0004
	0.71 – 0.99	70 – 100	0.0004 – 0.0006
	1.00 – 2.00	100 – 170	0.0006 – 0.0016
	2.01 – 3.00	100 – 170	0.0014 – 0.0020
Stainless Steels – 300 Series, 17-4	0.10 – 0.50	20 – 40	0.0001 – 0.0002
	0.51 – 0.70	40 – 70	0.0002 – 0.0003
	0.71 – 0.99	70 – 120	0.0002 – 0.0003
	1.00 – 2.00	70 – 120	0.0003 – 0.0010
	2.01 – 3.00	70 – 120	0.0008 – 0.0014
Stainless Steels – 400 Series	0.10 – 0.50	30 – 60	0.0001 – 0.0002
	0.51 – 0.70	60 – 90	0.0002 – 0.0003
	0.71 – 0.99	90 – 140	0.0003 – 0.0004
	1.00 – 2.00	90 – 140	0.0004 – 0.0012
	2.01 – 3.00	90 – 140	0.0010 – 0.0018
Cast Iron	0.10 – 0.50	70 – 160	0.0002 – 0.0003
	0.51 – 0.70	160 – 200	0.0003 – 0.0004
	0.71 – 0.99	200 – 340	0.0004 – 0.0008
	1.00 – 2.00	200 – 340	0.0008 – 0.0020
	2.01 – 3.00	200 – 340	0.0016 – 0.0026
Ductile Iron	0.10 – 0.50	60 – 100	0.0001 – 0.0002
	0.51 – 0.70	100 – 140	0.0002 – 0.0003
	0.71 – 0.99	140 – 270	0.0003 – 0.0006
	1.00 – 2.00	140 – 270	0.0006 – 0.0016
	2.01 – 3.00	140 – 270	0.0014 – 0.0024
Aluminum	0.10 – 0.50	80 – 170	0.0002 – 0.0003
	0.51 – 0.70	170 – 270	0.0003 – 0.0005
	0.71 – 0.99	270 – 400	0.0005 – 0.0008
	1.00 – 2.00	270 – 400	0.0008 – 0.0024
	2.01 – 3.00	270 – 400	0.0020 – 0.0031
High Alloys – Inconel, Titanium	0.10 – 0.50	30 – 70	0.0001 – 0.0002
	0.51 – 0.70	70 – 100	0.0002 – 0.0003
	0.71 – 0.99	100 – 170	0.0003 – 0.0004
	1.00 – 2.00	100 – 170	0.0004 – 0.0012
	2.01 – 3.00	100 – 170	0.0010 – 0.0018

NOTE: Cutting parameters are good for series 5100 cobalt, 6000 & 3000 carbide drills

PILOT

Precision Products

Best-in-class brands, outstanding customer service and fast, reliable delivery

Pilot Precision Products is the world's largest supplier of industrial broaches and small, round cutting tools from duMONT MinuteMan® Industrial Broaches, Hassay Savage, duMONT CNC Indexable Broaching System, Magafor® and GMauvaisUSA™.

Pilot Precision Products balances time-honored traditions with innovative manufacturing techniques in all its offerings. As a result, customers can trust that exceptional service from each company will remain the same.



World's largest supplier of keyway broaches

The duMONT Company has been designing and manufacturing precision broaches since 1945. Minute Man® Broaches are recognized all over the world for quality, durability and engineering detail. All are manufactured of the finest quality high-speed steel.

duMONT CNC Indexable Broaching System

The duMONT CNC Indexable Broaching System offers a wide range of products that provide the opportunity to manufacture parts more efficiently and accurately through single machine processing. This includes CNC Lathes, Milling Machines, Motorized Slotter and many CNC Broaching Systems. To complement all tools, we offer many accessories to make your project run effortlessly.



World's leader and largest supplier in center drills, spot drills, micro to standard size reamers, countersinks, multi-function tools and micro end mills

Magafor can resolve any centering, chamfering, micro-milling or reaming issues you may be experiencing with top-quality products available in HSS-Cobalt or Carbide. Their Multi-V can reduce machining times and tool set-ups; one tool, one holder, ten applications. Pilot is the exclusive American distributor of Magafor products.



World's leader in rotary and index broaching

Hassay Savage products have five decades of engineering expertise behind them. If you're looking for critically accurate cuts, look no further. Choose from push, pull and rotary broaches with TiN and TiAlN coating. Big jobs come in small parts. Let us be your partner in unique cutting applications.



Highly specialized precision micro drills

GMauvaisUSA™ is known for worldwide for superior precision, quality, consistency and performance. Notably, micro drills from the brand afford extraordinary concentricity, circularity and straightness within .00008". As the exclusive American distributor of GMauvais products, Pilot can bring GMauvaisUSA™ precision to you and your projects.

In addition to our robust off-the-shelf product offerings, customers often call on us for custom tooling. When such a request comes in, we never shy away from that challenge. In fact, we enjoy working to create a unique and highly productive solution.



PILOT



Pilot Precision Products is the world's largest manufacturer and supplier of industrial broaches from duMONT MinuteMan® Industrial Broaches and Hassay Savage broaching tools, after a recent merger of these two top brands. Pilot Precision Products is also the leading supplier of small, round cutting tools and is the exclusive American master wholesaler of Magafor® and GMauvaisUSA™ products.

Located in Western Massachusetts, an area long known as a manufacturing hub for complex machining, Pilot Precision Products balances time-honored traditions with innovative manufacturing techniques in all its offerings, and only partners with like-minded brands. As a result, customers trust the best-in-class, durable and reliable products that the manufacturer couples with outstanding customer service and fast, reliable delivery.

Distributed by:

15 Merrigan Way | South Deerfield, MA 01373
413-350-5200 | PilotPrecision.com
ISO 9001:2015

PILOT 
Precision Products